



EMC TEST REPORT For RCM

Test Report No. : KES-E1-19T0482
Date of Issue : Aug. 19, 2019
Product name : Pentabrid DVR (Digital Video Recorder)
Model/Type No. : HRX-1621P
Variant Model : -
Applicant : Hanwha Techwin Co., Ltd.
Applicant Address : 6, Pangyo-ro 319 Beon-gil, Bundang-gu, Seongnam-si,
Gyeonggi-do, 13488, KOREA
Manufacturer : 1. HANWHA TECHWIN(TIANJIN) CO., LTD
2. HANWHA TECHWIN SECURITY VIETNAM CO.,LTD.
3. D-TECH CO.,LTD.
Manufacturer Address : 1. No.11 Weiliu Rd, Micro-Electronic Industrial Park, TEDA, Tianjin,
300385, People's Republic of China
2. Lot O-2, Que Vo Industrial Zone extended area,
Nam Son commune, Bac Ninh city, Bac Ninh province, Vietnam
3. 173-25, Saneop-ro, Gwonseon-gu, Suwon-si, Gyeonggi- do,
Korea (Suwon Industrial Complex)
Date of Receipt : Jul. 25, 2019
Test date : Aug. 12, 2019 ~ Aug. 13, 2019
Test Results : In Compliance Not in Compliance

Tested by

Min Seong, Kim
EMC Test Engineer

Reviewed by

Dong-Hun, Jang
EMC Technical Manager

This test report is not related to KS Q ISO/IEC 17025 and KOLAS.

This report shall not be reproduced except in full, without the written approval of KES Co., Ltd.
The results shown in this test report refer only to the sample(s) tested unless otherwise stated.
The authenticity of the test report, contact shchoi@kes.co.kr



KES Co., Ltd.

3701, 40, Simin-daero 365beon-gil,
Dongan-gu, Anyang-si, Gyeonggi-do, 14057, Korea
Tel: +82-31-425-6200 / Fax: +82-31-424-0450
www.kes.co.kr

Report No.:
KES-E1-19T0482
Page (2) of (36)

REPORT REVISION HISTORY

Date	Test Report No.	Revision History
Aug. 19, 2019	KES-E1-19T0482	Issued

This report shall not be reproduced except in full, without the written approval of KES Co., Ltd. This document may be altered or revised by KES Co., Ltd. personnel only, and shall be noted in the revision section of the document. Any alteration of this document not carried out by KES Co., Ltd. will constitute fraud and shall nullify the document.

This report shall not be reproduced except in full, without the written approval of KES Co., Ltd.
The results shown in this test report refer only to the sample(s) tested unless otherwise stated.
The authenticity of the test report, contact shchoi@kes.co.kr



TABLE OF CONTENTS

1.0	General Product Description.....	4
1.1	Test Voltage & Frequency	7
1.2	Variant Model Differences.....	7
1.3	Device Modifications	7
1.4	Equipment Under Test.....	7
1.5	Support Equipments	8
1.6	External I/O Cabling	9
1.7	EUT Operating Mode(s)	9
1.8	Configuration.....	10
1.9	Remarks when standards applied	11
1.10	Calibration Details of Equipment Used for Measurement	11
1.11	Test Facility	11
1.12	Laboratory Accreditations and Listings	11
2.0	Test Regulations.....	12
2.1	Conducted Emissions at Mains Power Ports	14
2.2	Conducted Emissions at Telecommunication Ports.....	15
2.3	Radiated Electric Field Emissions(Below 1 GHz)	16
2.4	Radiated Electric Field Emissions(Above 1 GHz)	17
APPENDIX A – TEST DATA.....		18
	Conducted Emissions at Mains Power Ports.....	18
	Conducted Emissions at Telecommunication Ports	20
	Radiated Electric Field Emissions(Below 1 GHz)	23
	Radiated Electric Field Emissions(Above 1 GHz)	24
	Test Setup Photos and Configuration	25
	Conducted Voltage Emissions	25
	Conducted Telecommunication Emissions	26
	Radiated Electric Field Emissions(Below 1 GHz)	27
	Radiated Electric Field Emissions(Above 1 GHz)	28
	EUT External Photographs.....	29
	EUT Internal Photographs	30



1.0 General Product Description

Main Specifications of EUT are:

Video			
Video Input	Analog Camera	Input	16CH, 1Vp-p 75ohm, BNC
		Signal Type	AHD(8MP, 5MP, 4MP, 1080p, 720p) HDTVI(8MP, 5MP, 4MP, 1080p, 720p) HDCVI(5MP, 4MP, 1080p, 720p) CVBS (NTSC/PAL)
	Network Camera	Input	2CH (up to 18CH)
		Resolution	CIF ~ 8MP
		Protocols	SUNAPI(Wisenet), ONVIF
Live	Local Display		1x HDMI, 1x VGA dual monitor
Operating System	Embedded		Linux
Recording	Compression		H.265, H.264, MJPEG
	Record Rate(Analog)		- Analog Camera(NTSC/PAL) (Main Stream) 8MP 8/8fps CH, 5M 12/12fps CH, 4M 15/12fps CH, 2M 30/25fps CH, 720p 30/25fps/CH, SD 30/25fps/CH (Sub Stream) HD: 640x360 full fps/CH, SD: upto SD full fps/CH *The maximum recording frame rate depends on the frame rate of the input camera.
	Mode		Manual, Schedule (Continuous/Event), Event(Pre/Post), Dual Track
	Event Trigger		Alarm Input Analog Camera Video Loss, Motion Detection, Tampering Network Camera Camera Event (Sensor, MD, Video analytics), VA event (Tampering, Enter / Exit, Passing, Virtual-line, (Dis)Appear, Face Detection, Audio detection), Defocus camera event
	Event Action		E-mail, PTZ preset, Alarm out, Buzzer, Monitor out
	Overwrite modes		Overwrite On/Off

This report shall not be reproduced except in full, without the written approval of KES Co., Ltd.
 The results shown in this test report refer only to the sample(s) tested unless otherwise stated.
 The authenticity of the test report, contact shchoi@kes.co.kr



KES Co., Ltd.

3701, 40, Simin-daero 365beon-gil,
 Dongan-gu, Anyang-si, Gyeonggi-do, 14057, Korea
 Tel: +82-31-425-6200 / Fax: +82-31-424-0450
 www.kes.co.kr

Report No.:
 KES-E1-19T0482
 Page (5) of (36)

Search & Playback	Performance		Max. 4 users (Set 1, Remote 3)
	Resolution		CIF ~ 8MP
	Playback Control		Fast Forward/Backward (x2,x4,x8,x16,x32,x64, x128, x256) Slow Forward/Backward (x1/2,x1/4,x1/8) ※Move one step up/down
	Internal		Up to 8 SATA HDDs Max. 6TB/HDD(TBD)
Storage	External		USB(for Backup)
	File Format		BU(DVR Player), SEC(Set, Include Player), AVI(Webviewer only)
NETWORK			
Protocol support			TCP/IP, UDP/IP, RTP (UDP), RTP (TCP), RTSP, NTP, HTTP, DHCP (Server, Client), PPPoE, SMTP, ICMP, IGMP, ARP, DNS, DDNS, uPnP, HTTPS, SNMP, ONVIF (Profile-S), SUNAPI(Server, Client)
Max. Remote users			Search (3), Live Unicast (10), Multicast (20)
Security			IPv4/v6
Security			IP address filtering, User access log, 802.1x Authentication, Encryption (ID/PW, Recording, Transmission, Backup)
OS			Supported OS : Window XP (Service pack 2 or above), Vista, 7, 8, 10, Mac OS X (10.7 or above)
Web Browser			Google Chrome 47 or above, MS Edge 20 or above, Safari 9 or above *support Plug-in free Web
Viewer Software			SSM, Webviewer, SmartViewer, Wisenet Mobile Viewer
CMS Support			SDK/CGI(SUNAPI)
Function			
Easy Configuration			Setup Wizard (Language Date/Time, Password, Network, Auto Camera Configuration), P2P (QR code)
ARB (Auto Recovery Backup)			support
PTZ	Control/Preset		Via GUI & RS-485, Webviewer, SPC-7000 / 300 presets
Smart phone	OS / Protocol support		Android , iOS, RTP, RTSP, HTTP, CGI(SUNAPI)
	Control		Live(16ch) : Multi-Profile Support Playback(1CH, Max. 2MP) Event push
System Control			Mouse, IR Remocon, Web, SPC-7000

This report shall not be reproduced except in full, without the written approval of KES Co., Ltd.
 The results shown in this test report refer only to the sample(s) tested unless otherwise stated.
 The authenticity of the test report, contact shchoi@kes.co.kr



KES Co., Ltd.

3701, 40, Simin-daero 365beon-gil,
 Dongan-gu, Anyang-si, Gyeonggi-do, 14057, Korea
 Tel: +82-31-425-6200 / Fax: +82-31-424-0450
 www.kes.co.kr

Report No.:
 KES-E1-19T0482
 Page (6) of (36)

INDICATOR / INTERFACE		
Front	Indicator	Power status LED 1ea, HDD Action LED 1ea, Alarm Status LED 1ea Record status LED 1ea, Network Action LED 1ea, Backup LED 1ea
Monitors	Mode	HDMI/VGA Dual Monitor
	HDMI	1 HDMI (4K(3840 x 2160), 2K(2560 x 1440), 1920x1080, 1280x1024, 1280x720)
	VGA	1 VGA (1920x1080, 1280x1024, 1280x720)
	Composite(Spot)	BNC(1CH) ※ Included OSD On Screen, Single, Multi, Auto Change mode Support
Audio	Inputs/Output	16CH line in (Built in 4CH, Option : Audio Extension Cable)/ 1CH line out
	Compression	G.711
	Sampling rate	8KHz
Alarm	Inputs/Outputs	Terminal 16 Inputs (NO/NC) / Terminal 4 relay Outputs (NO/NC & NO) MAX DC18V, 2A, Typical DC12V, 2A
Ethernet		1 RJ45 10/100/1000 Base-T
USB		1 ports(USB 3.0, Rear), 1 ports(USB 2.0, Front)
Serial		RS-485(Full Duplex) for PTZ, Samsung System Keyboard
Coaxia Control		Support (CVBS and AHD/CVI/TVI)
Reset		Yes(Factory Reset, Alarm Reset)
General		
Electrical	Input Voltage/Current	100 ~ 240 VAC ±10%; 50/60 Hz
	Power consumption	(TBD) Max. W
Environmental	Operating Temperature/Humidity	+0°C to +40°C (+32°F to +104°F) / 20% to 85% RH
Mechanical	Color / Material	Black / Metal
	Dimension (W x H x D)	(TBD) W440 x H88 x D384.8(17.32" x 3.46" x 15.15")
	Weight (with hard disks)	TBD kg

This report shall not be reproduced except in full, without the written approval of KES Co., Ltd.
 The results shown in this test report refer only to the sample(s) tested unless otherwise stated.
 The authenticity of the test report, contact shchoi@kes.co.kr



1.1 Test Voltage & Frequency

Unless indicated otherwise on the individual data sheet or test results, the test voltage and frequency was as indicated below.

Voltage 240 Vac 100 Vac 24 Vac 12 Vdc PoE

Frequency 50 Hz 60 Hz Hz

1.2 Variant Model Differences

Not applicable

1.3 Device Modifications

Not applicable

1.4 Equipment Under Test

Description	Model Number	Serial Number	Manufacturer	Remarks
Pentabrid DVR (Digital Video Recorder)	HRX-1621P	-	HANWHA TECHWIN(TIANJIN) CO., LTD	EUT
Mouse	MOKJUO	-	Primax Electronics Ltd.	-
HDD	WD40PUEX-64N96Y0	-	Western Digital	4 TB

This report shall not be reproduced except in full, without the written approval of KES Co., Ltd.
The results shown in this test report refer only to the sample(s) tested unless otherwise stated.
The authenticity of the test report, contact shchoi@kes.co.kr



1.5 Support Equipments

Description	Model Number	Serial Number	Manufacturer	Remarks
Camera	SDC-79446BF	-	HANWHA TECHWIN(TIANJIN) CO., LTD	-
Camera Adapter	FSP-060-DIBAN2	-	Zhonghan Electronics(Shenzhen) Co., Ltd.	-
Monitor 1	SMT-2233	ZC6U67VH500194D	Weihai Daewoo Electronics Co., Ltd.	-
Monitor 2	SMT-2232	C95V67VF900038B	Weihai Daewoo Electronics Co., Ltd.	-
Monitor 3	SMT-2232	C95V67VF900015Y	Weihai Daewoo Electronics Co., Ltd.	-
Notebook	NT730U3E	JJRE91CF200065A	Samsung Electronics	-
Notebook Adapter	PA-1600-66	AD-6019P	LITEON	-
Speaker	BR10000A CUVE	-	BEIJING EDIFIER HI- TECH GROUP.	-
MIC 1	CMK-303	-	CAMAC	-
MIC 2	MP1000	-	-	-
Controller	SPC-1010	C50E67WG10100F	SamSung Techwin Co.,Ltd.	-
Controller Adapter	RS-AB1000	-	Dongguan Jinhua sheng Power Technology Co.,Ltd.	-
Alarm	-	-	-	-
Button Alarm	-	-	-	-
USB Memory	-	-	SONY	16 GB

This report shall not be reproduced except in full, without the written approval of KES Co., Ltd.
The results shown in this test report refer only to the sample(s) tested unless otherwise stated.
The authenticity of the test report, contact shchoi@kes.co.kr



1.6 External I/O Cabling

Start		END		Cable Spec.	
Description	I/O Port	Description	I/O Port	Length	Shield
Pentabrid DVR (Digital Video Recorder) (EUT)	VIDEO IN	Camera	BNC	10.0	U
	HDMI	Monitor 1	HDMI	1.5	S
	VGA OUT	Monitor 2	D-SUB	1.5	S
	SPOT	Monitor 3	BNC	3.0	S
	NETWORK	Notebook	RJ-45	3.0	U
	AUDIO OUT	Speaker	RCA	1.6	U
	AUDIO IN	MIC 1	RCA	1.6	U
	AUDIO IN (2 Pin)	MIC 2	XLR	1.7	U
	RS-485	Controller	RS-485	10.0	U
	Alarm Out	Alarm	Alarm In	10.0	U
	Alarm In	Button Alarm	Alarm Out	10.0	U
	USB 2.0	Mouse	USB	1.3	U
	USB 3.0	USB Memory	USB	-	-

* Unshielded=U, Shielded=S

1.7 EUT Operating Mode(s)

Test mode	operating
OP	EUT Monitoring, Ping Test

EUT Test operating S/W		
Name	Version	Manufacture Company
WebViewr	-	-

This report shall not be reproduced except in full, without the written approval of KES Co., Ltd.
 The results shown in this test report refer only to the sample(s) tested unless otherwise stated.
 The authenticity of the test report, contact shchoi@kes.co.kr

1.8 Configuration

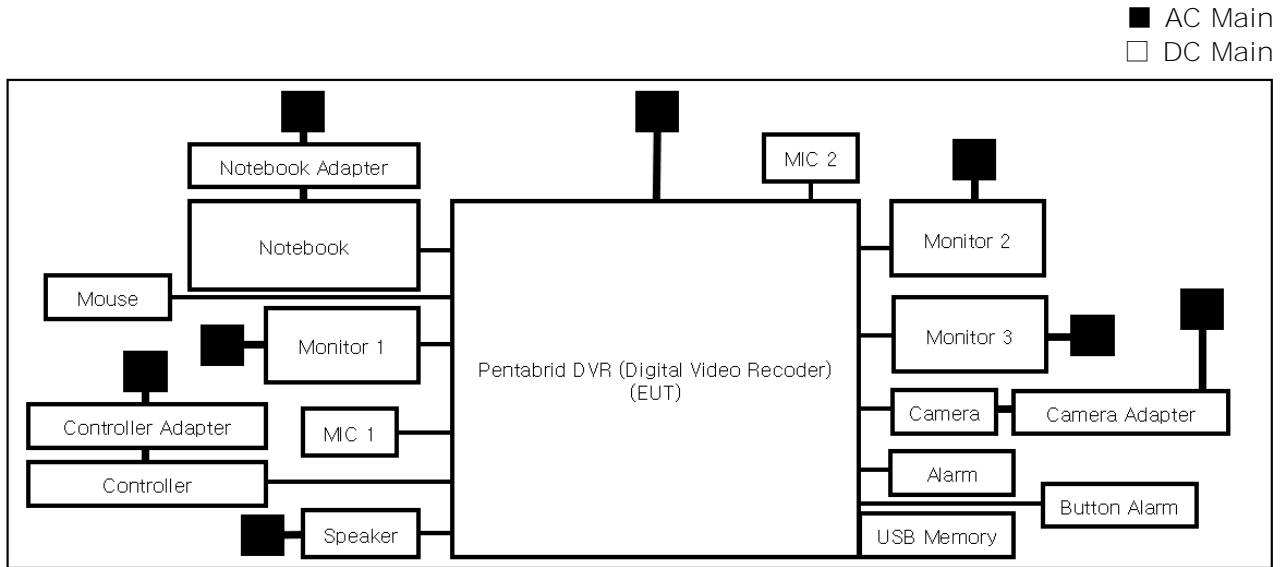

This report shall not be reproduced except in full, without the written approval of KES Co., Ltd.
 The results shown in this test report refer only to the sample(s) tested unless otherwise stated.
 The authenticity of the test report, contact shchoi@kes.co.kr

1.9 Remarks when standards applied

The eSATA port is not tested, because it is not used.





1.10 Calibration Details of Equipment Used for Measurement

Test equipment and test accessories are calibrated on regular basis. The maximum time between calibrations is one year or what is recommended by the manufacturer, whichever is less.

1.11 Test Facility

The measurement facility is located at 473-21 Gayeo-ro, Yeosu-si, Gyeonggi-do, 12658, Korea. The sites are constructed in conformance with the requirements of ANSI C63.4:2014 and CISPR 16-1-4:2012

1.12 Laboratory Accreditations and Listings

Country	Agency	Scope of Accreditation	Logo
KOREA	RRA	EMI (3 m & 10 m Semi-Anechoic Chamber , 10 m Open Area and conducted test site) EMS (ESD, RS, EFT/Burst, Surge, CS, Magnetic, Dips and interruptions)	 KR0100
International	KOLAS	EMI (3 m & 10 m Semi-Anechoic Chamber , and conducted test site) EMS (ESD, RS, EFT/Burst, Surge, CS, Magnetic, Dips and interruptions)	 KT489
USA	FCC	3 m & 10 m Semi-Anechoic Chamber, 10 m Open Area and Conducted test site to perform FCC Part 15/18 measurements.	 KR0100
Canada	ISED	3 m & 10 m Semi-Anechoic Chamber and Conducted test site	 23298-1
JAPAN	VCCI	Mains Ports Conducted Interference Measurement, Telecommunication Ports Conducted Disturbance Measurement and Radiation 10 meter site, Facility for measuring radiated disturbance above 1 GHz	 R-20056, C-20036, T-20040, G-20057
Europe	TÜ V SÜ D	EMI (3 m & 10 m Semi-Anechoic Chamber , 10 m Open Area and conducted test site) EMS (ESD, RS, EFT/Burst, Surge, CS, Magnetic, Dips and interruptions)	 CARAT 001633 0003

2.0 Test Regulations

The emissions tests were performed according to following regulations:

- EMC – Directive 2014/30/EU

- EN 61000-6-3: 2011
- EN 61000-6-1: 2007
- EN 61000-6-4: 2007 +A1: 2011
- EN 61000-6-2: 2005
- EN 55011: 2007 +A1: 2010 Group 1 Group 2
 Class A Class B
- EN 55014-1: 2006 +A2: 2011
- EN 55014-2: 1997 +A2: 2008
- EN 55015: 2013
- EN 55032: 2015 Class A Class B
- EN 55024: 2010
- EN 50130-4: 2011 +A1: 2014
- EN 61000-3-2: 2014
- EN 61000-3-3: 2013
- EN 61326-1: 2013



-
- | | | |
|---|---|----------------------------------|
| <input type="checkbox"/> VCCI -CISPR 32:2016 | <input type="checkbox"/> Class A | <input type="checkbox"/> Class B |
| <input checked="" type="checkbox"/> AS/NZS CISPR32:2015 | <input checked="" type="checkbox"/> Class A | <input type="checkbox"/> Class B |
| <input type="checkbox"/> 47 CFR Part 15, Subpart B | | |
| <input type="checkbox"/> CISPR 22:2009 +A1:2010 | <input type="checkbox"/> Class A | <input type="checkbox"/> Class B |
| <input type="checkbox"/> ANSI C63.4-2009 | | |
| <input type="checkbox"/> IC Regulation ICES-003 : 2016 | | |
| <input type="checkbox"/> CAN/CSA CISPR 22-10 | <input type="checkbox"/> Class A | <input type="checkbox"/> Class B |
| <input type="checkbox"/> ANSI C63.4-2014 | | |
| <input type="checkbox"/> RE- Directive 2014/53/EU | | |
| <input type="checkbox"/> EN 301 489-1 V1.9.2 | | |
| <input type="checkbox"/> Equipment for fixed use | | |
| <input type="checkbox"/> Equipment for vehicular use | | |
| <input type="checkbox"/> Equipment for portable use | | |
| <input type="checkbox"/> EN 301 489-3 V1.6.1 | | |
| <input type="checkbox"/> EN 301 489-17 V2.2.1 | | |
| <input type="checkbox"/> EN 60945:2002 | | |

This report shall not be reproduced except in full, without the written approval of KES Co., Ltd.
The results shown in this test report refer only to the sample(s) tested unless otherwise stated.
The authenticity of the test report, contact shchoi@kes.co.kr



2.1 Conducted Emissions at Mains Power Ports

Test Date
Aug. 12, 2019

Test Location
Electro wave Shieldroom #6

Test Equipment

Used	Description	Model Number	Manufacturer	Serial Number	Cal. Due
<input checked="" type="checkbox"/>	EMI Test S/W	EMC32	R & S	9.12.00	-
<input checked="" type="checkbox"/>	EMI TEST RECEIVER	ESR3	R & S	101781	04, 22, 2020
<input checked="" type="checkbox"/>	LISN	ENV216	R & S	101787	01, 04, 2020
<input checked="" type="checkbox"/>	LISN	ESH2-Z5	R & S	100450	04, 22, 2020
<input checked="" type="checkbox"/>	PULSE LIMITER	ESH3-Z2	R & S	101915	11, 26, 2019

Test Conditions

Temperature: 23,3 °C
Relative Humidity: 54,5 % R.H.

Frequency Range of Measurement
150 kHz to 30 MHz

Instrument Settings
IF Band Width: 9 kHz

Test Results
The requirements are:

- PASS
- NOT PASS
- NOT APPLICABLE

Remarks
See Appendix A for test data.



2.2 Conducted Emissions at Telecommunication Ports

Test Date
Aug. 12, 2019

Test Location
Electro wave Shieldroom #6

Test Equipment

Used	Description	Model Number	Manufacturer	Serial Number	Cal. Due
<input checked="" type="checkbox"/>	EMI Test S/W	EMC32	R & S	9.12.00	-
<input checked="" type="checkbox"/>	EMI TEST RECEIVER	ESR3	R & S	101781	04, 22, 2020
<input checked="" type="checkbox"/>	LISN	ENV216	R & S	101787	01, 04, 2020
<input checked="" type="checkbox"/>	LISN	ESH2-Z5	R & S	100450	04, 22, 2020
<input checked="" type="checkbox"/>	PULSE LIMITER	ESH3-Z2	R & S	101915	11, 26, 2019
<input checked="" type="checkbox"/>	8-WIRE ISN CAT3,5	ENY81	R & S	100174	01, 07, 2020
<input checked="" type="checkbox"/>	8-WIRE ISN CAT6	ENY81-CAT6	R & S	101665	01, 07, 2020

Test Conditions

Temperature: 23,3 °C
Relative Humidity: 54,5 % R.H.

Frequency Range of Measurement
150 kHz to 30 MHz

Instrument Settings

IF Band Width: 9 kHz

Test Results

The requirements are:

- PASS
- NOT PASS
- NOT APPLICABLE

Remarks

See Appendix A for test data.



2.3 Radiated Electric Field Emissions(Below 1 GHz)

Test Date
Aug. 12, 2019

Test Location
 OPEN AREA TEST SITE #2 SEMI ANECHOIC CHAMBER #4(10 m)

Test Equipment

Used	Description	Model Number	Manufacturer	Serial Number	Cal. Due
<input checked="" type="checkbox"/>	EMI Test S/W	EP5/RE	TOYO Corporation	6.0.0	-
<input checked="" type="checkbox"/>	EMI TEST RECEIVER	ESU26	R & S	100551	04, 09, 2020
<input checked="" type="checkbox"/>	AMPLIFIER	SCU 01	R & S	100603	11, 26, 2019
<input checked="" type="checkbox"/>	TRILOG-BROADBAND ANTENNA	VULB9163	Schwarzbeck	715	11, 29, 2020
<input checked="" type="checkbox"/>	ATTENUATOR	8491A	HP	32173	03, 11, 2020

Test Conditions
Temperature: 23,9 °C
Relative Humidity: 54,1 % R.H.

Frequency Range of Measurement
30 MHz to 1 GHz

Instrument Settings
IF Band Width: 120 kHz

Test Results
The requirements are:

- PASS
- NOT PASS
- NOT APPLICABLE

Remarks
See Appendix A for test data.



2.4 Radiated Electric Field Emissions(Above 1 GHz)

Test Date
Aug. 13, 2019

Test Location
SEMI ANECHOIC CHAMBER #3

Test Equipment

Used	Description	Model Number	Manufacturer	Serial Number	Cal. Due
<input checked="" type="checkbox"/>	EMI Test S/W	EP5/RE	TOYO Corporation	6.0.0	-
<input checked="" type="checkbox"/>	EMI TEST RECEIVER	ESR7	R & S	101190	08, 06, 2019
<input checked="" type="checkbox"/>	PREAMPLIFIER	8449B	AGILENT	3008A01967	05, 27, 2020
<input type="checkbox"/>	ATTENUATOR	8491A	HP	35496	03, 11, 2020
<input checked="" type="checkbox"/>	DOUBLE RIDGED HORN ANTENNA	SAS-571	A.H.SYSTEM,INC	781	03, 12, 2021

Test Conditions

Temperature: 24,6 °C
Relative Humidity: 54,5 % R.H.

Frequency Range of Measurement

1 GHz to 6 GHz

Instrument Settings

IF Band Width: 1 MHz

Test Results

The requirements are:

- PASS
- NOT PASS
- NOT APPLICABLE

Remarks

See Appendix A for test data.



APPENDIX A – TEST DATA

Conducted Emissions at Mains Power Ports

HOT LINE

Common Information

Test Description:	Conducted Emission
Model No.:	HRX-1621P
Phase:	
Mode:	H
Operator Name:	KES

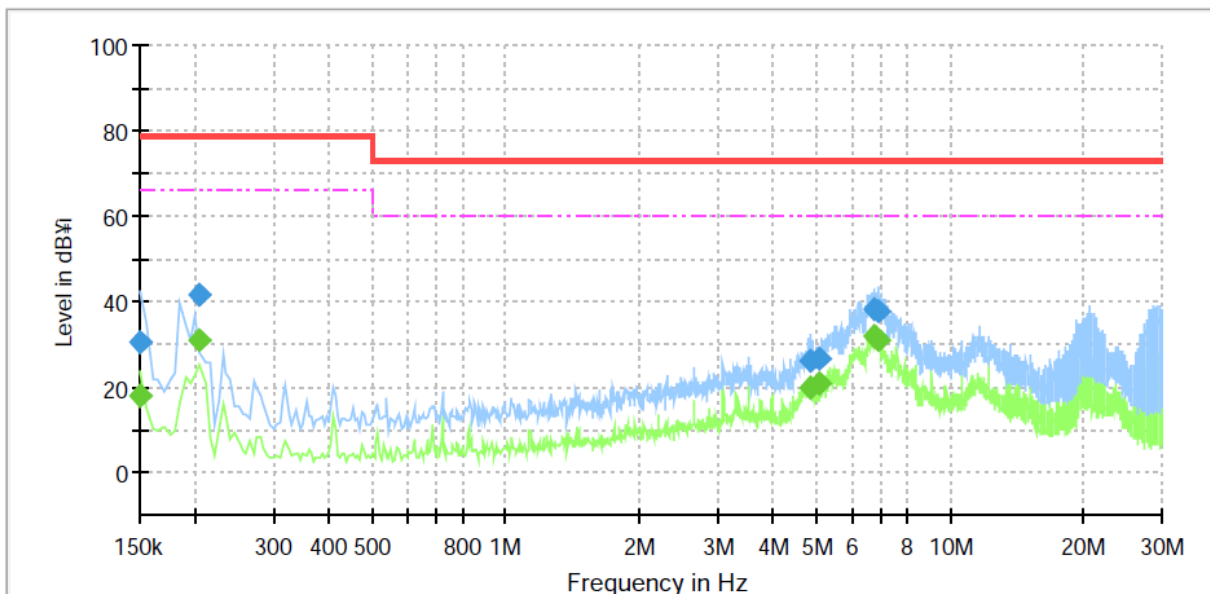

Final Result

Frequency (MHz)	QuasiPeak (dBµV)	CAverage (dBµV)	Limit (dBµV)	Margin (dB)	Meas. Time (ms)	Bandwidth (kHz)	Line	Corr. (dB)
0.150000	---	17.87	66.00	48.13	1000.0	9.000	L1	19.5
0.150000	30.37	---	79.00	48.63	1000.0	9.000	L1	19.5
0.205000	---	31.02	66.00	34.98	1000.0	9.000	L1	19.5
0.205000	41.60	---	79.00	37.40	1000.0	9.000	L1	19.5
4.840000	---	20.13	60.00	39.87	1000.0	9.000	L1	19.7
4.840000	25.96	---	73.00	47.04	1000.0	9.000	L1	19.7
5.070000	---	21.11	60.00	38.89	1000.0	9.000	L1	19.6
5.070000	26.44	---	73.00	46.56	1000.0	9.000	L1	19.6
6.740000	---	32.04	60.00	27.96	1000.0	9.000	L1	19.9
6.740000	38.31	---	73.00	34.69	1000.0	9.000	L1	19.9
6.910000	---	31.23	60.00	28.77	1000.0	9.000	L1	19.9
6.910000	37.69	---	73.00	35.31	1000.0	9.000	L1	19.9

This report shall not be reproduced except in full, without the written approval of KES Co., Ltd.
 The results shown in this test report refer only to the sample(s) tested unless otherwise stated.
 The authenticity of the test report, contact shchoi@kes.co.kr

NEUTRAL LINE

Common Information

Test Description: Conducted Emission
 Model No.: HRX-1621P
 Phase:
 Mode: N
 Operator Name: KES

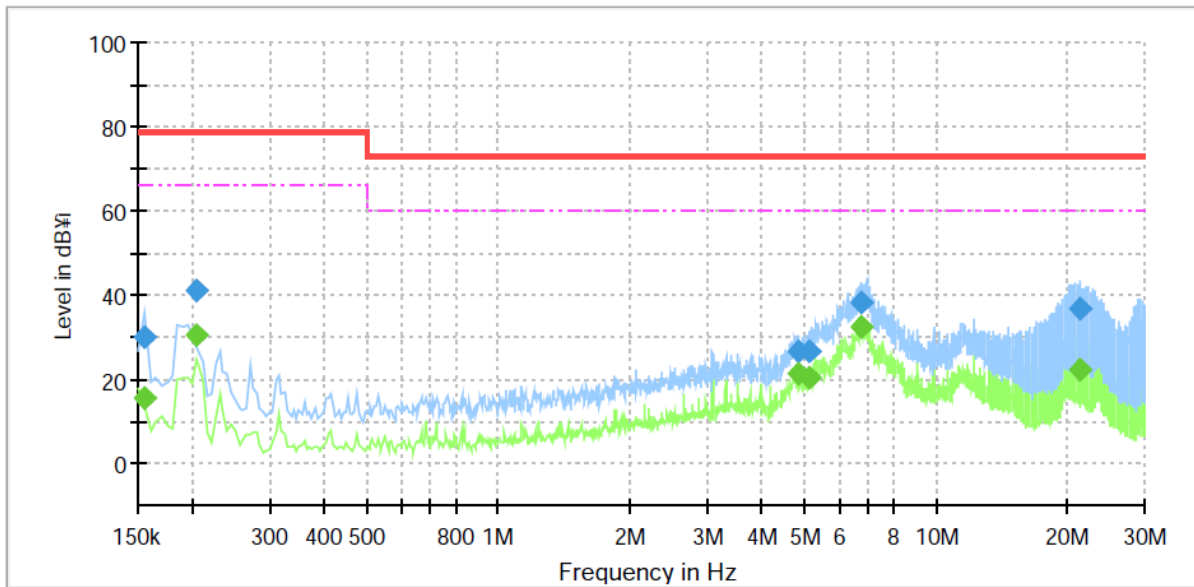

Final Result

Frequency (MHz)	QuasiPeak (dBµV)	CAverage (dBµV)	Limit (dBµV)	Margin (dB)	Meas. Time (ms)	Bandwidth (kHz)	Line	Corr. (dB)
0.155000	---	15.77	66.00	50.23	1000.0	9.000	N	19.5
0.155000	30.05	---	79.00	48.95	1000.0	9.000	N	19.5
0.205000	---	30.43	66.00	35.57	1000.0	9.000	N	19.5
0.205000	41.32	---	79.00	37.68	1000.0	9.000	N	19.5
4.850000	---	21.28	60.00	38.72	1000.0	9.000	N	19.7
4.850000	26.71	---	73.00	46.29	1000.0	9.000	N	19.7
5.125000	---	20.27	60.00	39.73	1000.0	9.000	N	19.7
5.125000	26.60	---	73.00	46.40	1000.0	9.000	N	19.7
6.720000	---	32.34	60.00	27.66	1000.0	9.000	N	19.9
6.720000	38.37	---	73.00	34.63	1000.0	9.000	N	19.9
21.405000	---	22.35	60.00	37.65	1000.0	9.000	N	20.5
21.405000	37.03	---	73.00	35.97	1000.0	9.000	N	20.5

◆ Calculation

QuasiPeak [dBµV] / CAverage [dBµV] = Reading Value [dBµV] + Corr. [dB]

QuasiPeak / CAverage : The Final Value

Reading Value : Not shown in the table.

Corr. : Correction values (LISN FACTOR + (Cable Loss + Pulse Limiter FACTOR))

This report shall not be reproduced except in full, without the written approval of KES Co., Ltd.
 The results shown in this test report refer only to the sample(s) tested unless otherwise stated.
 The authenticity of the test report, contact shchoi@kes.co.kr

Conducted Emissions at Telecommunication Ports

[10 Mbps]

Common Information

Test Description:	Telecommunication Emission
Model No.:	HRX-1621P
Mode :	
Speed :	10 Mbps
Operator Name:	KES

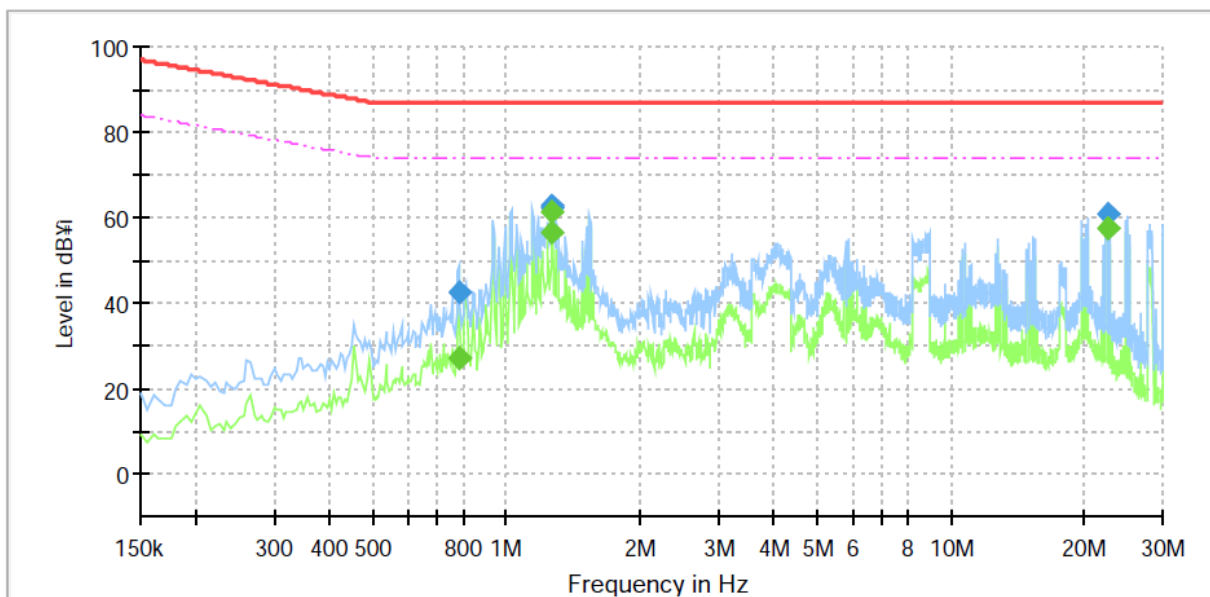

Final Result

Frequency (MHz)	QuasiPeak (dBµV)	CAverage (dBµV)	Limit (dBµV)	Margin (dB)	Meas. Time (ms)	Bandwidth (kHz)	Line	Corr. (dB)
0.780000	---	27.21	74.00	46.79	1000.0	9.000	Single Line	20.3
0.780000	42.58	---	87.00	44.42	1000.0	9.000	Single Line	20.3
1.265000	---	61.43	74.00	12.57	1000.0	9.000	Single Line	20.4
1.265000	63.02	---	87.00	23.98	1000.0	9.000	Single Line	20.4
1.270000	---	56.74	74.00	17.26	1000.0	9.000	Single Line	20.4
1.270000	62.55	---	87.00	24.45	1000.0	9.000	Single Line	20.4
22.455000	---	57.50	74.00	16.50	1000.0	9.000	Single Line	20.7
22.455000	60.81	---	87.00	26.19	1000.0	9.000	Single Line	20.7

This report shall not be reproduced except in full, without the written approval of KES Co., Ltd.
The results shown in this test report refer only to the sample(s) tested unless otherwise stated.
The authenticity of the test report, contact shchoi@kes.co.kr

[100 Mbps]

Common Information

Test Description:	Telecommunication Emission
Model No.:	HRX-1621P
Mode :	
Speed :	100 Mbps
Operator Name:	KES

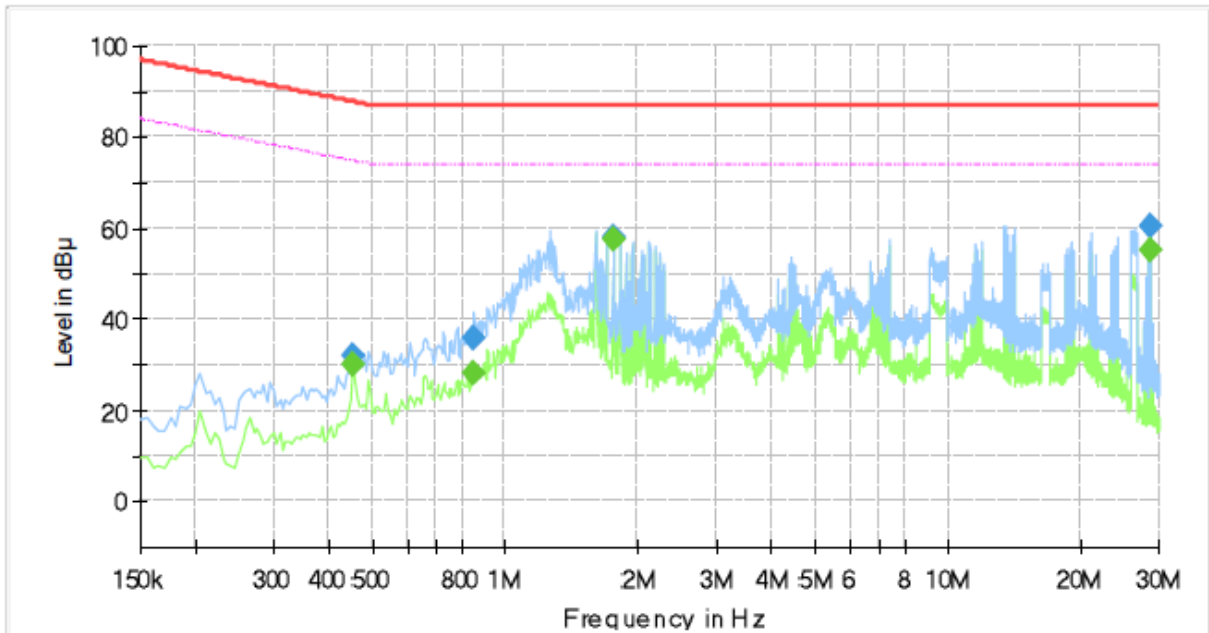

Final Result

Frequency (MHz)	QuasiPeak (dBμV)	CAverage (dBμV)	Limit (dBμV)	Margin (dB)	Meas. Time (ms)	Bandwidth (kHz)	Line	Corr. (dB)
0.455000	---	31.05	74.78	43.73	1000.0	9.000	Single Line	20.0
0.455000	34.18	---	87.78	53.60	1000.0	9.000	Single Line	20.0
0.850000	---	28.00	74.00	46.00	1000.0	9.000	Single Line	20.3
0.850000	35.13	---	87.00	51.87	1000.0	9.000	Single Line	20.3
1.755000	---	57.24	74.00	16.76	1000.0	9.000	Single Line	20.5
1.755000	56.91	---	87.00	28.09	1000.0	9.000	Single Line	20.5
28.685000	---	55.01	74.00	18.99	1000.0	9.000	Single Line	21.1
28.685000	60.56	---	87.00	26.44	1000.0	9.000	Single Line	21.1

This report shall not be reproduced except in full, without the written approval of KES Co., Ltd.
The results shown in this test report refer only to the sample(s) tested unless otherwise stated.
The authenticity of the test report, contact shchoi@kes.co.kr

[1 000 Mbps]

Common Information

Test Description:	Telecommunication Emission
Model No.:	HRX-1621P
Mode :	
Speed :	1 000 Mbps
Operator Name:	KES

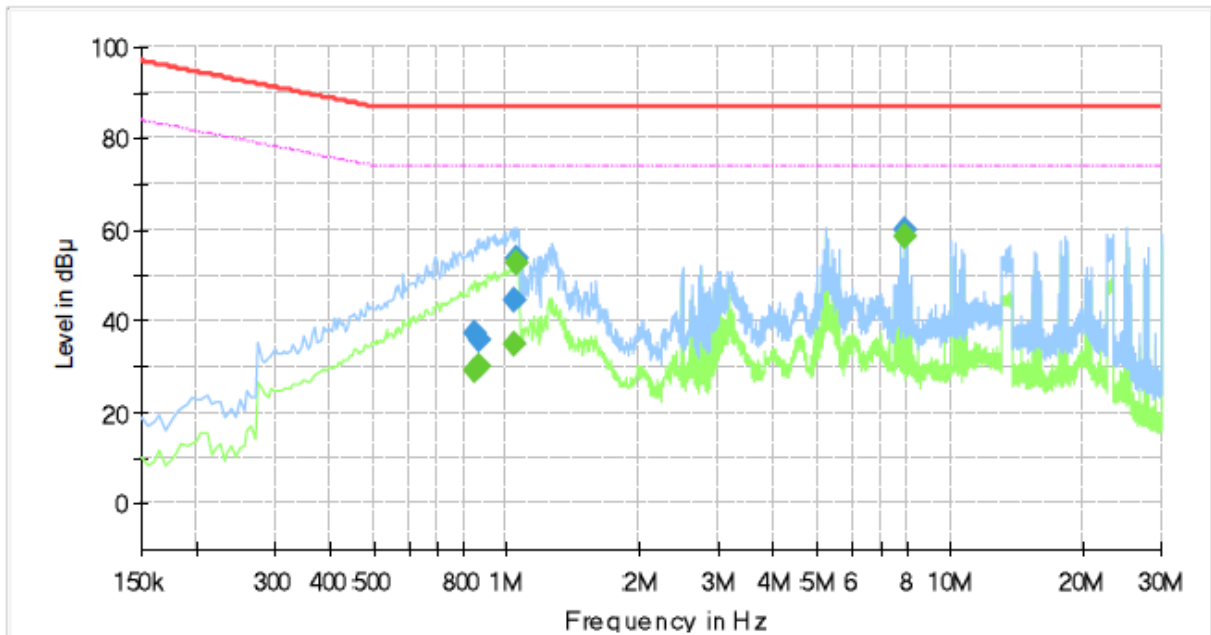

Final Result

Frequency (MHz)	QuasiPeak (dBμV)	CAverage (dBμV)	Limit (dBμV)	Margin (dB)	Meas. Time (ms)	Bandwidth (kHz)	Line	Corr. (dB)
0.845000	---	29.22	74.00	44.78	1000.0	9.000	Single Line	20.2
0.845000	37.17	---	87.00	49.83	1000.0	9.000	Single Line	20.2
0.865000	---	30.08	74.00	43.92	1000.0	9.000	Single Line	20.2
0.865000	35.74	---	87.00	51.26	1000.0	9.000	Single Line	20.2
1.040000	---	35.10	74.00	38.90	1000.0	9.000	Single Line	20.3
1.040000	44.36	---	87.00	42.64	1000.0	9.000	Single Line	20.3
1.050000	---	52.51	74.00	21.49	1000.0	9.000	Single Line	20.3
1.050000	53.56	---	87.00	33.44	1000.0	9.000	Single Line	20.3
7.925000	---	58.28	74.00	15.72	1000.0	9.000	Single Line	19.9
7.925000	59.86	---	87.00	27.14	1000.0	9.000	Single Line	19.9

◆ Calculation

QuasiPeak[dBuV] / CAverage [dBuV] = Reading Value[dBuV] + Corr. [dB]

QuasiPeak / CAverage : The Final Value

Reading Value : Not shown in the table.

Corr. : Correction values (ISN FACTOR + (Cable Loss + Pulse Limiter FACTOR))

This report shall not be reproduced except in full, without the written approval of KES Co., Ltd.
The results shown in this test report refer only to the sample(s) tested unless otherwise stated.
The authenticity of the test report, contact shchoi@kes.co.kr

Radiated Electric Field Emissions(Below 1 GHz)

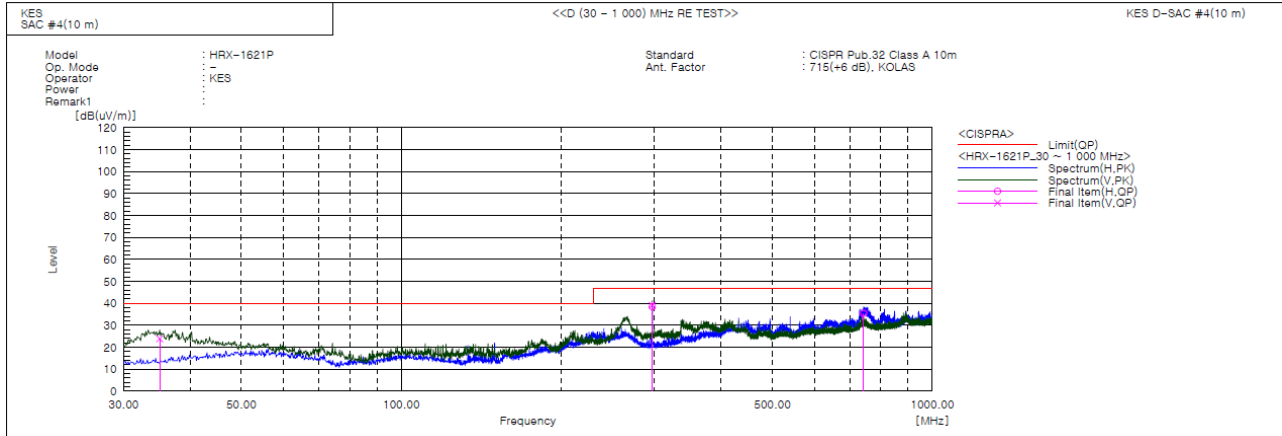

Final Result

No.	Frequency [MHz]	(P)	Reading QP [dB(uV)]	c.f [dB(1/m)]	Result QP [dB(uV/m)]	Limit QP [dB(uV/m)]	Margin QP [dB]	Height [cm]	Angle [deg]	Remark
1	35.093	V	48.8	-24.9	23.9	40.0	16.1	105.0	341.0	
2	296.986	V	57.9	-18.7	39.2	47.0	7.8	135.0	333.0	
3	296.996	H	57.2	-18.7	38.5	47.0	8.5	320.0	186.0	
4	742.465	H	42.9	-7.4	35.5	47.0	11.5	400.0	332.0	

◆ Calculation

Result(QP) [dB(μV/m)] = (Reading(QP)[dB(μV)] + c.f[dB(1/m)])

Margin(OP)[dB] = Limit[dB(μV/m)] - Result(OP) [dB(μV/m)]

Reading(QP) : Reading value, Result(QP) : Reading value + Factor value

Limit(OP) : Limit value, c.f : (ANT Factor + Cable Loss - Preamp Factor), Margin: Margin value

This report shall not be reproduced except in full, without the written approval of KES Co., Ltd.
The results shown in this test report refer only to the sample(s) tested unless otherwise stated.
The authenticity of the test report, contact shchoi@kes.co.kr



Radiated Electric Field Emissions(Above 1 GHz)

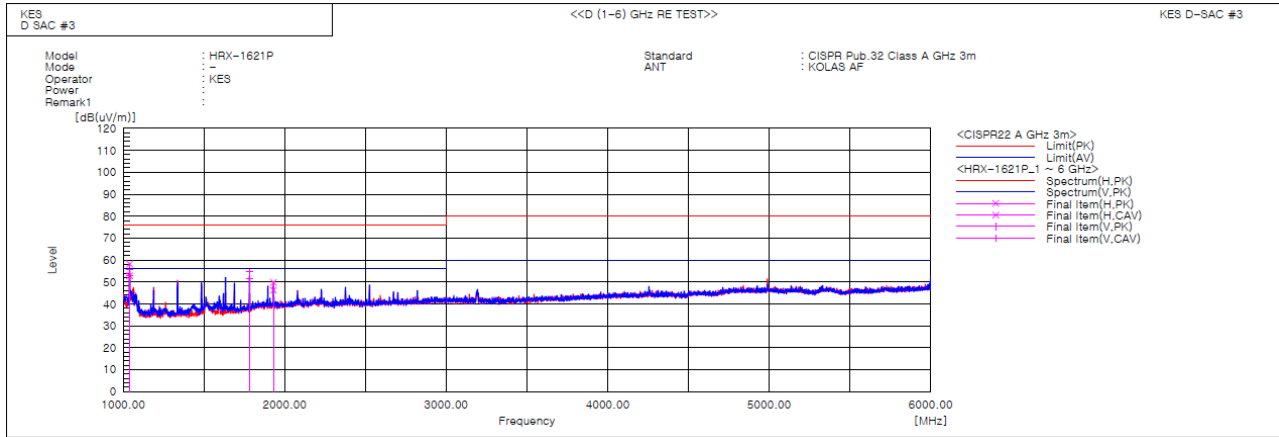

Final Result

No.	Frequency [MHz]	(P)	Reading PK [dB(uV)]	Reading CAV [dB(uV)]	c.f [dB(1/m)]	Result PK [dB(uV/m)]	Result CAV [dB(uV/m)]	Limit PK [dB(uV/m)]	Limit AV [dB(uV/m)]	Margin PK [dB]	Margin CAV [dB]	Height [cm]	Angle [deg]	Remark
1	1039.460	H	67.5	62.1	-9.3	58.2	52.8	76.0	56.0	17.8	3.2	100.0	348.0	
2	1930.290	H	52.1	48.5	-2.3	49.8	46.2	76.0	56.0	26.2	9.8	100.0	69.3	
3	1039.550	V	64.9	62.0	-9.3	55.6	52.7	76.0	56.0	20.4	3.3	100.0	358.0	
4	1781.890	V	58.3	55.0	-3.6	54.7	51.4	76.0	56.0	21.3	4.6	100.0	351.4	

◆ Calculation

$$\text{Result(PK/CAV)} [\text{dB}(\mu\text{V}/\text{m})] = (\text{Reading(PK/CAV)} [\text{dB}(\mu\text{V})] + \text{c.f} [\text{dB}(1/\text{m})])$$

$$\text{Margin(PK/CAV)} [\text{dB}] = \text{Limit} [\text{dB}(\mu\text{V}/\text{m})] - \text{Result(PK/CAV)} [\text{dB}(\mu\text{V}/\text{m})]$$

Reading(PK/CAV) : Reading value, Result(PK/CAV) : Reading value + Factor value

Limit(QP) : Limit value, c.f : (ANT Factor + Cable Loss - Preamp Factor), Margin: Margin value

This report shall not be reproduced except in full, without the written approval of KES Co., Ltd.
 The results shown in this test report refer only to the sample(s) tested unless otherwise stated.
 The authenticity of the test report, contact shchoi@kes.co.kr

Test Setup Photos and Configuration

Conducted Voltage Emissions



This report shall not be reproduced except in full, without the written approval of KES Co., Ltd.
The results shown in this test report refer only to the sample(s) tested unless otherwise stated.
The authenticity of the test report, contact shchoi@kes.co.kr

Conducted Telecommunication Emissions



This report shall not be reproduced except in full, without the written approval of KES Co., Ltd.
The results shown in this test report refer only to the sample(s) tested unless otherwise stated.
The authenticity of the test report, contact shchoi@kes.co.kr

Radiated Electric Field Emissions(Below 1 GHz)

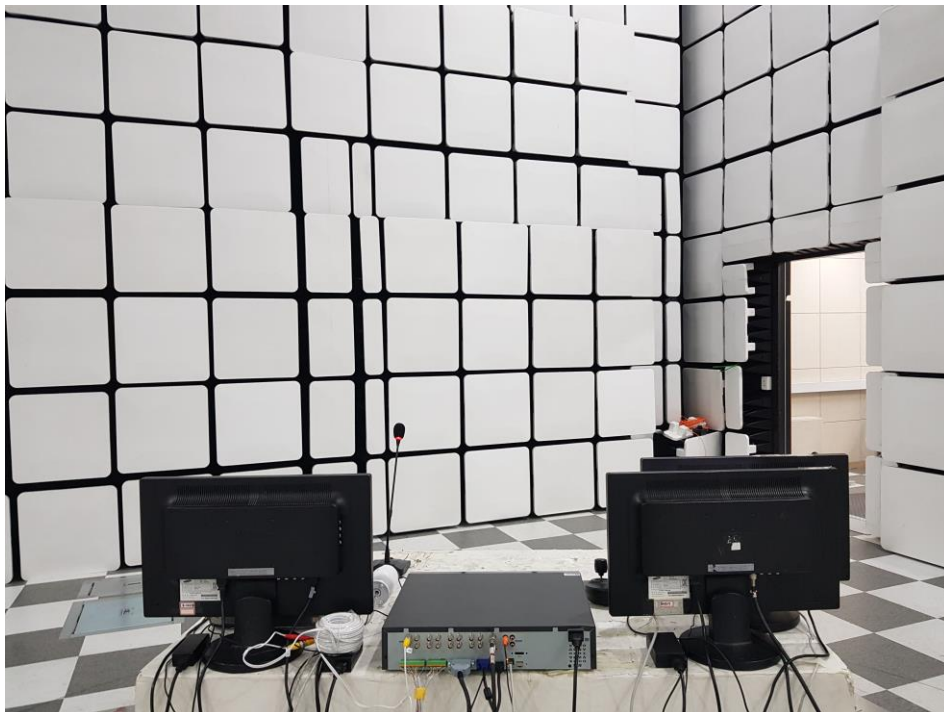
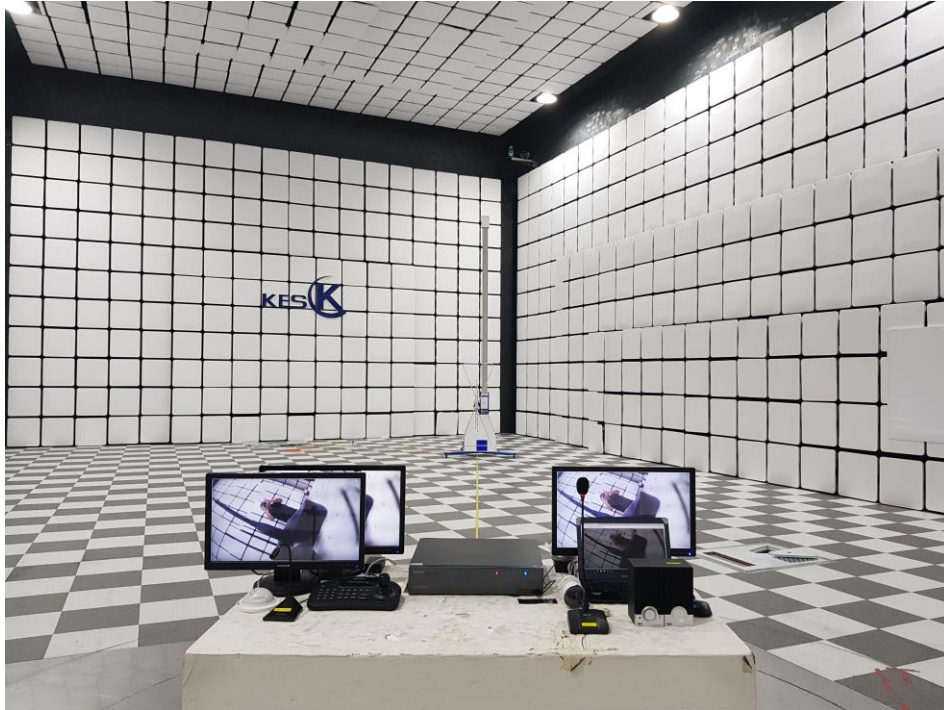

This report shall not be reproduced except in full, without the written approval of KES Co., Ltd.
The results shown in this test report refer only to the sample(s) tested unless otherwise stated.
The authenticity of the test report, contact shchoi@kes.co.kr

Radiated Electric Field Emissions(Above 1 GHz)

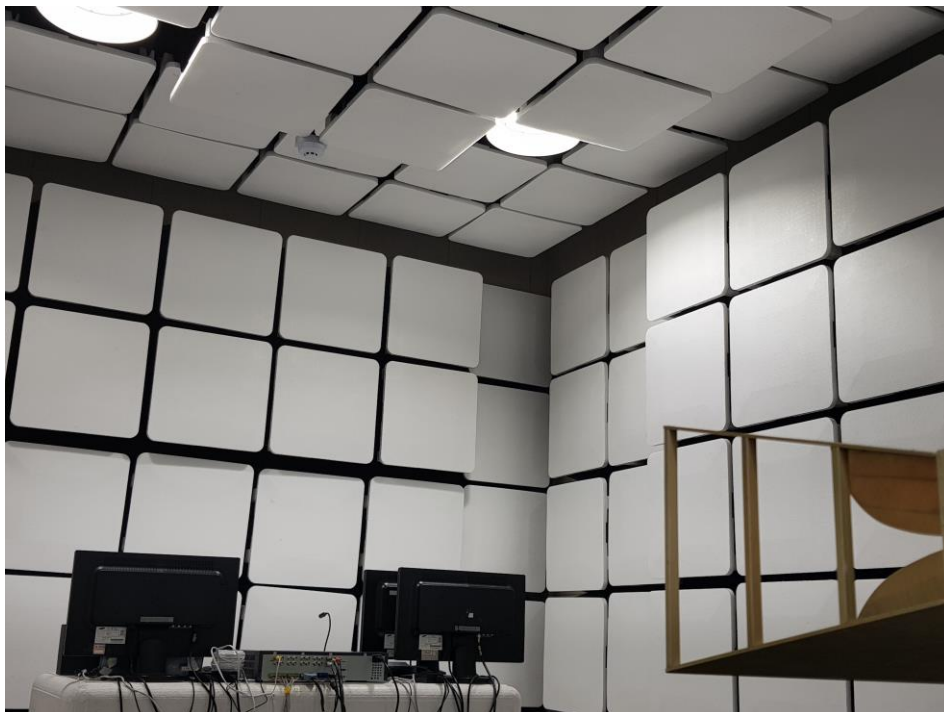

This report shall not be reproduced except in full, without the written approval of KES Co., Ltd.
The results shown in this test report refer only to the sample(s) tested unless otherwise stated.
The authenticity of the test report, contact shchoi@kes.co.kr

EUT External Photographs

(Top)



(Bottom)



This report shall not be reproduced except in full, without the written approval of KES Co., Ltd.
The results shown in this test report refer only to the sample(s) tested unless otherwise stated.
The authenticity of the test report, contact shchoi@kes.co.kr

EUT Internal Photographs

(Internal View)



This report shall not be reproduced except in full, without the written approval of KES Co., Ltd.
The results shown in this test report refer only to the sample(s) tested unless otherwise stated.
The authenticity of the test report, contact shchoi@kes.co.kr

EUT Internal View – Main Board

(Top)

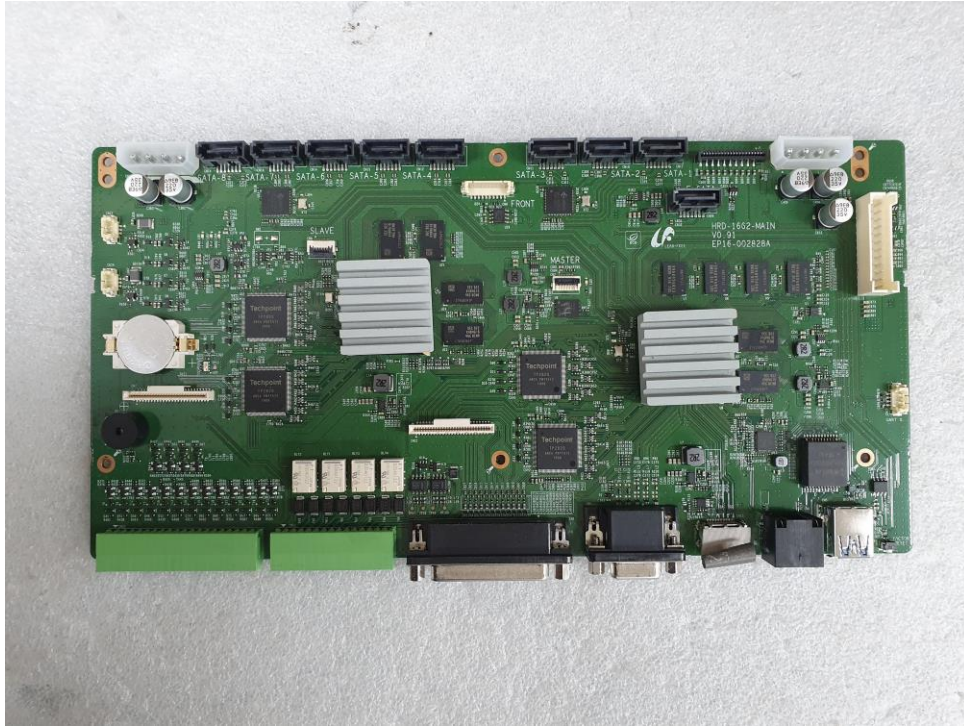

(Bottom)

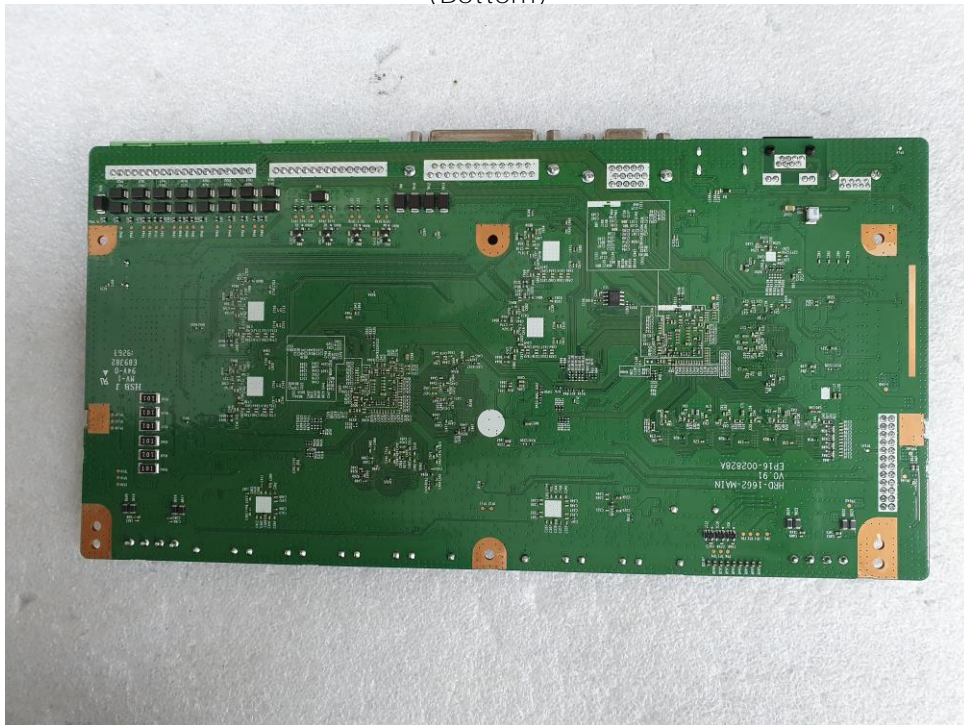

This report shall not be reproduced except in full, without the written approval of KES Co., Ltd.
The results shown in this test report refer only to the sample(s) tested unless otherwise stated.
The authenticity of the test report, contact shchoi@kes.co.kr

EUT Internal View – Sub Board 1

(Top)

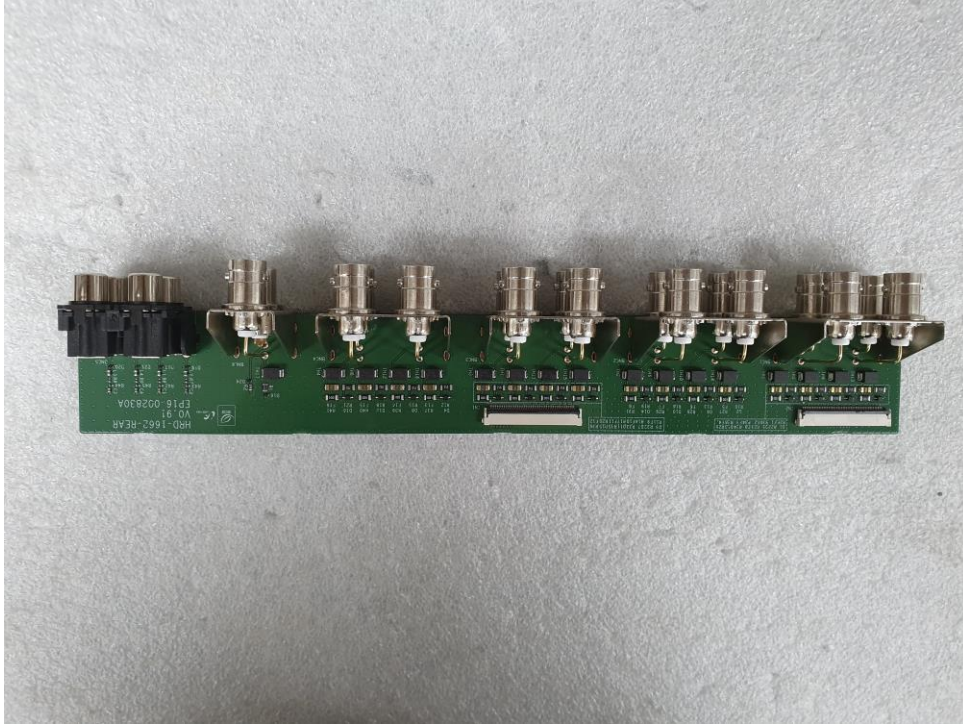

(Bottom)



This report shall not be reproduced except in full, without the written approval of KES Co., Ltd.
The results shown in this test report refer only to the sample(s) tested unless otherwise stated.
The authenticity of the test report, contact shchoi@kes.co.kr

EUT Internal View – Sub Board 2

(Top)

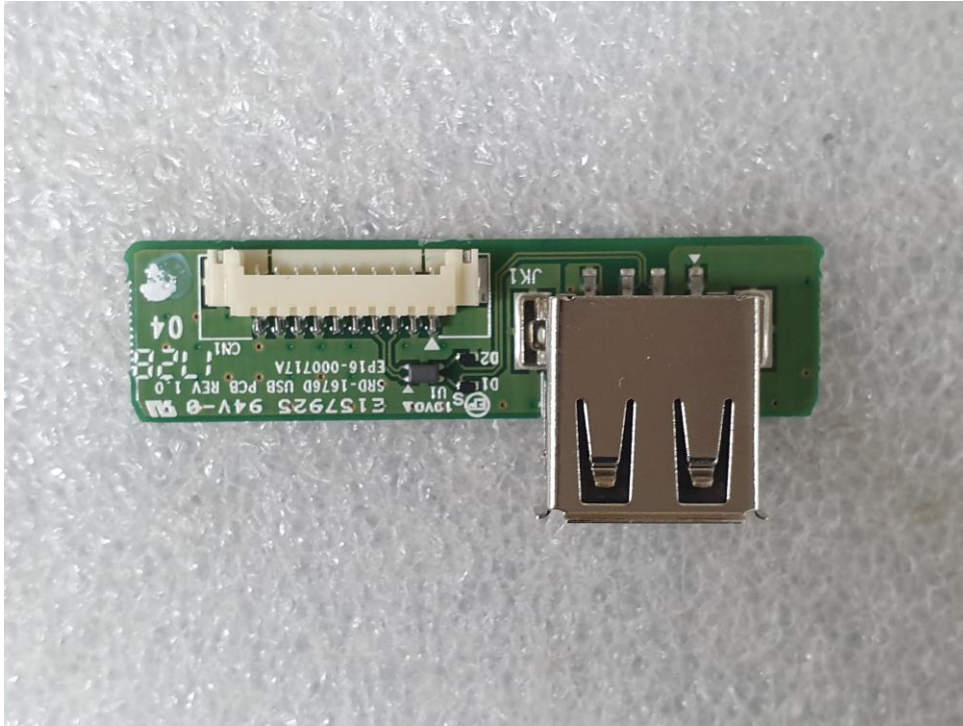

(Bottom)

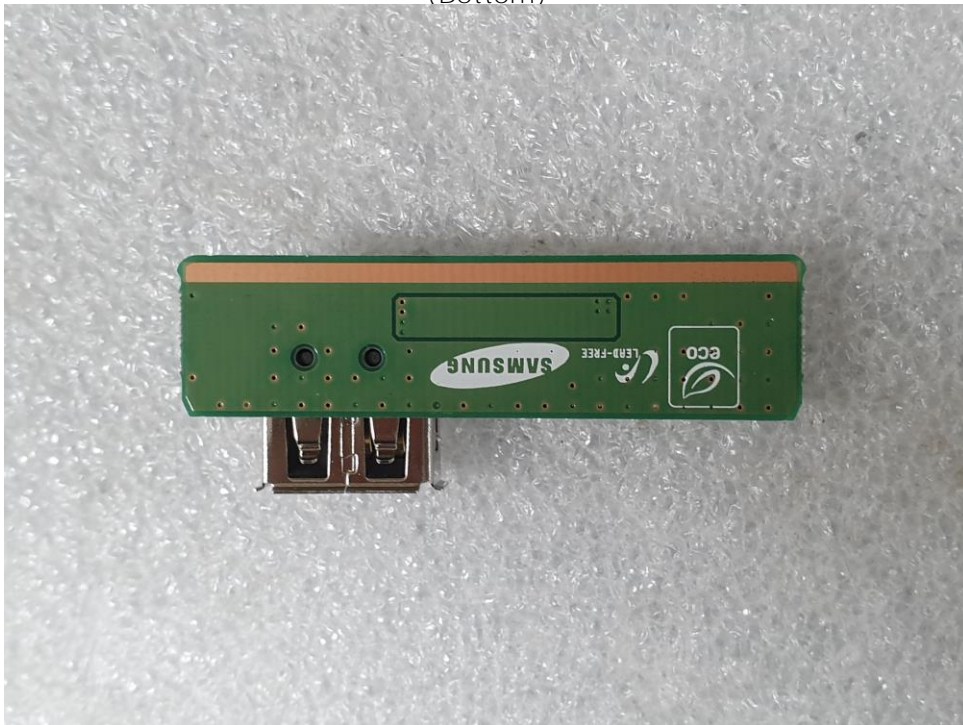

This report shall not be reproduced except in full, without the written approval of KES Co., Ltd.
The results shown in this test report refer only to the sample(s) tested unless otherwise stated.
The authenticity of the test report, contact shchoi@kes.co.kr

EUT Internal View – Sub Board 3

(Top)



This report shall not be reproduced except in full, without the written approval of KES Co., Ltd.
The results shown in this test report refer only to the sample(s) tested unless otherwise stated.
The authenticity of the test report, contact shchoi@kes.co.kr

EUT Internal View – HDD

(Top)



(Bottom)

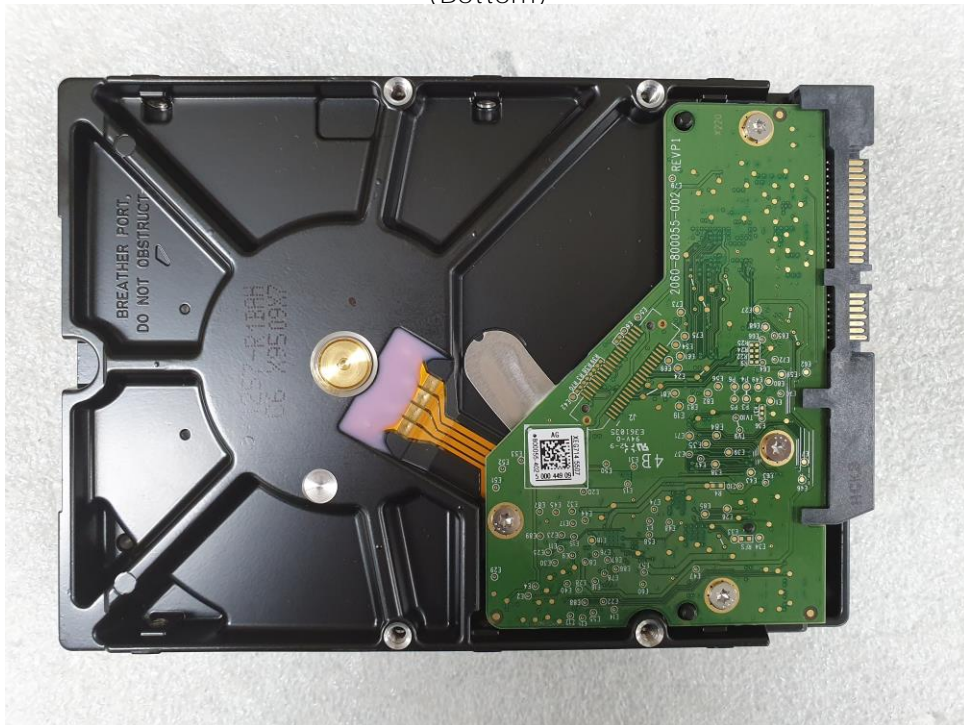

This report shall not be reproduced except in full, without the written approval of KES Co., Ltd.
The results shown in this test report refer only to the sample(s) tested unless otherwise stated.
The authenticity of the test report, contact shchoi@kes.co.kr

EUT Internal View – SMPS

(Top)



(Bottom)



This report shall not be reproduced except in full, without the written approval of KES Co., Ltd.
The results shown in this test report refer only to the sample(s) tested unless otherwise stated.
The authenticity of the test report, contact shchoi@kes.co.kr