



EMC TEST REPORT For CE

Test Report No. : KES-E1-19T0459
Date of Issue : Aug. 13, 2019
Product name : Pentabrid DVR (Digital Video Recorder)
Model/Type No. : HRX-420P
Variant Model : -
Applicant : Hanwha Techwin Co., Ltd.
Applicant Address : 6, Pangyo-ro 319 Beon-gil, Bundang-gu, Seongnam-si,
Gyeonggi-do, 13488, KOREA
Manufacturer : 1. HANWHA TECHWIN(TIANJIN) CO., LTD
2. HANWHA TECHWIN SECURITY VIETNAM CO.,LTD.
3. D-TECH CO.,LTD.
Manufacturer Address : 1. No.11 Weiliu Rd, Micro-Electronic Industrial Park, TEDA, Tianjin,
300385, People's Republic of China
2. Lot O-2, Que Vo Industrial Zone extended area,
Nam Son commune, Bac Ninh city, Bac Ninh province, Vietnam
3. 173-25, Saneop-ro, Gwonseon-gu, Suwon-si, Gyeonggi- do,
Korea (Suwon Industrial Complex)
Date of Receipt : Jul. 25, 2019
Test date : Aug. 06, 2019 ~ Aug. 11, 2019
Test Results : **In Compliance** **Not in Compliance**

Tested by

Min Seong, Kim
EMC Test Engineer

Reviewed by

Dong-Hun, Jang
EMC Technical Manager

This test report is not related to KS Q ISO/IEC 17025 and KOLAS.

This report shall not be reproduced except in full, without the written approval of KES Co., Ltd.
The results shown in this test report refer only to the sample(s) tested unless otherwise stated.
The authenticity of the test report, contact shchoi@kes.co.kr



KES Co., Ltd.

3701, 40, Simin-daero 365beon-gil,
Dongan-gu, Anyang-si, Gyeonggi-do, 14057, Korea
Tel: +82-31-425-6200 / Fax: +82-31-424-0450
www.kes.co.kr

Report No.:
KES-E1-19T0459
Page (2) of (59)

REPORT REVISION HISTORY

Date	Test Report No.	Revision History
Aug. 13, 2019	KES-E1-19T0459	Issued

This report shall not be reproduced except in full, without the written approval of KES Co., Ltd. This document may be altered or revised by KES Co., Ltd. personnel only, and shall be noted in the revision section of the document. Any alteration of this document not carried out by KES Co., Ltd. will constitute fraud and shall nullify the document.

This report shall not be reproduced except in full, without the written approval of KES Co., Ltd.
The results shown in this test report refer only to the sample(s) tested unless otherwise stated.
The authenticity of the test report, contact shchoi@kes.co.kr



TABLE OF CONTENTS

1.0	General Product Description	4
1.1	Test Voltage & Frequency	7
1.2	Variant Model Differences.....	7
1.3	Device Modifications.....	7
1.4	Equipment Under Test.....	7
1.5	Support Equipments.....	8
1.6	External I/O Cabling.....	9
1.7	EUT Operating Mode(s).....	9
1.8	Configuration.....	10
1.9	Remarks when standards applied	11
1.10	Calibration Details of Equipment Used for Measurement.....	11
1.11	Test Facility	11
1.12	Laboratory Accreditations and Listings	11
2.0	Test Regulations.....	12
2.1	Conducted Emissions at Mains Power Ports.....	14
2.2	Conducted Emissions at Telecommunication Ports	15
2.3	Radiated Electric Field Emissions(Below 1 GHz)	16
2.4	Radiated Electric Field Emissions(Above 1 GHz).....	17
2.5	Harmonic Current Emissions.....	18
2.6	Voltage Fluctuations and Flicker	19
3.0	Criteria for compliance.....	20
3.1	Electrostatic Discharge.....	22
3.2	Radiated Electric Field Immunity	26
3.3	Electrical Fast Transients/Bursts	29
3.4	Surge Transients.....	31
3.5	Conducted Disturbance	34
3.6	Voltage Dips and Short Interruptions	36
APPENDIX A – TEST DATA.....		38
Conducted Emissions at Mains Power Ports.....		38
Conducted Emissions at Telecommunication Ports		40
Radiated Electric Field Emissions(Below 1 GHz)		41
Radiated Electric Field Emissions(Above 1 GHz).....		42
Harmonic Current Emissions and Voltage Fluctuations and Flicker		43
Test Setup Photos and Configuration		46
Conducted Voltage Emissions		46
Conducted Telecommunication Emissions		47
Radiated Electric Field Emissions(Below 1 GHz)		48
Radiated Electric Field Emissions(Above 1 GHz).....		49
Harmonic Current Emissions and Voltage Fluctuations and Flicker		50
Electrostatic Discharge		51
Radiated Electric Field Immunity		51
Electrical Fast Transients/Bursts.....		52
Surge Transients.....		52
Conducted Disturbance.....		53
Voltage Dips and Short Interruptions.....		53
EUT External Photographs.....		54
EUT Internal Photographs		55

This report shall not be reproduced except in full, without the written approval of KES Co., Ltd.
The results shown in this test report refer only to the sample(s) tested unless otherwise stated.
The authenticity of the test report, contact shchoi@kes.co.kr



1.0 General Product Description

Main Specifications of EUT are:

Video			
Video Input	Analog Camera	Input	16CH, 1Vp-p 75ohm, BNC
		Signal Type	AHD(8MP, 5MP, 4MP, 1080p, 720p) HDTVI(8MP, 5MP, 4MP, 1080p, 720p) HDCVI(5MP, 4MP, 1080p, 720p) CVBS (NTSC/PAL) ※8MP only supported on #1 channel
	Network Camera	Input	2CH (up to 6CH)
		Resolution	CIF ~ 8MP
		Protocols	SUNAPI(Wisenet), ONVIF
Live	Local Display		1x HDMI, 1x VGA
Operating System	Embedded		Linux
Recording	Compression		H.265, H.264, MJPEG
	Record Rate(Analog)		- Analog Camera(NTSC/PAL) (Main Stream) 8MP 8/8fps CH, 5M 12/12fps CH, 4M 15/12fps CH, 2M 30/25fps CH, 720p 30/25fps/CH, SD 30/25fps/CH (Sub Stream) HD: 640x360 full fps/CH, SD: upto SD full fps/CH *The maximum recording frame rate depends on the frame rate of the input camera.
	Mode		Manual, Schedule (Continuous/Event), Event(Pre/Post), Dual Track
	Event Trigger		Alarm Input Analog Camera Video Loss, Motion Detection, Tampering Network Camera Camera Event (Sensor, MD, Video analytics), VA event (Tampering, Enter / Exit, Passing, Virtual- line, (Dis)Appear, Face Detection, Audio detection), Defocus camera event
	Event Action		E-mail, PTZ preset, Alarm out, Buzzer, Monitor out
	Overwrite modes		Overwrite On/Off

This report shall not be reproduced except in full, without the written approval of KES Co., Ltd.
The results shown in this test report refer only to the sample(s) tested unless otherwise stated.
The authenticity of the test report, contact shchoi@kes.co.kr



KES Co., Ltd.

3701, 40, Simin-daero 365beon-gil,
Dongan-gu, Anyang-si, Gyeonggi-do, 14057, Korea
Tel: +82-31-425-6200 / Fax: +82-31-424-0450
www.kes.co.kr

Report No.:
KES-E1-19T0459
Page (5) of (59)

Search & Playback	Performance		Max. 4 users (Set 1, Remote 3)
	Resolution		CIF ~ 8MP
	Playback Control		Fast Forward/Backward (x2,x4,x8,x16,x32,x64, x128, x256) Slow Forward/Backward (x1/2,x1/4,x1/8) ※Move one step up/down
	Internal		Up to 1 SATA HDDs Max. 6TB/HDD(TBD)
Storage	External		USB(for Backup)
	File Format		BU(DVR Player), SEC(Set, Include Player), AVI(Webviewer only)
NETWORK			
Protocol support			TCP/IP, UDP/IP, RTP (UDP), RTP (TCP), RTSP, NTP, HTTP, DHCP (Server, Client), PPPoE, SMTP, ICMP, IGMP, ARP, DNS, DDNS, uPnP, HTTPS, SNMP, ONVIF (Profile-S), SUNAPI(Server, Client)
Max. Remote users			Search (3), Live Unicast (10), Multicast (20)
Security			IPv4/v6
Security			IP address filtering, User access log, 802.1x Authentication, Encryption (ID/PW, Recording, Transmission, Backup)
OS			Supported OS : Window XP (Service pack 2 or above), Vista, 7, 8, 10, Mac OS X (10.7 or above)
Web Browser			Google Chrome 47 or above, MS Edge 20 or above, Safari 9 or above *support Plug-in free Web
Viewer Software			SSM, Webviewer, SmartViewer, Wisenet Mobile Viewer
CMS Support			SDK/CGI(SUNAPI)
Function			
Easy Configuration			Setup Wizard (Language Date/Time, Password, Network, Auto Camera Configuration), P2P (QR code)
ARB (Auto Recovery Backup)			support
PTZ	Control/Preset		Via GUI & RS-485, Webviewer, SPC-7000 / 300 presets
Smart phone	OS / Protocol support		Android , iOS, RTP, RTSP, HTTP, CGI(SUNAPI)
	Control		Live(4ch) : Multi-Profile Support Playback(1ch, Max. 2MP) Event push
System Control			Mouse, IR Remocon, Web, SPC-7000

This report shall not be reproduced except in full, without the written approval of KES Co., Ltd.
The results shown in this test report refer only to the sample(s) tested unless otherwise stated.
The authenticity of the test report, contact shchoi@kes.co.kr



KES Co., Ltd.

3701, 40, Simin-daero 365beon-gil,
 Dongan-gu, Anyang-si, Gyeonggi-do, 14057, Korea
 Tel: +82-31-425-6200 / Fax: +82-31-424-0450
 www.kes.co.kr

Report No.:
 KES-E1-19T0459
 Page (6) of (59)

INDICATOR / INTERFACE		
Front	Indicator	Power status LED 1ea, Record status LED 1ea, Network Action LED 1ea
Monitors	Mode	
	HDMI	1 HDMI (4K(3840 x 2160), 2K(2560 x 1440), 1920x1080, 1280x1024, 1280x720)
	VGA	1 VGA (1920x1080, 1280x1024, 1280x720)
	Composite(Spot)	BNC(1CH) ※ Included OSD On Screen, Single, Multi, Auto Change mode Support
Audio	Inputs/Output	1CH line in / 1CH line out
	Compression	G.711
	Sampling rate	8KHz
Alarm	Inputs/Outputs	Terminal 4 Inputs (NO/NC) / Terminal 1 relay Outputs (NO/NC) MAX DC18V, 2A, Typical DC12V, 2A
Ethernet		1 RJ45 10/100/1000 Base-T
USB		2 ports(USB 2.0, Front/Rear)
Serial		RS-485(Full Duplex) for PTZ, Samsung System Keyboard
Coaxia Control		Support (CVBS and AHD/CVI/TVI)
Reset		Yes(Factory Reset, Alarm Reset)
General		
Electrical	Input Voltage/Current	DC12V Adaptor(100~250V AC ±10% , 50/60Hz)
	Power consumption	(TBD) Max. W
Environmental	Operating Temperature/Humidity	+0°C to +40°C (+32°F to +104°F) / 20% to 85% RH
Mechanical	Color / Material	Black / Metal
	Dimension (W x H x D)	(TBD)W300 x H 48 x D 208.7 (11.81" x 1.89" x 8.22")
	Weight (with hard disks)	TBD kg

This report shall not be reproduced except in full, without the written approval of KES Co., Ltd.
 The results shown in this test report refer only to the sample(s) tested unless otherwise stated.
 The authenticity of the test report, contact shchoi@kes.co.kr



1.1 Test Voltage & Frequency

Unless indicated otherwise on the individual data sheet or test results, the test voltage and frequency was as indicated below.

Voltage 230Vac 100 Vac 24 Vac 12 Vdc PoE

Frequency 50 Hz 60 Hz Hz

1.2 Variant Model Differences

Not applicable

1.3 Device Modifications

Not applicable

1.4 Equipment Under Test

Description	Model Number	Serial Number	Manufacturer	Remarks
Pentabrid DVR (Digital Video Recorder)	HRX-420P	-	HANWHA TECHWIN (TIANJIN) CO., LTD	EUT
AC / DC Adapter	KPL-048F-VI	-	Channel Well Technology (Guangzhou) Co.,Ltd.	-
Mouse	MOKJUO	-	Primax Electronics Ltd.	-
HDD	WD40PUEX- 64N96Y0	-	Western Digital	4 TB



1.5 Support Equipments

Description	Model Number	Serial Number	Manufacturer	Remarks
Camera	SDC-79446BF	-	HANWHA TECHWIN (TIANJIN) CO., LTD	-
Camera Adapter	FSP-060-DIBAN2	-	Zhonghan Electronics (Shenzhen) Co., Ltd.	-
Monitor 1	SMT-2233	ZC6U67VH500194D	Weihai Daewoo Electronics Co., Ltd.	-
Monitor 2	SMT-2232	C95V67VF900038B	Weihai Daewoo Electronics Co., Ltd.	-
Monitor 3	SMT-2232	C95V67VF900015Y	Weihai Daewoo Electronics Co., Ltd.	-
Notebook	NT730U3E	JJRE91CF200065A	Samsung Electronics	-
Notebook Adapter	PA-1600-66	AD-6019P	LITEON	-
Speaker	BR10000A CUVE	-	BEIJING EDIFIER HI-TECH GROUP.	-
MIC	CMK-303	-	CAMAC	-
Controller	SPC-1010	C50E67WG10100F	SamSung Techwin Co.,Ltd.	-
Controller Adapter	RS-AB1000	-	Dongguan Jinhuaasheng Power Technology Co.,Ltd.	-
Alarm	-	-	-	-
Button Alarm	-	-	-	-
USB Memory	-	-	SONY	16 GB

This report shall not be reproduced except in full, without the written approval of KES Co., Ltd.
The results shown in this test report refer only to the sample(s) tested unless otherwise stated.
The authenticity of the test report, contact shchoi@kes.co.kr



1.6 External I/O Cabling

Start		END		Cable Spec.	
Description	I/O Port	Description	I/O Port	Length	Shield
Pentabrid DVR (Digital Video Recorder) (EUT)	VIDEO IN	Camera	BNC	10.0	U
	HDMI	Monitor 1	HDMI	1.5	S
	VGA OUT	Monitor 2	D-SUB	1.5	S
	SPOT	Monitor 3	BNC	3.0	S
	NETWORK	Notebook	RJ-45	3.0	U
	AUDIO OUT	Speaker	RCA	1.6	U
	AUDIO IN	MIC	RCA	1.6	U
	RS-485	Controller	RS-485	10.0	U
	Alarm Out	Alarm	Alarm In	10.0	U
	Alarm In	Button Alarm	Alarm Out	10.0	U
	USB 2.0	Mouse	USB	1.3	U
	USB 3.0	USB Memory	USB	-	-

* Unshielded=U, Shielded=S

1.7 EUT Operating Mode(s)

Test Mode	operating
OP	EUT Monitoring, Ping Test

EUT Test operating S/W		
Name	Version	Manufacture Company
WebViewer	-	Hanwha Techwin Co., Ltd.

This report shall not be reproduced except in full, without the written approval of KES Co., Ltd.
 The results shown in this test report refer only to the sample(s) tested unless otherwise stated.
 The authenticity of the test report, contact shchoi@kes.co.kr

1.8 Configuration

■ AC Main
 □ DC Main

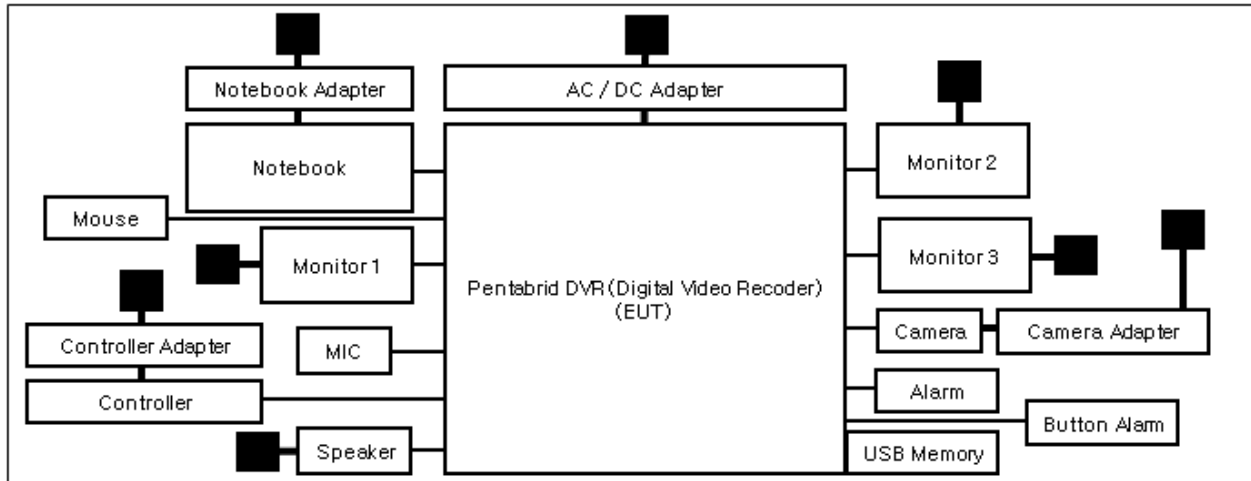

This report shall not be reproduced except in full, without the written approval of KES Co., Ltd.
 The results shown in this test report refer only to the sample(s) tested unless otherwise stated.
 The authenticity of the test report, contact shchoi@kes.co.kr

1.9 Remarks when standards applied

N/A







1.10 Calibration Details of Equipment Used for Measurement

Test equipment and test accessories are calibrated on regular basis. The maximum time between calibrations is one year or what is recommended by the manufacturer, whichever is less.

1.11 Test Facility

The measurement facility is located at 473-21 Gayeo-ro, Yeosu-si, Gyeonggi-do, 12658, Korea. The sites are constructed in conformance with the requirements of ANSI C63.4:2014 and CISPR 16-1-4:2012

1.12 Laboratory Accreditations and Listings

Country	Agency	Scope of Accreditation	Logo
KOREA	RRA	EMI (3 m & 10 m Semi-Anechoic Chamber , 10 m Open Area and conducted test site) EMS (ESD, RS, EFT/Burst, Surge, CS, Magnetic, Dips and interruptions)	 KR0100
International	KOLAS	EMI (3 m & 10 m Semi-Anechoic Chamber , and conducted test site) EMS (ESD, RS, EFT/Burst, Surge, CS, Magnetic, Dips and interruptions)	 KT489
USA	FCC	3 m & 10 m Semi-Anechoic Chamber, 10 m Open Area and Conducted test site to perform FCC Part 15/18 measurements.	 KR0100
Canada	ISED	3 m & 10 m Semi-Anechoic Chamber and Conducted test site	 23298-1
JAPAN	VCCI	Mains Ports Conducted Interference Measurement, Telecommunication Ports Conducted Disturbance Measurement and Radiation 10 meter site, Facility for measuring radiated disturbance above 1 GHz	 R-20056, C-20036, T-20040, G-20057
Europe	TÜV SÜD	EMI (3 m & 10 m Semi-Anechoic Chamber , 10 m Open Area and conducted test site) EMS (ESD, RS, EFT/Burst, Surge, CS, Magnetic, Dips and interruptions)	 CARAT 001633 0003

This report shall not be reproduced except in full, without the written approval of KES Co., Ltd.
The results shown in this test report refer only to the sample(s) tested unless otherwise stated.
The authenticity of the test report, contact shchoi@kes.co.kr

2.0 Test Regulations

The emissions tests were performed according to following regulations:

EMC – Directive 2014/30/EU

EN 61000-6-3:2011

EN 61000-6-1:2007

EN 61000-6-4:2007 +A1:2011

EN 61000-6-2:2005

EN 55011:2007 +A1:2010

Group 1

Group 2

Class A

Class B

EN 55014-1:2006 +A2:2011

EN 55014-2:1997 +A2:2008

EN 55015:2013

EN 61547:2009

EN 55032: 2012/AC:2013

Class A

Class B

EN 55024:2010 +A1:2015

EN 50130-4:2011+A1:2014

EN 61000-3-2:2014

EN 61000-3-3:2013

EN 61326-1:2013



-
- | | | |
|---|----------------------------------|----------------------------------|
| <input type="checkbox"/> VCCI-CISPR 32:2016 | <input type="checkbox"/> Class A | <input type="checkbox"/> Class B |
| <input type="checkbox"/> AS/NZS CISPR32:2015 | <input type="checkbox"/> Class A | <input type="checkbox"/> Class B |
| <input type="checkbox"/> 47 CFR Part 15, Subpart B | | |
| <input type="checkbox"/> CISPR 22:2009 +A1:2010 | <input type="checkbox"/> Class A | <input type="checkbox"/> Class B |
| <input type="checkbox"/> ANSI C63.4-2014 | | |
| <input type="checkbox"/> IC Regulation ICES-003 : 2016 | | |
| <input type="checkbox"/> CAN/CSA CISPR 22-10 | <input type="checkbox"/> Class A | <input type="checkbox"/> Class B |
| <input type="checkbox"/> ANSI C63.4-2014 | | |
| <input type="checkbox"/> RE- Directive 2014/53/EU | | |
| <input type="checkbox"/> EN 301 489-1 V1.9.2 | | |
| <input type="checkbox"/> Equipment for fixed use | | |
| <input type="checkbox"/> Equipment for vehicular use | | |
| <input type="checkbox"/> Equipment for portable use | | |
| <input type="checkbox"/> EN 301 489-3 V1.6.1 | | |
| <input type="checkbox"/> EN 301 489-17 V2.2.1 | | |
| <input type="checkbox"/> EN 60945:2002 | | |

This report shall not be reproduced except in full, without the written approval of KES Co., Ltd.
The results shown in this test report refer only to the sample(s) tested unless otherwise stated.
The authenticity of the test report, contact shchoi@kes.co.kr

2.1 Conducted Emissions at Mains Power Ports

Test Date

Aug. 06, 2019

Test Location

Electro wave Shieldroom #6

Test Equipment

Used	Description	Model Number	Manufacturer	Serial Number	Cal. Due
<input checked="" type="checkbox"/>	EMI Test S/W	EMC32	R & S	9.12.00	-
<input checked="" type="checkbox"/>	EMI TEST RECEIVER	ESR3	R & S	101781	04, 22, 2020
<input checked="" type="checkbox"/>	LISN	ENV216	R & S	101787	01, 04, 2020
<input checked="" type="checkbox"/>	LISN	ESH2-Z5	R & S	100450	04, 22, 2020
<input checked="" type="checkbox"/>	PULSE LIMITER	ESH3-Z2	R & S	101915	11, 26, 2019

Test Conditions

Temperature: 25,4 °C
Relative Humidity: 53,9 % R.H.

Frequency Range of Measurement

150 kHz to 30 MHz

Instrument Settings

IF Band Width: 9 kHz

Test Results

The requirements are:

- PASS
- NOT PASS
- NOT APPLICABLE

Remarks

See Appendix A for test data.

2.2 Conducted Emissions at Telecommunication Ports

Test Date

Aug. 06, 2019

Test Location

Electro wave Shieldroom #6

Test Equipment

Used	Description	Model Number	Manufacturer	Serial Number	Cal. Due
<input checked="" type="checkbox"/>	EMI Test S/W	EMC32	R & S	9.12.00	-
<input checked="" type="checkbox"/>	EMI TEST RECEIVER	ESR3	R & S	101781	04, 22, 2020
<input checked="" type="checkbox"/>	LISN	ENV216	R & S	101787	01, 04, 2020
<input checked="" type="checkbox"/>	LISN	ESH2-Z5	R & S	100450	04, 22, 2020
<input checked="" type="checkbox"/>	PULSE LIMITER	ESH3-Z2	R & S	101915	11, 26, 2019
<input type="checkbox"/>	8-WIRE ISN CAT3,5	ENY81	R & S	100174	01, 07, 2020
<input checked="" type="checkbox"/>	8-WIRE ISN CAT6	ENY81-CAT6	R & S	101665	01, 07, 2020

Test Conditions

Temperature: 25,4 °C
Relative Humidity: 53,9 % R.H.

Frequency Range of Measurement

150 kHz to 30 MHz

Instrument Settings

IF Band Width: 9 kHz

Test Results

The requirements are:

- PASS
- NOT PASS
- NOT APPLICABLE

Remarks

See Appendix A for test data.



2.3 Radiated Electric Field Emissions(Below 1 GHz)

Test Date

Aug. 06, 2019

Test Location

OPEN AREA TEST SITE #2 SEMI ANECHOIC CHAMBER #4(10m)

Test Equipment

Used	Description	Model Number	Manufacturer	Serial Number	Cal. Due
<input checked="" type="checkbox"/>	EMI Test S/W	EP5/RE	TOYO Corporation	6.0.0	-
<input checked="" type="checkbox"/>	EMI TEST RECEIVER	ESU26	R & S	100551	04, 09, 2020
<input checked="" type="checkbox"/>	AMPLIFIER	SCU 01	R & S	100603	11, 26, 2019
<input checked="" type="checkbox"/>	TRILOG-BROADBAND ANTENNA	VULB9163	Schwarzbeck	715	11, 29, 2020
<input checked="" type="checkbox"/>	ATTENUATOR	8491A	HP	32173	03, 11, 2020

Test Conditions

Temperature: 24,4 °C
Relative Humidity: 52,9 % R.H.

Frequency Range of Measurement

30 MHz to 1 GHz

Instrument Settings

IF Band Width: 120 kHz

Test Results

The requirements are:

- PASS
 NOT PASS
 NOT APPLICABLE

Remarks

See Appendix A for test data.

2.4 Radiated Electric Field Emissions(Above 1 GHz)

Test Date

Aug. 07, 2019

Test Location

SEMI ANECHOIC CHAMBER #3

Test Equipment

Used	Description	Model Number	Manufacturer	Serial Number	Cal. Due
<input checked="" type="checkbox"/>	EMI Test S/W	EP5/RE	TOYO Corporation	6.0.0	-
<input checked="" type="checkbox"/>	EMI TEST RECEIVER	ESR7	R & S	101190	08, 06, 2020
<input checked="" type="checkbox"/>	PREAMPLIFIER	8449B	AGILENT	3008A01967	05, 27, 2020
<input type="checkbox"/>	ATTENUATOR	8491A	HP	35496	03, 11, 2020
<input checked="" type="checkbox"/>	DOUBLE RIDGED HORN ANTENNA	SAS-571	A.H.SYSTEM,INC	781	03, 12, 2021

Test Conditions

Temperature: 24,2 °C
Relative Humidity: 54,2 % R.H.

Frequency Range of Measurement

1 GHz to 6 GHz

Instrument Settings

IF Band Width: 1 MHz

Test Results

The requirements are:

- PASS
- NOT PASS
- NOT APPLICABLE

Remarks

See Appendix A for test data.

2.5 Harmonic Current Emissions

Test Date

Aug. 06, 2019

Test Location

Electro wave Shieldroom #3

Test Equipment

Used	Description	Model Number	Manufacturer	Serial Number	Cal. Due
<input checked="" type="checkbox"/>	EMI Test S/W	net.control	EM TEST	2.1.4	-
<input checked="" type="checkbox"/>	DIGITAL POWER ANALYZER	DPA 500N	EM TEST	V1024106759	04, 09, 2020
<input checked="" type="checkbox"/>	POWER SOURCE	ACS 500N6	EM TEST	V1024106760	-

Test Conditions

Temperature: 25,1 °C
Relative Humidity: 53,2 % R.H.

Classification of Equipment for Harmonic Current Emissions

- Class A
- Class B
- Class C(Below 25 W)
- Class C(Above 25 W)
- Class D

Test Results

The requirements are:

- PASS
- NOT PASS
- NOT APPLICABLE

Remarks

See Appendix A for test data.



2.6 Voltage Fluctuations and Flicker

Test Date

Aug. 06, 2019

Test Location

Electro wave Shieldroom #3

Test Equipment

Used	Description	Model Number	Manufacturer	Serial Number	Cal. Due
<input checked="" type="checkbox"/>	EMI Test S/W	net.control	EM TEST	2.1.4	-
<input checked="" type="checkbox"/>	DIGITAL POWER ANALYZER	DPA 500N	EM TEST	V1024106759	04, 09, 2020
<input checked="" type="checkbox"/>	POWER SOURCE	ACS 500N6	EM TEST	V1024106760	-

Test Conditions

Temperature: 25,1 °C
Relative Humidity: 53,2 % R.H.

Test Results

The requirements are:

- PASS
- NOT PASS
- NOT APPLICABLE

Remarks

See Appendix A for test data.

3.0 Criteria for compliance

Criteria for compliance was based on the following guidelines:

EN 50130-4:2011+A1 :2014 Alarm systems-Part 4: Electromagnetic compatibility Product family standard: Immunity requirements for components of fire, intruder and social alarm systems

The variety and the diversity of the apparatus within the scope of this document makes it

difficult to define precise criteria for the evaluation of the immunity test results.

If as a result of the application of the tests defined in this standard, the apparatus becomes dangerous or unsafe then the apparatus shall be deemed to have failed the test.

A functional description and a definition of performance by the manufacture and noted in the test

report, based on the following criteria:

Electrostatic discharge

There shall be no damage, malfunction or change of status due to the conditioning.

Flickering of an indicator during the application of discharge is permissible, providing that is no residual change in the EUT or any change in outputs, which could be interpreted by associated equipment as a change.

Radiated electromagnetic fields

There shall be no damage, malfunction or change of status due to the conditioning.

Flickering of an indicator during the application of discharge is permissible, providing which could be interpreted by associated equipment as a change, and no such

Flickering of indicators occurs at a field strength of 3 V/m.

For components of CCTV systems, where the picture is allowed at 10 V/m, providing.

(a) there is no permanent damage or change to EUT

(e.g. no corruption of memory or changes to programmable setting etc.)

(b) at 3 V/m, any deterioration of the picture is so minor that the system could still be used; and

(c) there is no observable deterioration of the picture at 1 V/m.

Fast transient burst / slow high energy voltage surge

There shall be no damage, malfunction or change of status due to the conditioning.
Flickering of an indicator during the application of discharge is permissible, providing
That there is no residual is permissible, providing that there is no residual change in the EUT or
any
change in outputs, which could be interpreted by associated equipment as a change.

Conducted RF immunity

There shall be no damage, malfunction or change of status due to the conditioning.
Flickering of an indicator during the application of discharge is permissible, providing
That there is no residual is permissible, providing that there is no residual change in the EUT or
any
change in outputs, which could be interpreted by associated equipment as a change,
and no such flickering of indicators oeuvres at $U = 130 \text{ dB}\mu\text{V}$.

For component of CCTV systems, where the status is monitored by observing the TV picture,
then deterioration of the picture is allowed at $U = 140 \text{ dB}\mu\text{V}$, providing:

- (a) there is no permanent damage or change to the EUT
(e.g. no corruption of memory or changes to programmable settings etc.)
- (b) at $U = 130 \text{ dB}\mu\text{V}$, any deterioration of the picture is so minor that the system could
still be used; and
- (c) there in no observable deterioration of the picture at $U = 120 \text{ dB}\mu\text{V}$.

Voltage dip/interruption / Voltage variation

There shall be no damage, malfunction or change of status due to the conditioning.
Flickering of an indicator during the conditioning is permissible, providing that there is no
residual
change in the EUT or any change in outputs, which could be interpreted by associated
equipment
as a change. The EUT shall meet the acceptance criteria for the functional test, after the
conditioning.

3.1 Electrostatic Discharge

Reference Standard

EN 61000-4-2:2009

Test Date

Aug. 11, 2019

Test Location

EMS-ESD: Electro wave Shieldroom #7

Test Equipment

Used	Description	Model Number	Manufacturer	Serial Number	Cal. Due
<input checked="" type="checkbox"/>	ESD SIMULATOR	ESS-2000	Noise Ken	ESS01Z0454	10, 11, 2019
<input checked="" type="checkbox"/>	HCP	-	KES	-	-
<input checked="" type="checkbox"/>	VCP	-	KES	-	-

Test Conditions

Temperature: 23,5 °C
Relative Humidity: 52,9 % R.H.
Atmospheric Pressure: 99,5 kPa

Test Specifications

Discharge Factor: ≥ 1 s

Discharge Impedance: 330 ohm / 150 pF

Kind of Discharge: Air, Contact (direct and indirect)

Polarity: Positive and Negative

Number of Discharge: 10 at all locations for Air discharge
10 at all locations for Contact discharge

Discharge Voltage:	Contact	Air	HCP	VCP
	<input type="checkbox"/> 2 kV	<input checked="" type="checkbox"/> 2 kV	<input type="checkbox"/> 2 kV	<input type="checkbox"/> 2 kV
	<input type="checkbox"/> 4 kV	<input checked="" type="checkbox"/> 4 kV	<input type="checkbox"/> 4 kV	<input type="checkbox"/> 4 kV
	<input checked="" type="checkbox"/> 6 kV	<input type="checkbox"/> 6 kV	<input checked="" type="checkbox"/> 6 kV	<input checked="" type="checkbox"/> 6 kV
	<input type="checkbox"/> 8 kV	<input checked="" type="checkbox"/> 8 kV	<input type="checkbox"/> 8 kV	<input type="checkbox"/> 8 kV
	<input type="checkbox"/> 15 kV	<input type="checkbox"/> 15 kV	<input type="checkbox"/> 15 kV	<input type="checkbox"/> 15 kV

Notes: HCP: Horizontal coupling plane
VCP: Vertical coupling plane

Required Performance Criteria: Complied

This report shall not be reproduced except in full, without the written approval of KES Co., Ltd.
The results shown in this test report refer only to the sample(s) tested unless otherwise stated.
The authenticity of the test report, contact shchoi@kes.co.kr

Location of Discharge:

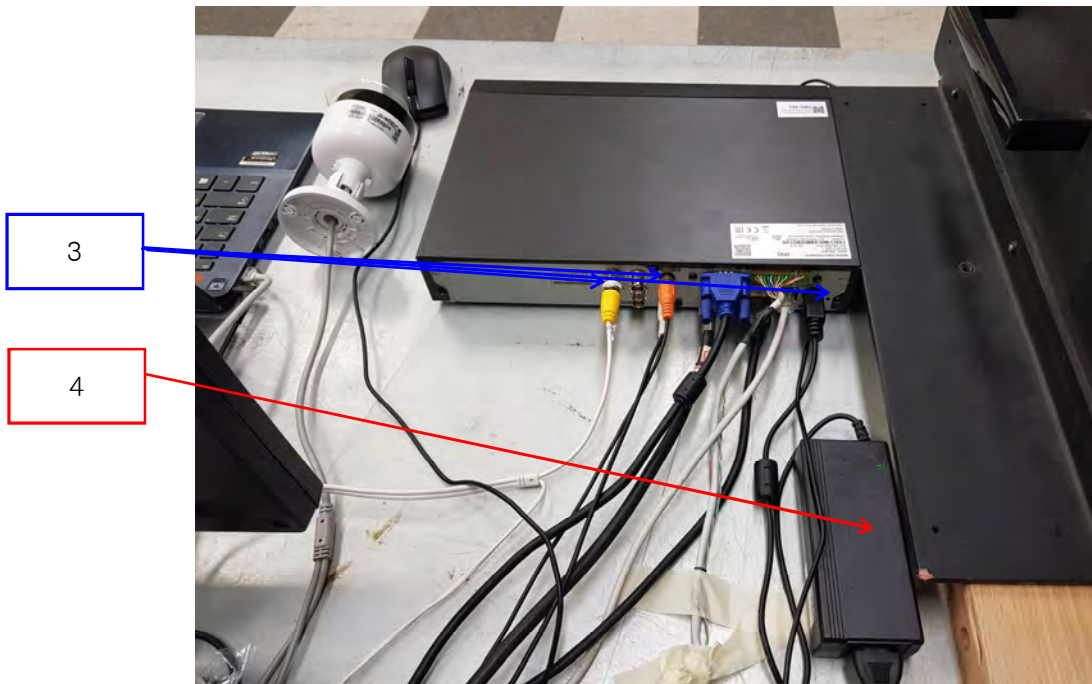
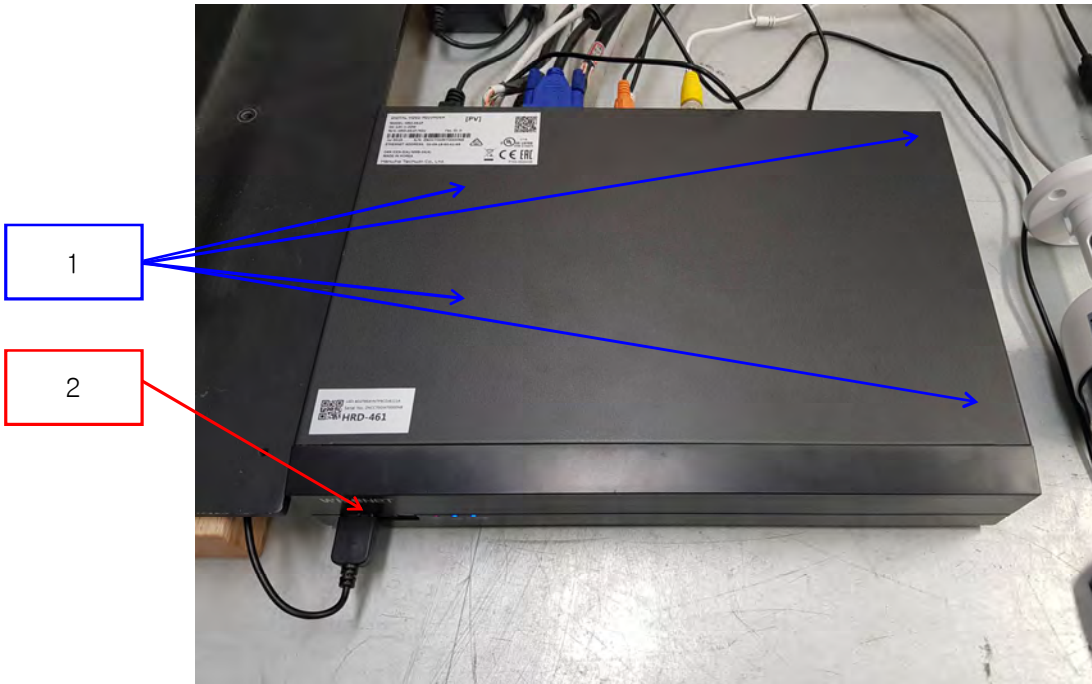
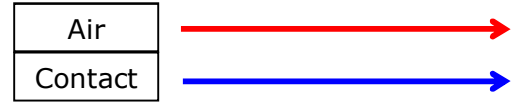

This report shall not be reproduced except in full, without the written approval of KES Co., Ltd.
 The results shown in this test report refer only to the sample(s) tested unless otherwise stated.
 The authenticity of the test report, contact shchoi@kes.co.kr

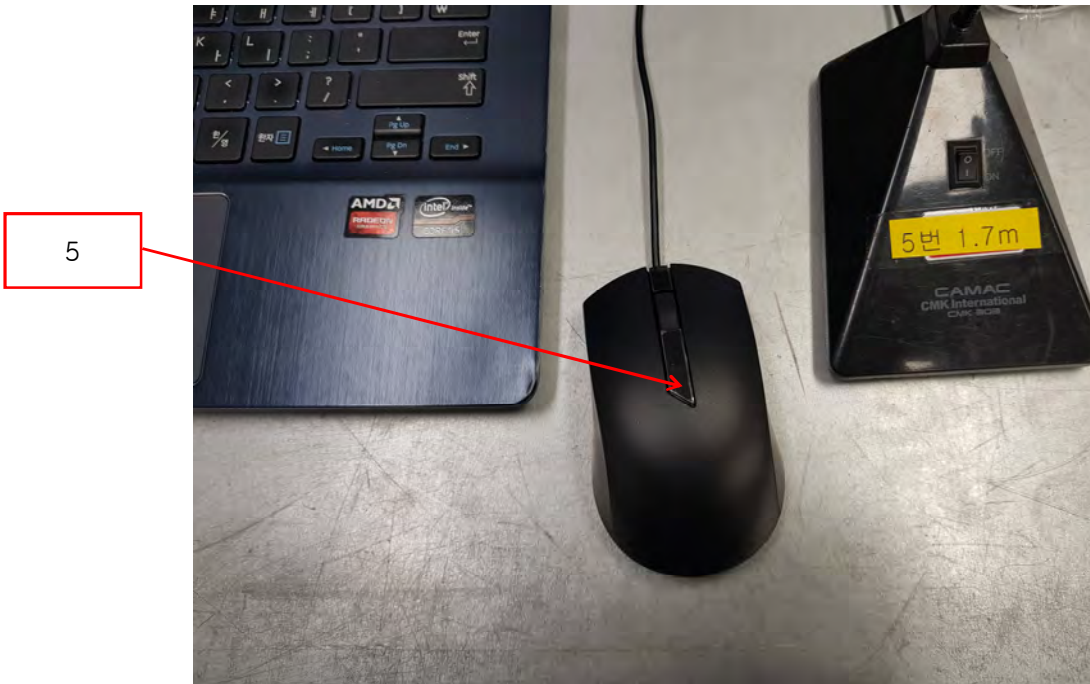



Test Data

Indirect Discharge

No.	Test Point	Discharge Method	Observations	Remarks
1	HCP Contact	Contact Discharge	Complied	-
2	VCP Contact	Contact Discharge	Complied	-

Direct Discharge

No.	Test Point	Discharge Method	Observations	Remarks
1	Enclosure	Contact Discharge	Complied	-
2	Front USB Port	Air Discharge	Complied	-
3	Back Panel	Air Discharge	Complied	-
4	AC/DC Adapter	Air Discharge	Complied	-
5	Mouse	Air Discharge	Complied	-

Note: "Blank" = Not performed

Observations:

Complied – No degradation of function

Test Results

- PASS Required Performance Criteria
- NOT PASS Required Performance Criteria

Remarks

PASS Required Performance Criteria

This report shall not be reproduced except in full, without the written approval of KES Co., Ltd.
The results shown in this test report refer only to the sample(s) tested unless otherwise stated.
The authenticity of the test report, contact shchoi@kes.co.kr



3.2 Radiated Electric Field Immunity

Reference Standard

EN 61000-4-3:2006 +A2:2010

Test Date

Aug. 08, 2019

Test Location

EMS-RS: SEMI ANECHOIC CHAMBER #2 SEMI ANECHOIC CHAMBER #3

Test Equipment

Used	Description	Model Number	Manufacturer	Serial Number	Cal. Due
<input checked="" type="checkbox"/>	EMS Test S/W	EMC32	R & S	10.10.02	-
<input checked="" type="checkbox"/>	SIGNAL GENERATOR	SMB 100A	R & S	177586	08, 06, 2020
<input checked="" type="checkbox"/>	BROADBAND AMPLIFIER	BBA100	R & S	101239	08, 06, 2020
<input checked="" type="checkbox"/>	BROADBAND AMPLIFIER	100S1G6M1	AR	579931	08, 06, 2020
<input checked="" type="checkbox"/>	POWER METER	NRP2	R & S	103475	08, 06, 2020
<input checked="" type="checkbox"/>	AVG POWER SENSOR	NRP-Z91	R & S	102526	08, 06, 2020
<input checked="" type="checkbox"/>	AVG POWER SENSOR	NRP-Z91	R & S	102527	08, 06, 2020
<input checked="" type="checkbox"/>	STACKED DOUBLE LOG-PER- ANTENNA	STPL9128 E	Schwarzbeck	9128ES-121	-
<input checked="" type="checkbox"/>	DIRECTIONAL COUPLER	KYDC-D1070-DX40	KY TELECOM	KY150001	08, 06, 2020
<input checked="" type="checkbox"/>	DOUBLE RIDGED HORN ANTENNA	SAS-571	A.H.SYSTEM,INC	781	03, 12, 2021

Test Conditions

Temperature: 24,4 °C
Relative Humidity: 53,6 % R.H.
Atmospheric Pressure: 99,9 kPa

This report shall not be reproduced except in full, without the written approval of KES Co., Ltd.
The results shown in this test report refer only to the sample(s) tested unless otherwise stated.
The authenticity of the test report, contact shchoi@kes.co.kr



Test Specifications

Antenna Polarization: Horizontal & vertical unless indicated otherwise

Antenna Distance: 3 m

Field Strength: 1 V/m 3 V/m
 10 V/m

Frequency Range: 80 MHz to 1 GHz 1,4 GHz to 2,7 GHz
 80 MHz to 2,7 GHz

Modulation: AM, 80 %, 1 kHz sine wave
 PM, 1 Hz (0,5 s ON : 0,5 s OFF)

Frequency step: 1 % step

Dwell Time: 1 s 3 s

of Sides Radiated: 4

Required Performance Criteria: Complied



Test Data

Side Exposed	Observations	
	Horizontal	Vertical
Front	Complied	Complied
Right	Complied	Complied
Back	Complied	Complied
Left	Complied	Complied

Note: "Blank" = Not performed

Observations:
Complied – No degradation of function

Test Results

- PASS Required Performance Criteria
- NOT PASS Required Performance Criteria

Remarks

PASS Required Performance Criteria

This report shall not be reproduced except in full, without the written approval of KES Co., Ltd.
The results shown in this test report refer only to the sample(s) tested unless otherwise stated.
The authenticity of the test report, contact shchoi@kes.co.kr

3.3 Electrical Fast Transients/Bursts

Reference Standard

EN 61000-4-4:2012

Test Date

Aug. 11, 2019

Test Location

EMS-EFT: Electro wave Shieldroom #7

Test Equipment

Used	Description	Model Number	Manufacturer	Serial Number	Cal. Due
<input checked="" type="checkbox"/>	EMS Test S/W	iec.control	EM TEST	5.4.7	-
<input checked="" type="checkbox"/>	ULTRA COMPACT SIMULATOR	UCS 500N7	EM TEST	P1608172950	11, 27, 2019
<input checked="" type="checkbox"/>	MOTOR VARIAC	MV2616	EM TEST	P1552169719	11, 27, 2019
<input checked="" type="checkbox"/>	CAPACITIVE COUPLING CLAMP	HFK	EM TEST	P1633183115	11, 26, 2019

Test Conditions

Temperature: 23,5 °C
Relative Humidity: 52,9 % R.H.
Atmospheric Pressure: 99,5 kPa

Test Specifications

Pulse Amplitude & Polarity: ± 1.0 kV ± 2.0 kV
(AC Power Lines) ± 4.0 kV

Pulse Amplitude & Polarity: ± 0.5 kV ± 1.0 kV
(Other supply / Signal Lines) ± 2.0 kV

Burst Period: 300 ms 2 s

Repetition Rate: 5 kHz 100 kHz

Duration of Test Voltage: ≥ 1 min

Required Performance Criteria: Complied

This report shall not be reproduced except in full, without the written approval of KES Co., Ltd.
The results shown in this test report refer only to the sample(s) tested unless otherwise stated.
The authenticity of the test report, contact shchoi@kes.co.kr

Test Data

Input a.c. power ports – Coupling/Decoupling Network used

Mode of Application	Observations	
	(+) Burst (kV)	(-) Burst (kV)
L	Complied	Complied
N	Complied	Complied
PE	Complied	Complied
L - N	Complied	Complied
L - PE	Complied	Complied
N - PE	Complied	Complied
L - N - PE	Complied	Complied

Input d.c. power ports – Coupling/Decoupling Network used

Mode of Application	Observations	
	(+) Burst (kV)	(-) Burst (kV)
-	-	-

Signal ports and telecommunication ports – Coupling Clamp used

Mode of Application	Observations	
	(+) Burst (kV)	(-) Burst (kV)
NETWORK	Complied	Complied
VIDEO IN	Complied	Complied
SPOT	Complied	Complied
RS-485	Complied	Complied
Alarm Cable	Complied	Complied
Button Alarm Cable	Complied	Complied

Note: "Blank" = Not performed

Observations:

Complied – No degradation of function

Test Results

PASS Required Performance Criteria

NOT PASS Required Performance Criteria

Remarks

PASS Required Performance Criteria

3.4 Surge Transients

Reference Standard

EN 61000-4-5:2014

Test Date

Aug. 11, 2019

Test Location

EMS-Surge: Electro wave Shieldroom #7

Test Equipment

Used	Description	Model Number	Manufacturer	Serial Number	Cal. Due
<input checked="" type="checkbox"/>	EMS Test S/W	iec.control	EM TEST	5.4.7	-
<input checked="" type="checkbox"/>	ULTRA COMPACT SIMULATOR	UCS 500N7	EM TEST	P1608172950	11, 27, 2019
<input checked="" type="checkbox"/>	MOTOR VARIAC	MV2616	EM TEST	P1552169719	11, 27, 2019
<input type="checkbox"/>	CAPACITIVE COUPLING CLAMP	HFK	EM TEST	P1633183115	11, 26, 2019

Test Conditions

Temperature: 23,5 °C
 Relative Humidity: 52,9 % R.H.
 Atmospheric Pressure: 99,5 kPa

This report shall not be reproduced except in full, without the written approval of KES Co., Ltd.
 The results shown in this test report refer only to the sample(s) tested unless otherwise stated.
 The authenticity of the test report, contact shchoi@kes.co.kr



Test Specifications

AC Power Lines

Source Impedance: 12 ohm for common Mode and 2 ohm for differential Mode

Surge Amplitude : Common Mode
 (0,5 / 1,0 / 2,0) kV
Differential Mode
 (0,5 / 1,0) kV

Number of Surges: 5 surges per angle

Angle: 0°, 90°, 180°, 270° (input a.c. power port)

Polarity: Positive & Negative

Repetition Rate: 1 surge per min 1 surge per 30 sec.

Required Performance Criteria: Complied

Other supply / Signal Lines

Source Impedance: 42 ohm for common Mode

Surge Amplitude: Common Mode
 (0,5 / 1,0) kV

Number of Surges: 5 Surges

Polarity: Positive & Negative

Repetition Rate: 1 surge per min 1 surge per 30 sec.

Required Performance Criteria: Complied



Test Data

Line to Line – Differential Mode

Mode of Application	Observations	
	(+) Surge (kV)	(-) Surge (kV)
L – N	Complied	Complied

Line to Earth – Common Mode

Mode of Application	Observations	
	(+) Surge (kV)	(-) Surge (kV)
L – PE	Complied	Complied
N – PE	Complied	Complied

Signal Lines

Line to Earth – Common Mode

Mode of Application	Observations	
	(+) Surge (kV)	(-) Surge (kV)
-	-	-

Note: "Blank" = Not performed

Observations:

Complied – No degradation of function

Test Results

- PASS Required Performance Criteria
- NOT PASS Required Performance Criteria
- NOT APPLICABLE

Remarks

PASS Required Performance Criteria

Other supply/signal lines : No test is required because it is not permitted to connect cables > 30 m long.

3.5 Conducted Disturbance

Reference Standard

EN 61000-4-6:2014

Test Date

Aug. 10, 2019

Test Location

EMS-CS: Electro wave Shieldroom #6

Test Equipment

Used	Description	Model Number	Manufacturer	Serial Number	Cal. Due
<input checked="" type="checkbox"/>	EMS Test S/W	icd.control	EM TEST	5.3.11	-
<input checked="" type="checkbox"/>	CONTINUOUS WAVE SIMULATOR	CWS 500N1.4	EM TEST	P1602169880	11, 26, 2019
<input checked="" type="checkbox"/>	ATTENUATOR	ATT 6/80	EM TEST	P1614178148	11, 26, 2019
<input checked="" type="checkbox"/>	CDN	CDN M016	TESEQ	43694	11, 26, 2019
<input type="checkbox"/>	CDN	CDN M016	TESEQ	43697	11, 26, 2019
<input checked="" type="checkbox"/>	CDN	CDN T800	TESEQ	42800	11, 26, 2019
<input checked="" type="checkbox"/>	EM CLAMP	KEMZ 801A	TESEQ	44099	11, 27, 2019

Test Conditions

Temperature: 23,4 °C
Relative Humidity: 54,7 % R.H.
Atmospheric Pressure: 99,4 kPa

Test Specifications

Frequency range: 150 kHz to 100 MHz 150 kHz to 80 MHz

Voltage Level: 1 Vrms 3 Vrms
 10 Vrms

Modulation: AM, 80 %, 1 kHz sine wave
 PM, 1 Hz (0,5 s ON : 0,5 s OFF)

Frequency step: 1 % step

Dwell Time: 1 s 3 s

Required Performance Criteria: Complied

This report shall not be reproduced except in full, without the written approval of KES Co., Ltd.
The results shown in this test report refer only to the sample(s) tested unless otherwise stated.
The authenticity of the test report, contact shchoi@kes.co.kr

Test Data

Input a.c. power ports

Coupling Location (Line Stressed)	Coupling Method	Observations
L - N - PE	CDN	Complied

Input d.c. power ports

Coupling Location (Line Stressed)	Coupling Method	Observations
-	-	-

Signal ports and telecommunication ports

Coupling Location (Line Stressed)	Coupling Method	Observations
NETWORK	CDN	Complied
VIDEO IN	Clamp	Complied
SPOT	Clamp	Complied
RS-485	Clamp	Complied
Alarm Cable	Clamp	Complied
Button Alarm Cable	Clamp	Complied

Notes: CDN = Coupling Decoupling Network
 "blank" = Not performed

Observations:
 Complied - No degradation of function

Test Results

PASS Required Performance Criteria
 NOT PASS Required Performance Criteria

Remarks

PASS Required Performance Criteria

3.6 Voltage Dips and Short Interruptions

Reference Standard

EN 61000-4-11:2004

Test Date

Aug. 11, 2019

Test Location

EMS-Voltage dip: Electro wave Shieldroom #7

Test Equipment

Used	Description	Model Number	Manufacturer	Serial Number	Cal. Due
<input checked="" type="checkbox"/>	EMS Test S/W	iec.control	EM TEST	5.4.7	-
<input checked="" type="checkbox"/>	ULTRA COMPACT SIMULATOR	UCS 500N7	EM TEST	P1608172950	11, 27, 2019
<input checked="" type="checkbox"/>	MOTOR VARIAC	MV2616	EM TEST	P1552169719	11, 27, 2019

Test ConditionsTemperature: 23,5 °C
Relative Humidity: 52,9 % R.H.
Atmospheric Pressure: 99,5 kPa



Test Specifications & Observations/Remarks

- Voltage Dips and Short Interruptions

<u>Test Level</u>	<u>Duration [in period/ms (50 Hz)]</u>	<u>Results</u>
<input checked="" type="checkbox"/> 20 % dip	<input checked="" type="checkbox"/> 250 / 5 000	<u>Complied</u>
<input checked="" type="checkbox"/> 30 % dip	<input checked="" type="checkbox"/> 25 / 500	<u>Complied</u>
<input checked="" type="checkbox"/> 60 % dip	<input checked="" type="checkbox"/> 10 / 200	<u>Complied</u>
<input checked="" type="checkbox"/> 100 % dip	<input checked="" type="checkbox"/> 250 / 5 000	<u>Complied</u>

- Voltage variations

<input checked="" type="checkbox"/> Unom + 10 %	<input checked="" type="checkbox"/> 253.0 V (ac)	<u>Complied</u>
<input checked="" type="checkbox"/> Unom - 15 %	<input checked="" type="checkbox"/> 195.5 V (ac)	<u>Complied</u>

Observations:

Complied – No degradation of function

Test Results

- PASS Required Performance Criteria
- NOT PASS Required Performance Criteria
- NOT APPLICABLE

Remarks

PASS Required Performance Criteria

APPENDIX A – TEST DATA

Conducted Emissions at Mains Power Ports

[HOT]

Common Information

Test Description:	Conducted Emission
Model No.:	HRX-420P
Phase:	
Mode:	H
Operator Name:	KES

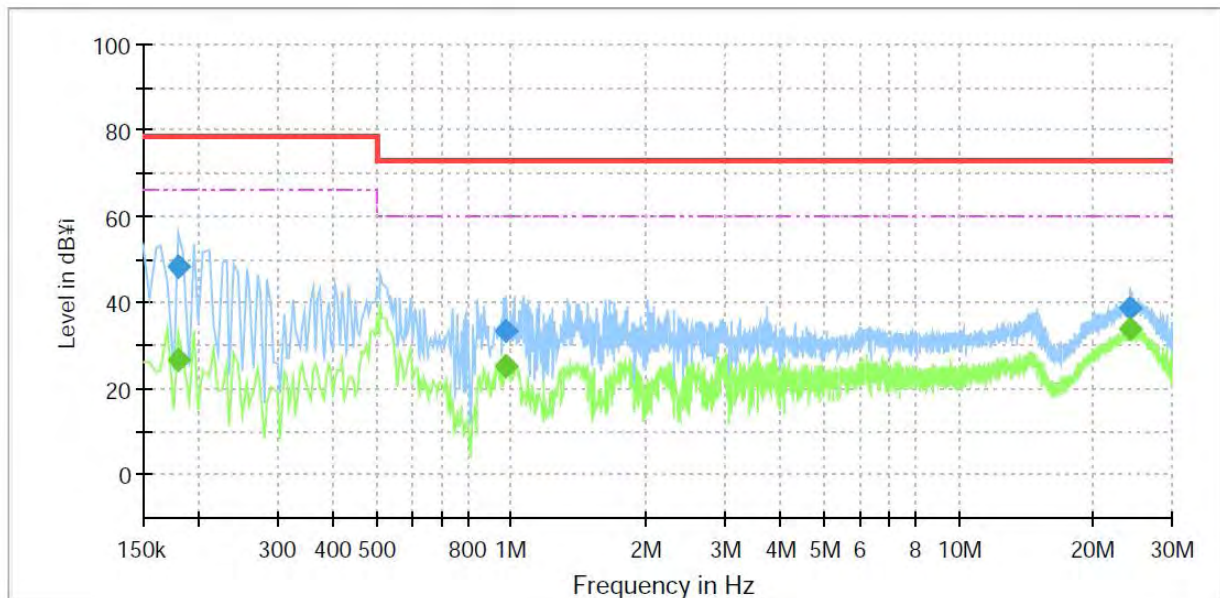

Final Result

Frequency (MHz)	QuasiPeak (dBµV)	CAverage (dBµV)	Limit (dBµV)	Margin (dB)	Meas. Time (ms)	Bandwidth (kHz)	Line	Corr. (dB)
0.180000	--	26.51	66.00	39.49	1000.0	9.000	L1	19.5
0.180000	48.32	--	79.00	30.68	1000.0	9.000	L1	19.5
0.975000	--	25.45	60.00	34.55	1000.0	9.000	L1	20.3
0.975000	33.30	--	73.00	39.70	1000.0	9.000	L1	20.3
24.060000	--	33.90	60.00	26.10	1000.0	9.000	L1	20.5
24.060000	38.82	--	73.00	34.18	1000.0	9.000	L1	20.5

This report shall not be reproduced except in full, without the written approval of KES Co., Ltd.
 The results shown in this test report refer only to the sample(s) tested unless otherwise stated.
 The authenticity of the test report, contact shchoi@kes.co.kr

[NEUTRAL]

Common Information

Test Description:	Conducted Emission
Model No.:	HRX-420P
Phase:	
Mode:	N
Operator Name:	KES

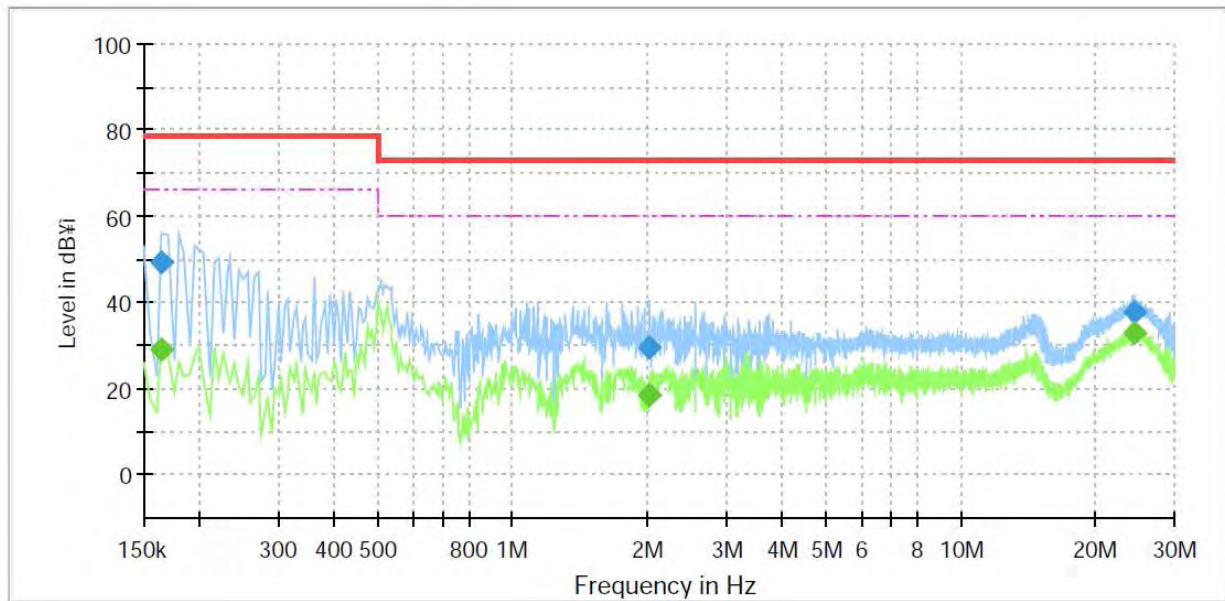

Final Result

Frequency (MHz)	QuasiPeak (dBµV)	CAverage (dBµV)	Limit (dBµV)	Margin (dB)	Meas. Time (ms)	Bandwidth (kHz)	Line	Corr. (dB)
0.165000	---	28.97	66.00	37.03	1000.0	9.000	N	19.5
0.165000	49.52	---	79.00	29.48	1000.0	9.000	N	19.5
2.025000	---	18.62	60.00	41.38	1000.0	9.000	N	20.5
2.025000	29.48	---	73.00	43.52	1000.0	9.000	N	20.5
24.400000	---	32.90	60.00	27.10	1000.0	9.000	N	20.6
24.400000	37.64	---	73.00	35.36	1000.0	9.000	N	20.6

◆ Calculation

QuasiPeak [dBµV] / CAverage [dBµV] = Reading Value [dBµV] + Corr. [dB]

QuasiPeak / CAverage : The Final Value

Reading Value : Not shown in the table.

Corr. : Correction values (LISN FACTOR + (Cable Loss + Pulse Limiter FACTOR))

Conducted Emissions at Telecommunication Ports

[1 000 Mbps]

Common Information

Test Description:	Telecommunication Emission
Model No.:	HRX-420P
Mode :	
Speed :	1 000 Mbps
Operator Name:	KES

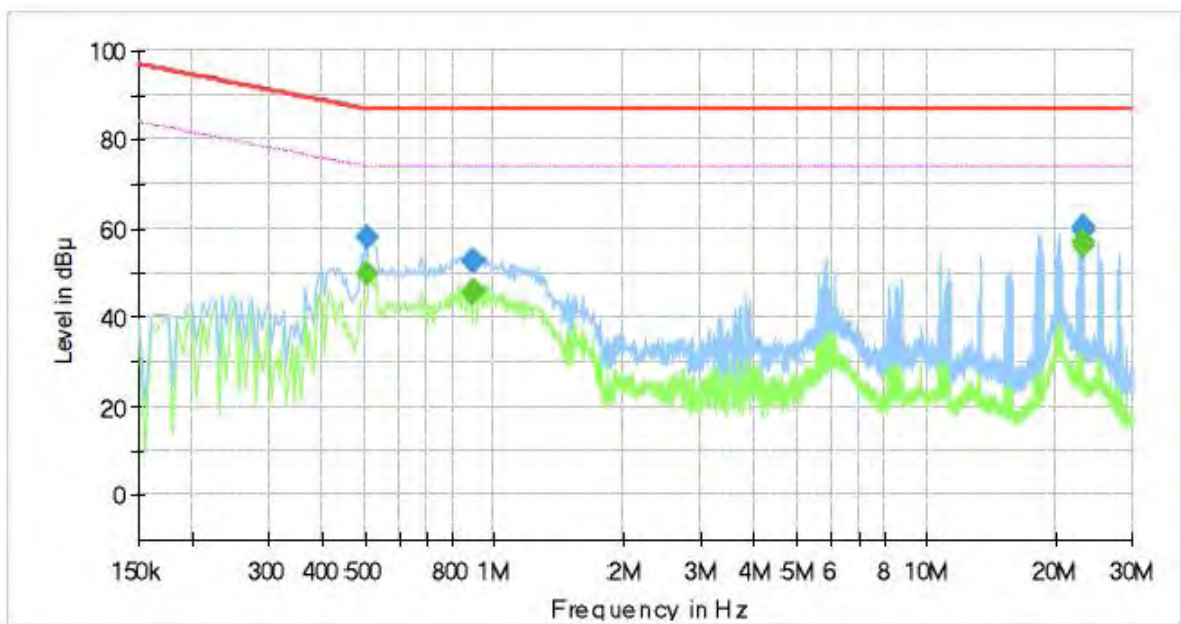

Final Result

Frequency (MHz)	QuasiPeak (dBµV)	CAverage (dBµV)	Limit (dBµV)	Margin (dB)	Meas. Time (ms)	Bandwidth (kHz)	Line	Corr. (dB)
0.510000	---	50.02	74.00	23.98	1000.0	9.000	Single Line	19.9
0.510000	58.20	---	87.00	28.80	1000.0	9.000	Single Line	19.9
0.890000	---	45.53	74.00	28.47	1000.0	9.000	Single Line	20.2
0.890000	52.63	---	87.00	34.37	1000.0	9.000	Single Line	20.2
0.895000	---	46.05	74.00	27.95	1000.0	9.000	Single Line	20.2
0.895000	52.87	---	87.00	34.13	1000.0	9.000	Single Line	20.2
23.125000	---	57.19	74.00	16.81	1000.0	9.000	Single Line	20.5
23.125000	60.39	---	87.00	26.61	1000.0	9.000	Single Line	20.5
23.130000	---	56.22	74.00	17.78	1000.0	9.000	Single Line	20.5
23.130000	59.57	---	87.00	27.43	1000.0	9.000	Single Line	20.5

◆ Calculation

QuasiPeak[dBuV] / CAverage [dBuV] = Reading Value[dBuV] + Corr. [dB]

QuasiPeak / CAverage : The Final Value

Reading Value : Not shown in the table.

Corr. : Correction values (ISN FACTOR + (Cable Loss + Pulse Limiter FACTOR))

This report shall not be reproduced except in full, without the written approval of KES Co., Ltd.
The results shown in this test report refer only to the sample(s) tested unless otherwise stated.
The authenticity of the test report, contact shchoi@kes.co.kr



Radiated Electric Field Emissions(Below 1 GHz)

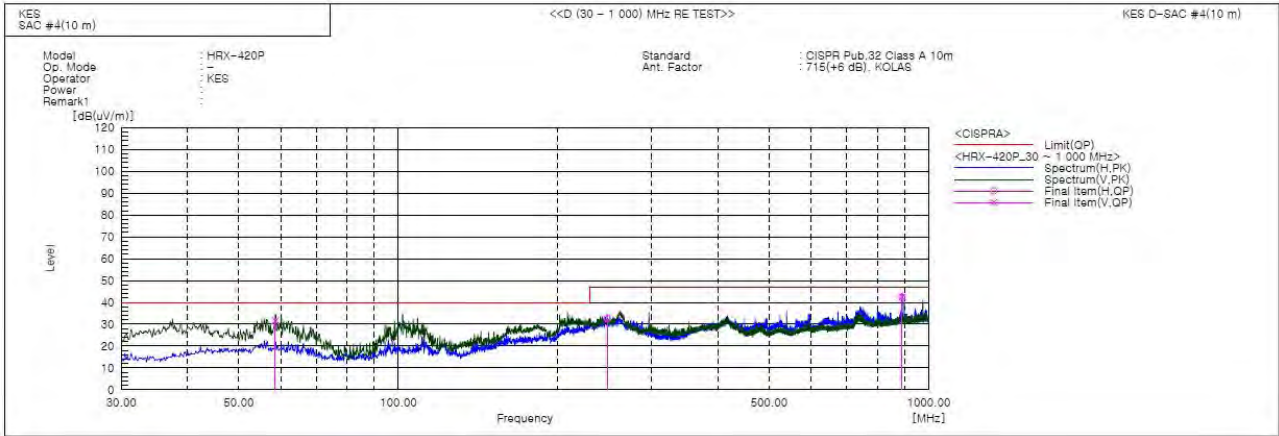

Final Result

No.	Frequency [MHz]	(P)	Reading QP [dB(uV)]	c.f [dB(1/m)]	Result QP [dB(uV/m)]	Limit QP [dB(uV/m)]	Margin QP [dB]	Height [cm]	Angle [deg]	Remark
1	58.615	V	53.8	-22.2	31.6	40.0	8.4	110.0	218.0	
2	247.644	H	52.6	-20.0	32.6	47.0	14.4	400.0	46.0	
3	890.948	V	48.3	-5.8	42.5	47.0	4.5	164.0	327.0	
4	890.996	H	48.0	-5.8	42.2	47.0	4.8	238.0	211.0	

◆ Calculation - SEMI ANECHOIC CHAMBER #4(10 m)

$$\text{Result(QP)} [\text{dB}(\mu\text{V}/\text{m})] = (\text{Reading(QP)}[\text{dB}(\mu\text{V})] + \text{c.f}[\text{dB}(1/\text{m})])$$

$$\text{Margin(QP)}[\text{dB}] = \text{Limit}[\text{dB}(\mu\text{V}/\text{m})] - \text{Result(QP)} [\text{dB}(\mu\text{V}/\text{m})]$$

Reading(QP) : Reading value, Result(QP) : Reading value + Factor value

Limit(QP) : Limit value, c.f : (ANT Factor + Cable Loss - Preamp Factor), Margin: Margin value



Radiated Electric Field Emissions(Above 1 GHz)

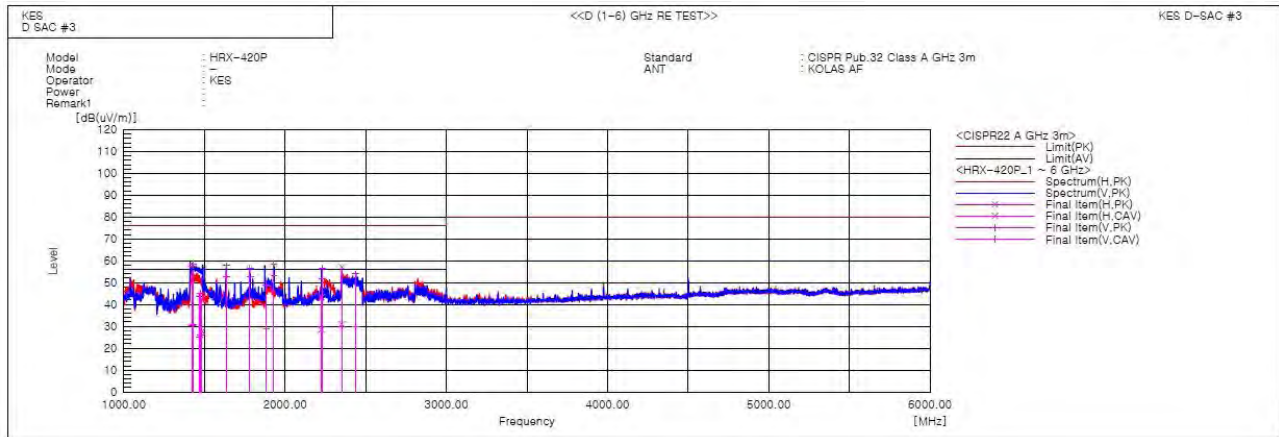

Final Result

No.	Frequency [MHz]	(P)	Reading PK [dB(uV)]	Reading CAV [dB(uV)]	c.f [dB(1/m)]	Result PK [dB(uV/m)]	Result CAV [dB(uV/m)]	Limit PK [dB(uV/m)]	Limit AV [dB(uV/m)]	Margin PK [dB]	Margin CAV [dB]	Height [cm]	Angle [deg]	Remark
1	1421.938	V	64.6	37.2	-7.0	57.6	30.2	76.0	56.0	18.4	25.8	100.0	32.2	
2	1431.063	V	65.6	38.0	-7.0	58.6	31.0	76.0	56.0	17.4	25.0	100.0	29.4	
3	1468.154	V	50.5	31.9	-6.7	43.8	25.2	76.0	56.0	32.2	30.8	100.0	247.2	
4	1475.665	V	52.0	33.0	-6.7	45.3	26.3	76.0	56.0	30.7	29.7	100.0	246.3	
5	1484.363	H	49.2	34.3	-6.6	42.6	27.7	76.0	56.0	33.4	28.3	100.0	208.2	
6	1633.400	V	63.2	38.1	-5.4	57.8	32.7	76.0	56.0	18.2	3.3	100.0	207.4	
7	1781.920	V	60.1	36.2	-3.6	56.5	32.6	76.0	56.0	19.5	3.4	100.0	195.7	
8	1880.389	V	51.5	31.6	-2.7	48.8	28.9	76.0	56.0	27.2	27.1	100.0	211.7	
9	1930.420	V	60.9	35.6	-2.3	58.6	33.3	76.0	56.0	17.4	2.7	100.0	178.4	
10	2224.431	H	44.7	29.9	-1.3	43.4	28.6	76.0	56.0	32.6	27.4	100.0	137.4	
11	2227.210	V	58.0	33.0	-1.3	56.7	31.7	76.0	56.0	19.3	4.3	100.0	158.1	
12	2351.360	H	58.0	31.7	-0.8	57.2	30.9	76.0	56.0	18.8	25.1	100.0	82.0	
13	2436.860	V	54.4	30.3	-0.4	54.0	29.9	76.0	56.0	22.0	26.1	100.0	47.5	

◆ Calculation

Result(PK/CAV) [dB(μV/m)] = (Reading(PK/CAV)[dB(μV)] + c.f[dB(1/m)])

Margin(PK/CAV)[dB] = Limit[dB(μV/m)] - Result(PK/CAV) [dB(μV/m)]

Reading(PK/CAV) : Reading value, Result(PK/CAV) : Reading value + Factor value

Limit(QP) : Limit value, c.f : (ANT Factor + Cable Loss - Preamp Factor), Margin: Margin value

This report shall not be reproduced except in full, without the written approval of KES Co., Ltd.
The results shown in this test report refer only to the sample(s) tested unless otherwise stated.
The authenticity of the test report, contact shchoi@kes.co.kr



Harmonic Current Emissions and Voltage Fluctuations and Flicker

Average harmonic current results				
Hn	I _{eff} [A]	% of Limit	Limit [A]	Result
1	0.049			
2	0.004	0.342	1.080	n/a
3	0.042	1.813	2.300	PASS
4	0.003	0.809	0.430	n/a
5	0.041	3.578	1.140	PASS
6	0.005	1.551	0.300	n/a
7	0.040	5.211	0.770	PASS
8	0.003	1.514	0.230	n/a
9	0.040	9.898	0.400	PASS
10	0.003	1.665	0.184	n/a
11	0.038	11.662	0.330	PASS
12	0.003	2.082	0.153	n/a
13	0.037	17.631	0.210	PASS
14	0.003	2.502	0.131	n/a
15	0.035	23.600	0.150	PASS
16	0.003	2.748	0.115	n/a
17	0.034	25.505	0.132	PASS
18	0.003	2.974	0.102	n/a
19	0.032	27.081	0.118	PASS
20	0.003	3.007	0.092	n/a
21	0.030	18.612	0.161	PASS
22	0.003	3.224	0.084	n/a
23	0.028	19.160	0.147	PASS
24	0.003	3.301	0.077	n/a
25	0.026	19.362	0.135	PASS
26	0.002	3.237	0.071	n/a
27	0.024	19.166	0.125	PASS
28	0.002	3.494	0.066	n/a
29	0.022	18.873	0.116	PASS
30	0.002	3.342	0.061	n/a
31	0.020	18.074	0.109	PASS
32	0.002	3.248	0.058	n/a
33	0.018	17.201	0.102	PASS
34	0.002	3.339	0.054	n/a
35	0.016	16.269	0.096	PASS
36	0.001	2.898	0.051	n/a
37	0.014	14.826	0.091	PASS
38	0.001	2.971	0.048	n/a
39	0.012	13.621	0.087	PASS
40	0.001	2.670	0.046	n/a

Harmonic currents less than 0.6% of the input current measured under the test conditions, or less than 5 mA, whichever is greater, are disregarded.

This report shall not be reproduced except in full, without the written approval of KES Co., Ltd.
The results shown in this test report refer only to the sample(s) tested unless otherwise stated.
The authenticity of the test report, contact shchoi@kes.co.kr



Test Data - Harmonics (continued)

Maximum harmonic current results				
Hn	I _{eff} [A]	% of Limit	Limit [A]	Result
1	0.050			
2	0.004	0.269	1.620	n/a
3	0.042	1.223	3.450	PASS
4	0.005	0.733	0.645	n/a
5	0.042	2.437	1.710	PASS
6	0.006	1.228	0.450	PASS
7	0.041	3.552	1.155	PASS
8	0.004	1.220	0.345	n/a
9	0.040	6.691	0.600	PASS
10	0.005	1.747	0.276	n/a
11	0.039	7.896	0.495	PASS
12	0.004	1.773	0.230	n/a
13	0.037	11.898	0.315	PASS
14	0.004	1.945	0.197	n/a
15	0.036	15.920	0.225	PASS
16	0.004	2.105	0.173	n/a
17	0.034	17.280	0.199	PASS
18	0.004	2.310	0.153	n/a
19	0.033	18.306	0.178	PASS
20	0.004	2.602	0.138	n/a
21	0.030	18.853	0.161	PASS
22	0.003	2.614	0.125	n/a
23	0.028	19.373	0.147	PASS
24	0.003	2.806	0.115	n/a
25	0.026	19.534	0.135	PASS
26	0.003	2.892	0.106	n/a
27	0.024	19.335	0.125	PASS
28	0.003	2.753	0.099	n/a
29	0.022	19.032	0.116	PASS
30	0.002	2.698	0.092	n/a
31	0.020	18.229	0.109	PASS
32	0.002	2.650	0.086	n/a
33	0.018	17.342	0.102	PASS
34	0.002	2.686	0.081	n/a
35	0.016	16.430	0.096	PASS
36	0.002	2.427	0.077	n/a
37	0.014	15.080	0.091	PASS
38	0.002	2.325	0.073	n/a
39	0.012	14.001	0.087	PASS
40	0.002	2.241	0.069	n/a

Harmonic currents less than 0.6% of the input current measured under the test conditions, or less than 5 mA, whichever is greater, are disregarded.

This report shall not be reproduced except in full, without the written approval of KES Co., Ltd.
The results shown in this test report refer only to the sample(s) tested unless otherwise stated.
The authenticity of the test report, contact shchoi@kes.co.kr



KES Co., Ltd.

3701, 40, Simin-daero 365beon-gil,
Dongan-gu, Anyang-si, Gyeonggi-do, 14057, Korea
Tel: +82-31-425-6200 / Fax: +82-31-424-0450
www.kes.co.kr

Report No.:
KES-E1-19T0459
Page (45) of (59)

Test Data - Voltage Fluctuations

Maximum Flicker results

Flicker Measurements					
	Plt	Max Pst	Max Dc	Max Dmax	Max Tmax
Line 1:	0.028	0.028	0	< 0.2	0
Limits:	0.65	1	3.3	4	0.5
Results:	PASS	PASS	PASS	PASS	PASS

This report shall not be reproduced except in full, without the written approval of KES Co., Ltd.
The results shown in this test report refer only to the sample(s) tested unless otherwise stated.
The authenticity of the test report, contact shchoi@kes.co.kr

Test Setup Photos and Configuration

Conducted Voltage Emissions

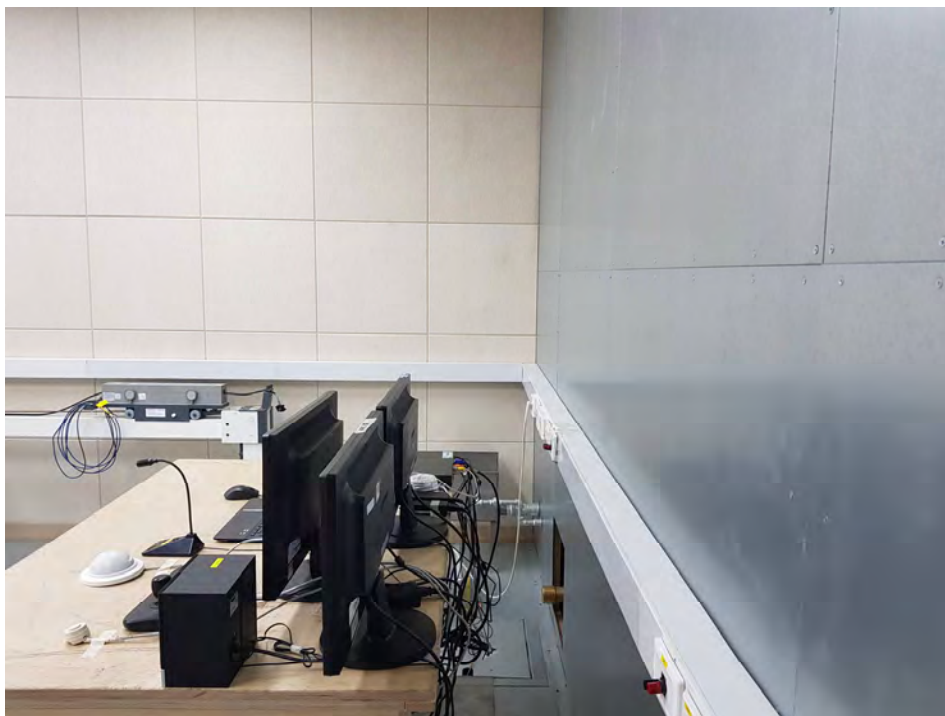

This report shall not be reproduced except in full, without the written approval of KES Co., Ltd.
The results shown in this test report refer only to the sample(s) tested unless otherwise stated.
The authenticity of the test report, contact shchoi@kes.co.kr

Conducted Telecommunication Emissions



This report shall not be reproduced except in full, without the written approval of KES Co., Ltd.
The results shown in this test report refer only to the sample(s) tested unless otherwise stated.
The authenticity of the test report, contact shchoi@kes.co.kr

Radiated Electric Field Emissions(Below 1 GHz)



This report shall not be reproduced except in full, without the written approval of KES Co., Ltd.
The results shown in this test report refer only to the sample(s) tested unless otherwise stated.
The authenticity of the test report, contact shchoi@kes.co.kr

Radiated Electric Field Emissions(Above 1 GHz)

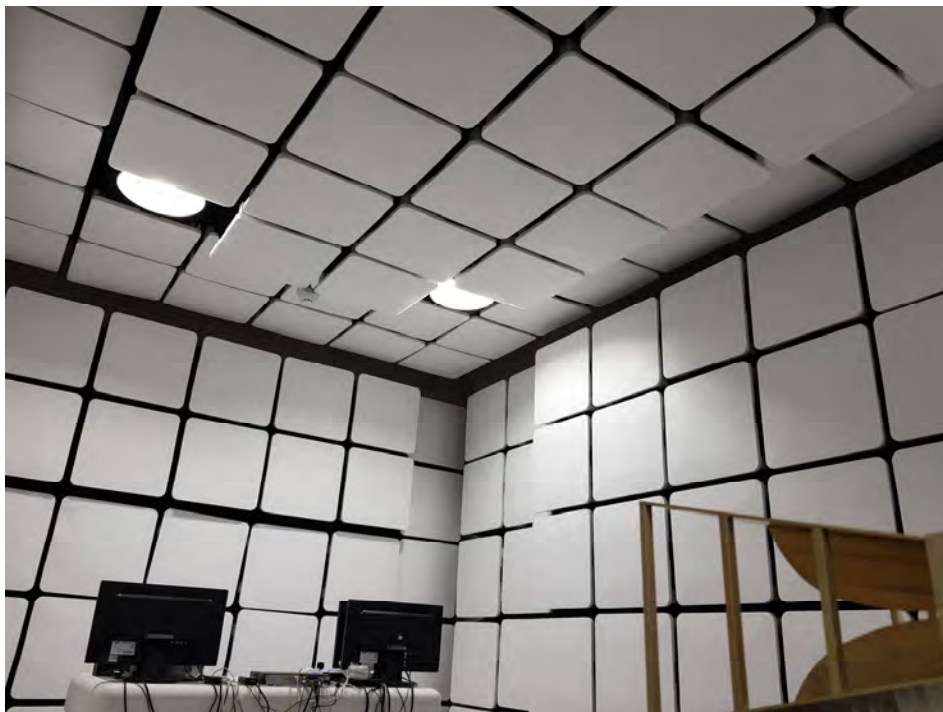

This report shall not be reproduced except in full, without the written approval of KES Co., Ltd.
The results shown in this test report refer only to the sample(s) tested unless otherwise stated.
The authenticity of the test report, contact shchoi@kes.co.kr

Harmonic Current Emissions and Voltage Fluctuations and Flicker



This report shall not be reproduced except in full, without the written approval of KES Co., Ltd.
The results shown in this test report refer only to the sample(s) tested unless otherwise stated.
The authenticity of the test report, contact shchoi@kes.co.kr

Electrostatic Discharge



Radiated Electric Field Immunity

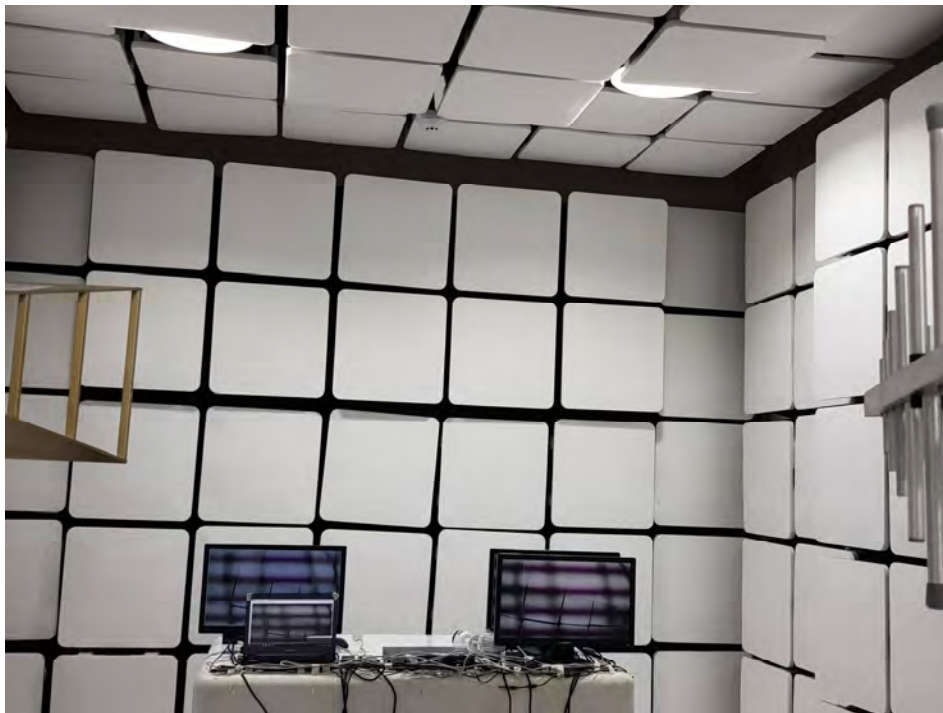

This report shall not be reproduced except in full, without the written approval of KES Co., Ltd.
The results shown in this test report refer only to the sample(s) tested unless otherwise stated.
The authenticity of the test report, contact shchoi@kes.co.kr

Electrical Fast Transients/Bursts



Surge Transients



This report shall not be reproduced except in full, without the written approval of KES Co., Ltd.
The results shown in this test report refer only to the sample(s) tested unless otherwise stated.
The authenticity of the test report, contact shchoi@kes.co.kr

Conducted Disturbance



Voltage Dips and Short Interruptions



This report shall not be reproduced except in full, without the written approval of KES Co., Ltd.
The results shown in this test report refer only to the sample(s) tested unless otherwise stated.
The authenticity of the test report, contact shchoi@kes.co.kr

EUT External Photographs

(Top)



(Bottom)



This report shall not be reproduced except in full, without the written approval of KES Co., Ltd.
The results shown in this test report refer only to the sample(s) tested unless otherwise stated.
The authenticity of the test report, contact shchoi@kes.co.kr

EUT Internal Photographs

(Internal View)



This report shall not be reproduced except in full, without the written approval of KES Co., Ltd.
The results shown in this test report refer only to the sample(s) tested unless otherwise stated.
The authenticity of the test report, contact shchoi@kes.co.kr

EUT Internal View – Main Board

(Top)



(Bottom)

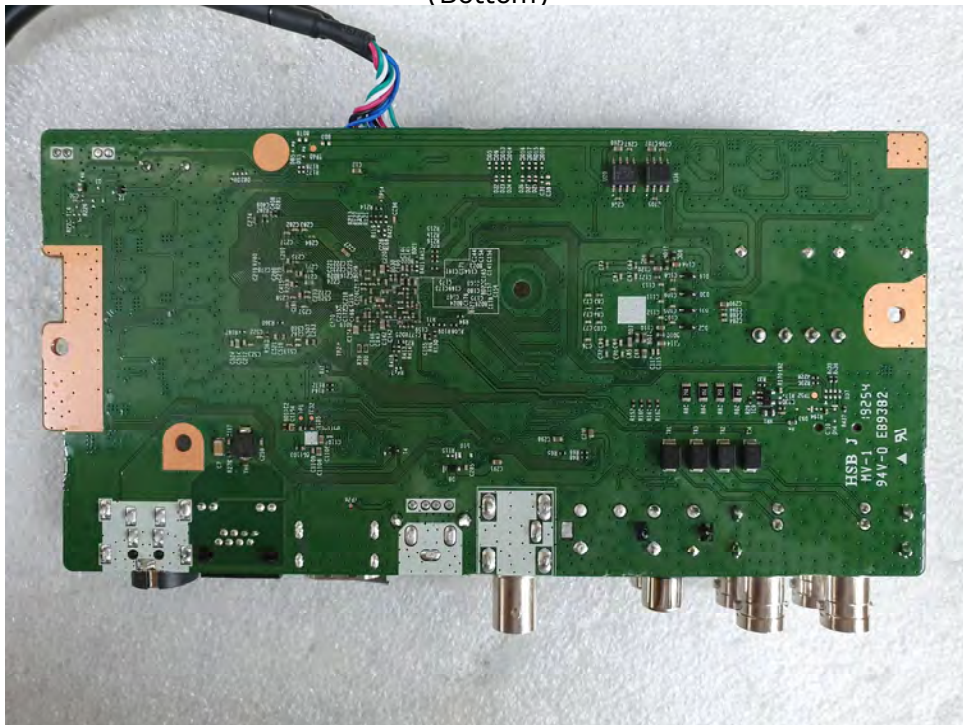

This report shall not be reproduced except in full, without the written approval of KES Co., Ltd.
The results shown in this test report refer only to the sample(s) tested unless otherwise stated.
The authenticity of the test report, contact shchoi@kes.co.kr

EUT Internal View – Sub Board 1

(Top)

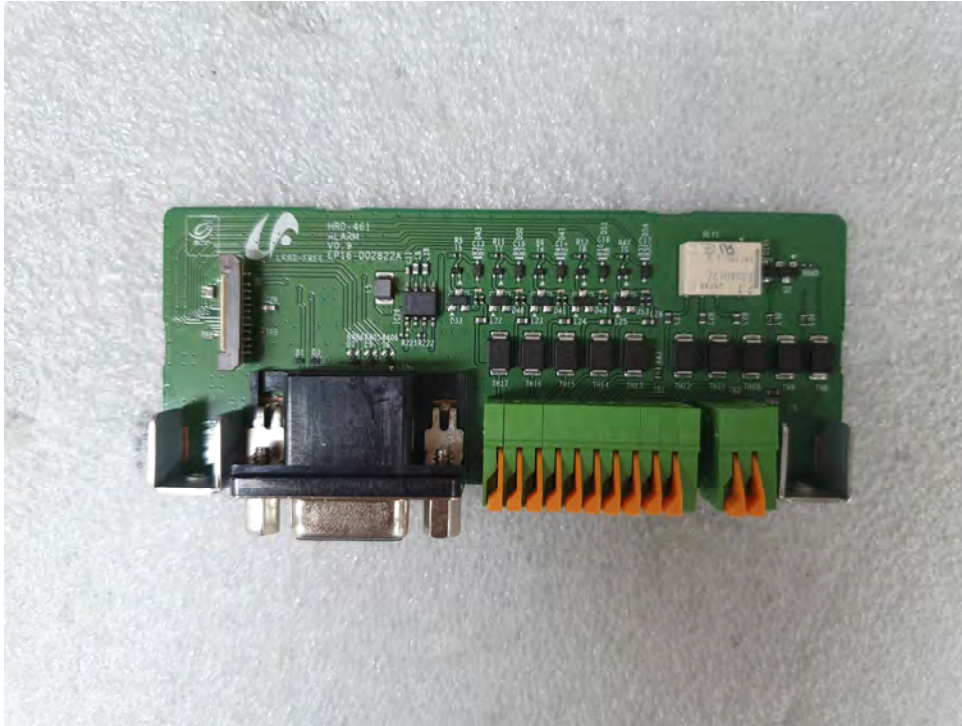

(Bottom)



This report shall not be reproduced except in full, without the written approval of KES Co., Ltd.
The results shown in this test report refer only to the sample(s) tested unless otherwise stated.
The authenticity of the test report, contact shchoi@kes.co.kr

EUT Internal View – Sub Board 2

(Top)

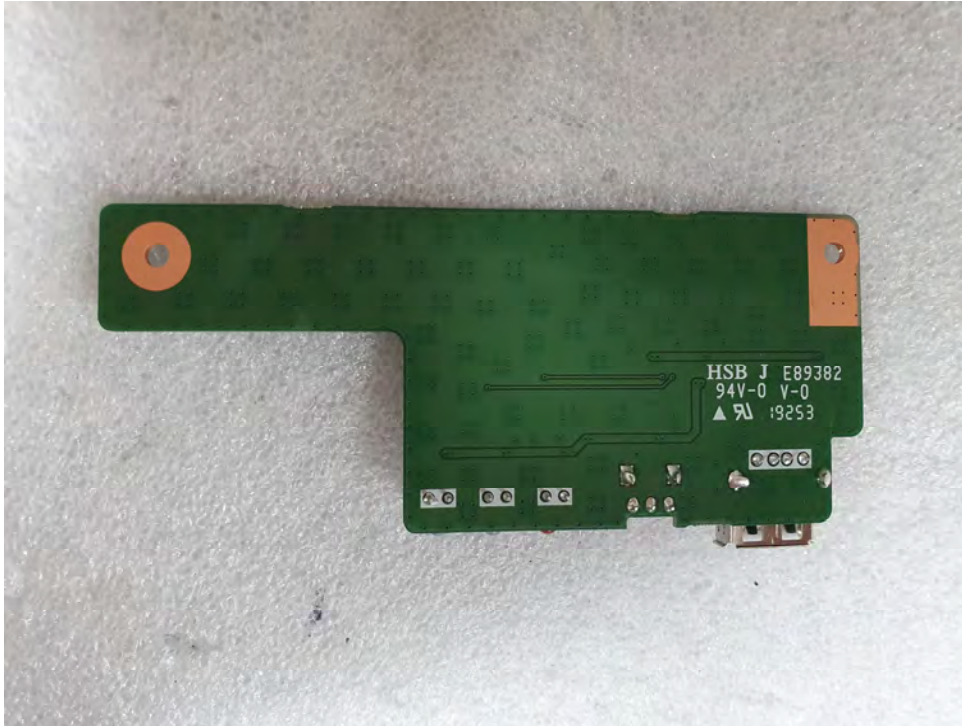

(Bottom)



This report shall not be reproduced except in full, without the written approval of KES Co., Ltd.
The results shown in this test report refer only to the sample(s) tested unless otherwise stated.
The authenticity of the test report, contact shchoi@kes.co.kr

Label and Location

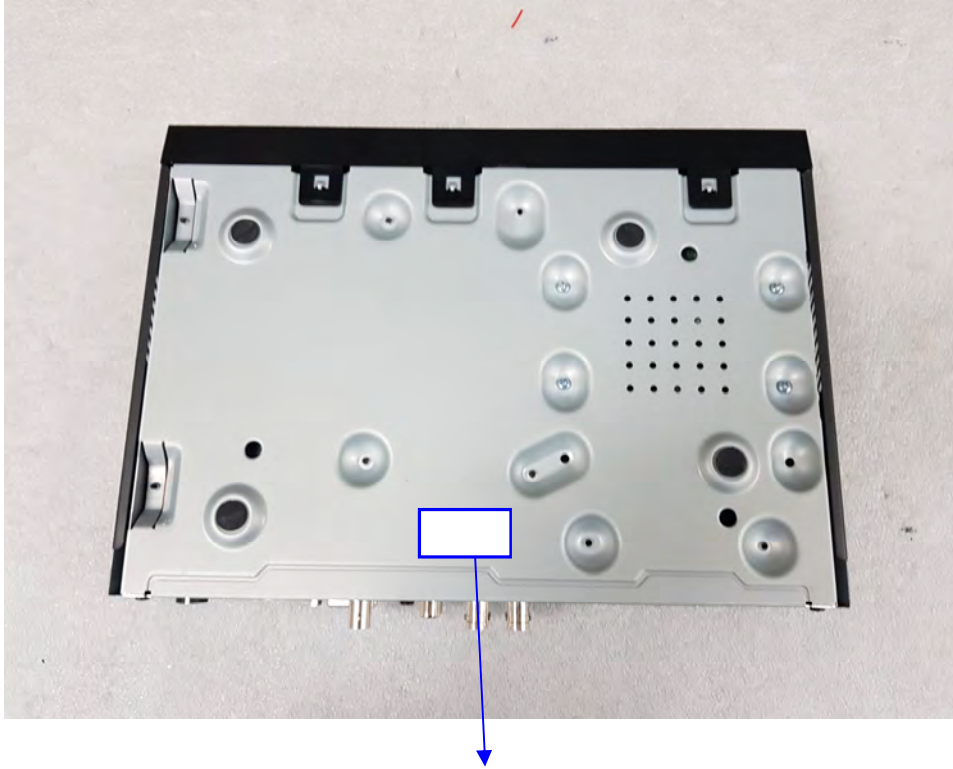

Pentabrid DVR (Digital Video Recorder)

Model No : HRX-420P

Manufacturer : HANWHA TECHWIN(TIANJIN) CO., LTD

Made in China

