

EMC TEST REPORT For CE

Test Report No. : KES-E1-18T0132-R1

Date of Issue : Jun. 25, 2018

Product name : Network Camera

Model/Type No. : XNV-6012M

Variant Model : -

Applicant : Hanwha Techwin Co., Ltd.

Applicant Address : 6, Pangyo-ro 319 Beon-gil, Bundang-gu, Seongnam-si,
Gyeonggi-do, 13488, KOREA

Manufacturer : 1. HANWHA TECHWIN(TIANJIN) CO., LTD
2. HANWHA TECHWIN SECURITY VIETNAM CO.,LTD.
3. D-TECH CO.,LTD.

Manufacturer Address : 1. No.11 Weiliu Rd, Micro-Electronic Industrial Park, TEDA, Tianjin,
300385, People's Republic of China
2. Lot O-2, Que Vo Industrial Zone extended area,
Nam Son commune, Bac Ninh city, Bac Ninh province, Vietnam
3. 173-25, Saneop-ro, Gwonseon-gu, Suwon-si, Gyeonggi- do,
Korea (Suwon Industrial Complex)

Date of Receipt : Jan. 24, 2018

Test date : Jan. 30, 2018 ~ Jan. 31, 2018

Test Results : **In Compliance** **Not in Compliance**

Tested by

Dong Il, Lee
EMC Test Engineer

Reviewed by

Dong-Hun, Jang
EMC Technical Manager

This test report is not related to KOLAS.



KES Co., Ltd.

3701, 40, Simin-daero 365beon-gil,
Dongan-gu, Anyang-si, Gyeonggi-do, 14057, Korea
Tel: +82-31-425-6200 / Fax: +82-31-424-0450
www.kes.co.kr

Test report No.:
KES-E1-18T0132-R1
Page (2) of (51)

REPORT REVISION HISTORY

Date	Test Report No.	Revision History
Feb. 07, 2018	KES-E1-18T0132	Issued
Jun. 25, 2018	KES-E1-18T0132-R1	Re-issue due to manufacturer change

This report shall not be reproduced except in full, without the written approval of KES Co., Ltd. This document Jun be altered or revised by KES Co., Ltd. personnel only, and shall be noted in the revision section of the document. Any alteration of this document not carried out by KES Co., Ltd. will constitute fraud and shall nullify the document.

This report shall not be reproduced except in full, without the written approval of KES Co., Ltd.
The results shown in this test report refer only to the sample(s) tested unless otherwise stated.



TABLE OF CONTENTS

1.0	General Product Description	4
1.1	Test Voltage & Frequency	7
1.2	Variant Model Differences.....	7
1.3	Device Modifications	7
1.4	Equipment Under Test.....	7
1.5	Support Equipments	7
1.6	External I/O Cabling	8
1.7	EUT Operating Mode(s)	8
1.8	Configuration.....	9
1.9	Remarks when standards applied	10
1.10	Calibration Details of Equipment Used for Measurement	10
1.11	Test Facility	10
1.12	Laboratory Accreditations and Listings	10
2.0	Test Regulations.....	10
2.1	Conducted Emissions at Mains Power Ports	13
2.2	Radiated Electric Field Emissions(Below 1 GHz)	14
2.3	Radiated Electric Field Emissions(Above 1 GHz).....	15
2.4	Harmonic Current Emissions	16
2.5	Voltage Fluctuations and Flicker	17
3.0	Criteria for compliance.....	18
3.1	Electrostatic Discharge.....	19
3.2	Radiated Electric Field Immunity	23
3.3	Electrical Fast Transients/Bursts	26
3.4	Surge Transients	28
3.5	Conducted Disturbance	31
APPENDIX A – TEST DATA.....		33
Conducted Emissions at Mains Power Ports.....		33
Radiated Electric Field Emissions(Below 1 GHz)		35
Radiated Electric Field Emissions(Above 1 GHz).....		36
Harmonic Current Emissions and Voltage Fluctuations and Flicker		37
Test Setup Photos and Configuration		40
Conducted Voltage Emissions		40
Radiated Electric Field Emissions(Below 1 GHz)		41
Radiated Electric Field Emissions(Above 1 GHz).....		42
Harmonic Current Emissions and Voltage Fluctuations and Flicker		43
Electrostatic Discharge		44
Radiated Electric Field Immunity		44
Electrical Fast Transients/Bursts		45
Surge Transients.....		45
Conducted Disturbance		46
EUT External Photographs		47
EUT Internal Photographs		48

1.0 General Product Description

Main Specifications of EUT are:

1/2.8" 2M CMOS
1945(H) x 1109(V) 2.16M
1945(H) x 1097(V) 2.13M
Progressive Scan
Color : 0.055 lux(F2.0, 1/30sec) (TBD)
B/W : 0.0055Lux
50dB
USB : Micro USB type B, 1280x720, for installation
2.4mm Fixed
F2.0
H 139° V 73° D167° (TBD)
0.4m(1.31ft)
Manual
Fixed
Board-in type
±5°/0-67°/±90°
-
Off / On (Displayed up to 85 characters) - WW : English/Numeric/Special Characters - China : English/Numeric/Special/Chinese Characters - Common : Multi-line (Max 5), Color (Grey/Green/Red/Blue/Black/White), Transparency, Auto Scale by Resolution
Auto (ICR) / Color / B/W / External / Schedule
Off / BLC / HLC(Masking/Dimming), WDR
150dB
SSDR (Off / On)
SSNR5 (2D+3D Noise Filter) (Off / On)
Off / On
Auto(input from fog detection) / Manual / Off
Off/ On(8ea, 8point Polygonal zones), Handover
Off / On (32ea, polygonal zones) - Color : Grey/Green/Red/Blue/Black/White - Mosaic
Off / Low / Middle / High
ATW / AWC / Manual / Indoor / Outdoor((included Mercury & Sodium)
level adjustment
On/Off (5 levels with Min/Max)
Minimum / Maximum / Anti flicker (2 ~ 1/12,000sec)
24X, 'Digital PTZ(Preset, Group)

This report shall not be reproduced except in full, without the written approval of KES Co., Ltd.
The results shown in this test report refer only to the sample(s) tested unless otherwise stated.



KES Co., Ltd.

3701, 40, Simin-daero 365beon-gil,
Dongan-gu, Anyang-si, Gyeonggi-do, 14057, Korea
Tel: +82-31-425-6200 / Fax: +82-31-424-0450
www.kes.co.kr

Test report No.:
KES-E1-18T0132-R1
Page (5) of (51)

Flip : On/Off Mirror : On/Off Hallway view : 90°/270°
Tampering, Loitering, Directional Detection, Defocus Detection, Fog Detection, Virtual Line, Enter/Exit, Appear / Disappear, Audio Detection, Face Detection, Motion Detection, Digital Auto Tracking, Sound Classification
-
Motion Detection, Video & Audio Analytics, Network Disconnect
File upload via FTP, E-Mail Notification via E-Mail local storage(SD/SDHC/SDXC) or NAS recording at Event Triggers External output DPTZ preset
Selectable (Mic IN/Line IN), Built-in microphone Supply voltage: 2.5VDC(4mA), Input impedance: approx. 2K Ohm
Line out, Max output level: 1 Vrms
Off / On
Support
M12 (10/100BASE-T)
H.265/H.264 (MPEG-4 Part 10/AVC) : Main/Baseline/High , Motion JPEG 1920x1080, 1280x1024, 1280x960, 1280x720, 1024x768, 800x600, 800x448, 720x576, 720x480, 640x480, 640x360, 320x240
H.265/H.264 : Max. 60fps at all resolutions Motion JPEG : Max. 30fps
Manual Mode (area-based : 5EA)
Support
H.264/H.265 : Target Bitrate Level Control MJPEG : Target Bitrate Level Control
H.264/H.265 : CBR or VBR MJPEG : VBR
Multiple Streaming (Up to 10 Profiles)
G.711 u-law /G.726 Selectable G.726 (ADPCM) 8KHz, G.711 8KHz G.726 : 16Kbps, 24Kbps, 32Kbps, 40Kbps AAC-LC : 48Kbps at 16KHz

This report shall not be reproduced except in full, without the written approval of KES Co., Ltd.
The results shown in this test report refer only to the sample(s) tested unless otherwise stated.



KES Co., Ltd.

3701, 40, Simin-daero 365beon-gil,
 Dongan-gu, Anyang-si, Gyeonggi-do, 14057, Korea
 Tel: +82-31-425-6200 / Fax: +82-31-424-0450
 www.kes.co.kr

Test report No.:
 KES-E1-18T0132-R1
 Page (6) of (51)

Bi-directional (2-Way)
IPv4, IPv6
TCP/IP, UDP/IP, RTP(UDP), RTP(TCP), RTCP,RTSP, NTP, HTTP, HTTPS, SSL/TLS, DHCP, PPPoE, FTP, SMTP, ICMP, IGMP, SNMPv1/v2c/v3(MIB-2), ARP, DNS, DDNS, QoS, PIM-SM, UPnP, Bonjour
HTTPS(SSL) Login Authentication Digest Login Authentication IP Address Filtering User access Log 802.1X Authentication (EAP-TLS, EAP-LEAP)
Unicast / Multicast
20 users at Unicast Mode
SD/SDHC/SDXC 1slot (up to 256 GB) - Motion Images recorded in the SD/SDHC/SDXC memory card can be downloaded. NAS(Network Attached Storage) Local PC for Instant Recording
ONVIF Profile S/G SUNAPI(HTTP API) Open Platform
English, Korean, Chinese, French, Italian, Spanish, German, Japanese, Russian, Swedish, Portuguese, Czech, Polish, Turkish, Dutch, Hungarian, Greek
Supported OS: Windows 7, 8.1, 10, Mac OS X 10.10, 10.11, 10.12 Non-plugin Webviewer Supported Browser: Google Chrome 54, MS Edge 38, Mozilla Firefox 49(Window 64bit only) , Apple Safari 9 (Mac OS X only) Plug-in Webviewer Supported Browser : MS Explore 11, Apple Safari 9 (Mac OS X only)
SmartViewer, SSM
-30°C ~ +55°C (-22°F ~ +131°F) / Less than 90% RH *Start up should be done at above -20°C
-50°C ~ +60°C (-22°F ~ +140°F) / Less than 90% RH
IP66
EN55011:2009+A1:2010, EN50581:2012,EN50121-3-2:2015, EN61000-4-2:2009 EN61000-4-3:2006+A2:2010, EN61000-4-4:2012, EN61000-4-5:2014 EN61000-4-6:2009, EN50155:2007, NEMA 4X
IK10, NEMA4X
PoE(IEEE802.3af,Class3)
TBD
Ivory / Metal
99 x 52 x 100
296g(TBD)

This report shall not be reproduced except in full, without the written approval of KES Co., Ltd.
 The results shown in this test report refer only to the sample(s) tested unless otherwise stated.



1.1 Test Voltage & Frequency

Unless indicated otherwise on the individual data sheet or test results, the test voltage and frequency was as indicated below.

Voltage 230Vac 100 Vac 24 Vac 12 Vdc PoE
Frequency 50 Hz 60 Hz Hz

1.2 Variant Model Differences

Not applicable

1.3 Device Modifications

Not applicable

1.4 Equipment Under Test

Description	Model Number	Serial Number	Manufacturer	Remarks
Network Camera	XNV-6012M	-	HANWHA TECHWIN (TIANJIN) CO., LTD	EUT

1.5 Support Equipments

Description	Model Number	Serial Number	Manufacturer	Remarks
PoE ADAPTER	GS728TPP	-	NETGEAR, INC.	-
Notebook	LG15N54	410NZGK015231	LG Electronics Inc.	-
AC/DC ADAPTER	ADP-90WH B	84ZW19F1663	DELTA ELECTRONICS (JIANGSU) LTD.	-
Mike	CMK-303	-	CAMAC	-
Micro SD Card	-	-	-	-
Speaker	BR10000A CUVE	-	BEIJING EDIFIER HI-TECH GROUP.	-

1.6 External I/O Cabling

■ PoE Mode

Start		END		Cable Spec.	
Description	I/O Port	Description	I/O Port	Length	Shield
Network Camera (EUT)	RJ-45	PoE ADAPTER	RJ-45	3.0	U
Network Camera (EUT)	RJ-45	Notebook	RJ-45	3.0	U
Network Camera (EUT)	3.5 Ø	Mike	3.5 Ø	1.7	U
Network Camera (EUT)	Micro SD Slot	Micro SD Card	Micro SD Slot	-	-
Network Camera (EUT)	3.5 Ø	Speaker	3.5 Ø	1.6	U

* Unshielded=U, Shielded=S

1.7 EUT Operating Mode(s)

Test mode	operating
PoE	EUT Monitoring, Ping test

EUT Test operating S/W		
Name	Version	Manufacture Company
Webviewer	-	Hanwha Techwin Co., Ltd.

This report shall not be reproduced except in full, without the written approval of KES Co., Ltd.
The results shown in this test report refer only to the sample(s) tested unless otherwise stated.

1.8 Configuration

- AC Main
- DC Main
- PoE Mode

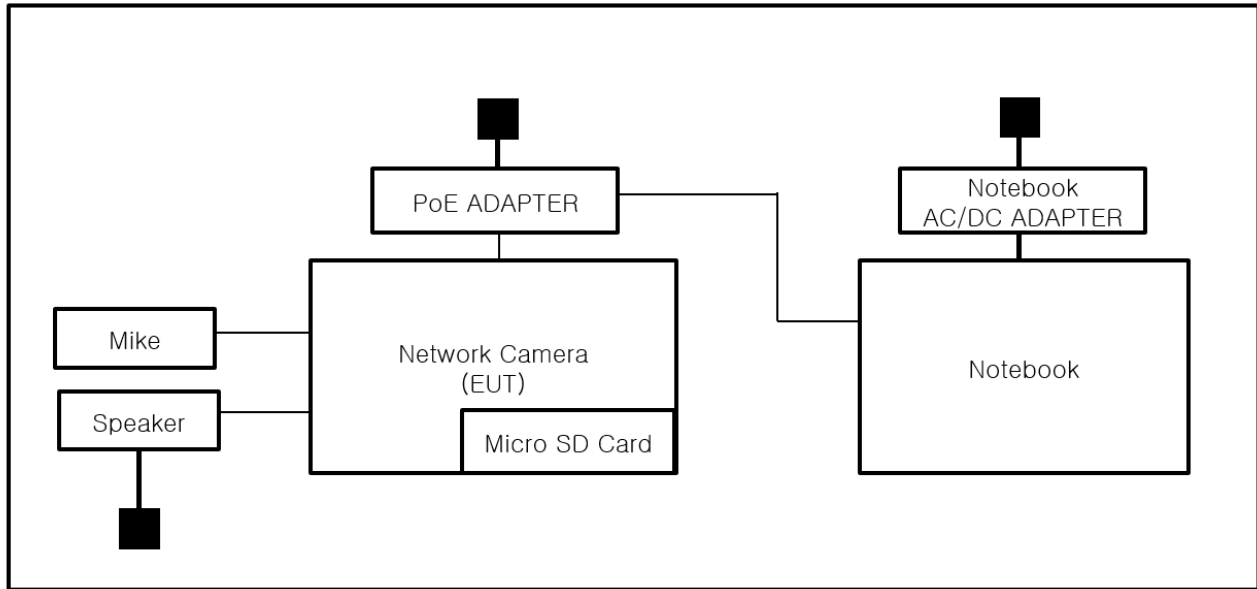

This report shall not be reproduced except in full, without the written approval of KES Co., Ltd.
The results shown in this test report refer only to the sample(s) tested unless otherwise stated.

1.9 Remarks when standards applied

- N/A







1.10 Calibration Details of Equipment Used for Measurement

Test equipment and test accessories are calibrated on regular basis. The maximum time between calibrations is one year or what is recommended by the manufacturer, whichever is less.

1.11 Test Facility

The measurement facility is located at 473-21 Gayeo-ro, Yeosu-si, Gyeonggi-do, 12658, Korea. The sites are constructed in conformance with the requirements of ANSI C63.4:2014 and CISPR 16-1-4:2012

1.12 Laboratory Accreditations and Listings

Country	Agency	Scope of Accreditation	Accreditation No
KOREA	RRA	EMI (3 m & 10 m Semi-Aechoic Chamber , 10 m Open Area and conducted test site) EMS (ESD, RS, EFT/Burst, Surge, CS, Magnetic, Dips and interruptions)	 KR0100
International	KOLAS	EMI (3 m & 10 m Semi-Aechoic Chamber , and conducted test site) EMS (ESD, RS, EFT/Burst, Surge, CS, Magnetic, Dips and interruptions)	 KT489
USA	FCC	3 m & 10 m Semi-Aechoic Chamber, 10 m Open Area and Conducted test site to perform FCC Part 15/18 measurements.	 KR0100
Canada	ISED	3 m & 10 m Semi-Aechoic Chamber and Conducted test site	 23298-1
JAPAN	VCCI	Mains Ports Conducted Interference Measurement, Telecommunication Ports Conducted Disturbance Measurement and Radiation 10 meter site, Facility for measuring radiated disturbance above 1 GHz	 R-4308, C-4798, T-2311, G-914
Europe	TÜV SÜD	EMI (3 m & 10 m Semi-Aechoic Chamber , 10 m Open Area and conducted test site) EMS (ESD, RS, EFT/Burst, Surge, CS, Magnetic, Dips and interruptions)	 CARAT 17 07 01633 001

This report shall not be reproduced except in full, without the written approval of KES Co., Ltd.
 The results shown in this test report refer only to the sample(s) tested unless otherwise stated.

2.0 Test Regulations

The emissions tests were performed according to following regulations:

EMC – Directive 2014/30/EU

EN 61000-6-3:2011

EN 61000-6-1:2007

EN 61000-6-4:2007 +A1:2011

EN 61000-6-2:2005

EN 55011:2009/A1:2010

Group 1

Group 2

Class A

Class B

EN 55014-1:2006 +A2:2011

EN 55014-2:1997 +A2:2008

EN 55015:2013

EN 61547:2009

EN 55032:2012/AC:2013

Class A

Class B

EN 55024:2010 +A1:2015

EN 50130-4:2011 +A1:2014

EN 61000-3-2:2014

EN 61000-3-3:2013

EN 61326-1:2013

EN 50121-3-2:2006/AC:2008



-
- | | | |
|---|----------------------------------|----------------------------------|
| <input type="checkbox"/> VCCI V-3 / 2015.04 | <input type="checkbox"/> Class A | <input type="checkbox"/> Class B |
| <input type="checkbox"/> AS/NZS CISPR22:2009 +A1:2010 | <input type="checkbox"/> Class A | <input type="checkbox"/> Class B |
| <input type="checkbox"/> 47 CFR Part 15, Subpart B | | |
| <input type="checkbox"/> CISPR 22:2009 +A1:2010 | <input type="checkbox"/> Class A | <input type="checkbox"/> Class B |
| <input type="checkbox"/> ANSI C63.4-2009 | | |
| <input type="checkbox"/> IC Regulation ICES-003 : 2016 | | |
| <input type="checkbox"/> CAN/CSA CISPR 22-10 | <input type="checkbox"/> Class A | <input type="checkbox"/> Class B |
| <input type="checkbox"/> ANSI C63.4-2014 | | |
| <input type="checkbox"/> RE- Directive 2014/53/EU | | |
| <input type="checkbox"/> EN 301 489-1 V1.9.2 | | |
| <input type="checkbox"/> Equipment for fixed use | | |
| <input type="checkbox"/> Equipment for vehicular use | | |
| <input type="checkbox"/> Equipment for portable use | | |
| <input type="checkbox"/> EN 301 489-3 V1.6.1 | | |
| <input type="checkbox"/> EN 301 489-17 V2.2.1 | | |
| <input type="checkbox"/> EN 60945:2002 | | |

This report shall not be reproduced except in full, without the written approval of KES Co., Ltd.
The results shown in this test report refer only to the sample(s) tested unless otherwise stated.

2.1 Conducted Emissions at Mains Power Ports

Test Date

N/A

Test Location

Electro wave Shieldroom

Test Equipment

Used	Description	Model Number	Manufacturer	Serial Number	Cal. Due
<input type="checkbox"/>	EMI Test S/W	EMC32	R & S	9.12.00	-
<input type="checkbox"/>	EMI TEST RECEIVER	ESR3	R & S	101781	04, 27, 2018
<input type="checkbox"/>	LISN	ENV216	R & S	101787	01, 05, 2019
<input type="checkbox"/>	LISN	ESH2-Z5	R & S	100450	04, 27, 2018
<input type="checkbox"/>	PULSE LIMITER	ESH3-Z2	R & S	101915	11, 27, 2018

Test Conditions

Temperature:

°C

Relative Humidity:

% R.H.

.

Frequency Range of Measurement

150 kHz to 30 MHz

Instrument Settings

IF Band Width: 9 kHz

Test Results

The requirements are:

- PASS
 NOT PASS
 NOT APPLICABLE

RemarksN/A : Because the EUT power is PoE, limits are not specified.

2.2 Radiated Electric Field Emissions(Below 1 GHz)

Test Date

Jan. 30, 2018

Test Location OPEN AREA TEST SITE #2 SEMI ANECHOIC CHAMBER #4(10 m)**Test Equipment**

Used	Description	Model Number	Manufacturer	Serial Number	Cal. Due
<input checked="" type="checkbox"/>	EMI Test S/W	EP5/RE	TOYO Corporation	6.0.0	-
<input checked="" type="checkbox"/>	EMI TEST RECEIVER	ESU26	R & S	100551	04, 18, 2018
<input checked="" type="checkbox"/>	AMPLIFIER	SCU 01	R & S	100603	11, 27, 2018
<input checked="" type="checkbox"/>	TRILOG-BROADBAND ANTENNA	VULB9163	Schwarzbeck	716	11, 28, 2018

Test ConditionsTemperature: 23,0 °C
Relative Humidity: 41,4 % R.H.**Frequency Range of Measurement**

30 MHz to 1 GHz

Instrument Settings

IF Band Width: 120 kHz

Test Results

The requirements are:

- PASS
 NOT PASS
 NOT APPLICABLE

RemarksSee Appendix A for test data.



2.3 Radiated Electric Field Emissions(Above 1 GHz)

Test Date

N/A

Test Location

SEMI ANECHOIC CHAMBER #2

Test Equipment

Used	Description	Model Number	Manufacturer	Serial Number	Cal. Due
<input type="checkbox"/>	EMI Test S/W	e3	AUDIX	8.083b	-
<input type="checkbox"/>	EMI TEST RECEIVER	ESU26	R & S	100552	04, 19, 2018
<input type="checkbox"/>	PREAMPLIFIER	8449B	AGILENT	3008A01729	01, 11, 2019
<input type="checkbox"/>	ATTENUATOR	8491A	HP	35496	03, 24, 2018
<input type="checkbox"/>	LOG-PERIODIC ANTENNA	STLP 9149	SCHWARZBECK	9149-255	05, 17, 2018

Test Conditions

Temperature:

°C

Relative Humidity:

% R.H.

Frequency Range of Measurement

1 GHz to 6 GHz

Instrument Settings

IF Band Width: 1 MHz

Test Results

The requirements are:

- PASS
- NOT PASS
- NOT APPLICABLE

Remarks

N/A

3.0 Criteria for compliance

Criteria for compliance was based on the following guidelines:

General performance criteria

The general principles (performance criteria) for the evaluation of the immunity test results are the following.

Performance criterion A

The apparatus shall continue to operate as intended during and after the test. No degradation of performance or loss of function is allowed below a performance level specified by the manufacturer, when the apparatus is used as intended. The performance level may be replaced by a permissible loss of performance. If the minimum performance level or the permissible performance loss is not specified by the manufacturer, either of these may be derived from the product description and documentation and what the user may reasonably expect from the apparatus if used as intended.

Performance criterion B

The apparatus shall continue to operate as intended after the test. No degradation of performance or loss of function is allowed below a performance level specified by the manufacturer, when the apparatus is used as intended. The performance level may be replaced by a permissible loss of performance. During the test, degradation of performance is however allowed. No change of actual operating state or stored data is allowed. If the minimum performance level or the permissible performance loss is not specified by the manufacturer, either of these may be derived from the product description and documentation and what the user may reasonably expect from the apparatus if used as intended.

Performance criterion C

Temporary loss of function is allowed, provided the function is self-recoverable or can be restored by the operation of the controls.



3.1 Electrostatic Discharge

Reference Standard

EN 61000-4-2:2009

Test Date

Jan. 30, 2018

Test Location

EMS-ESD: Electro wave Shieldroom #7

Test Equipment

Used	Description	Model Number	Manufacturer	Serial Number	Cal. Due
<input checked="" type="checkbox"/>	ESD SIMULATOR	ESS-2000	Noise Ken	ESS01Z0454	-
<input checked="" type="checkbox"/>	HCP	-	KES	-	10, 11, 2018
<input checked="" type="checkbox"/>	VCP	-	KES	-	-

Test Conditions

Temperature: 23,5 °C
Relative Humidity: 42,1 % R.H.
Atmospheric Pressure: 101,4 kPa



KES Co., Ltd.

3701, 40, Simin-daero 365beon-gil,
Dongan-gu, Anyang-si, Gyeonggi-do, 14057, Korea
Tel: +82-31-425-6200 / Fax: +82-31-424-0450
www.kes.co.kr

Test report No.:
KES-E1-18T0132-R1
Page (20) of (51)

Test Specifications

Discharge Factor: ≥ 1 s

Discharge Impedance: 330 ohm / 150 pF

Kind of Discharge: Air, Contact (direct and indirect)

Polarity: Positive and Negative

Number of Discharge: 10 at all locations for Air discharge
10 at all locations for Contact discharge

Discharge Voltage:	Contact	Air	HCP	VCP
	<input checked="" type="checkbox"/> 2 kV	<input checked="" type="checkbox"/> 2 kV	<input type="checkbox"/> 2 kV	<input type="checkbox"/> 2 kV
	<input checked="" type="checkbox"/> 4 kV	<input checked="" type="checkbox"/> 4 kV	<input type="checkbox"/> 4 kV	<input type="checkbox"/> 4 kV
	<input checked="" type="checkbox"/> 6 kV	<input type="checkbox"/> 6 kV	<input checked="" type="checkbox"/> 6 kV	<input checked="" type="checkbox"/> 6 kV
	<input type="checkbox"/> 8 kV	<input checked="" type="checkbox"/> 8 kV	<input type="checkbox"/> 8 kV	<input type="checkbox"/> 8 kV
	<input type="checkbox"/> 15 kV	<input type="checkbox"/> 15 kV	<input type="checkbox"/> 15 kV	<input type="checkbox"/> 15 kV

Notes: HCP: Horizontal coupling plane

VCP: Vertical coupling plane

Required Performance Criteria: B

This report shall not be reproduced except in full, without the written approval of KES Co., Ltd.
The results shown in this test report refer only to the sample(s) tested unless otherwise stated.

Location of Discharge:

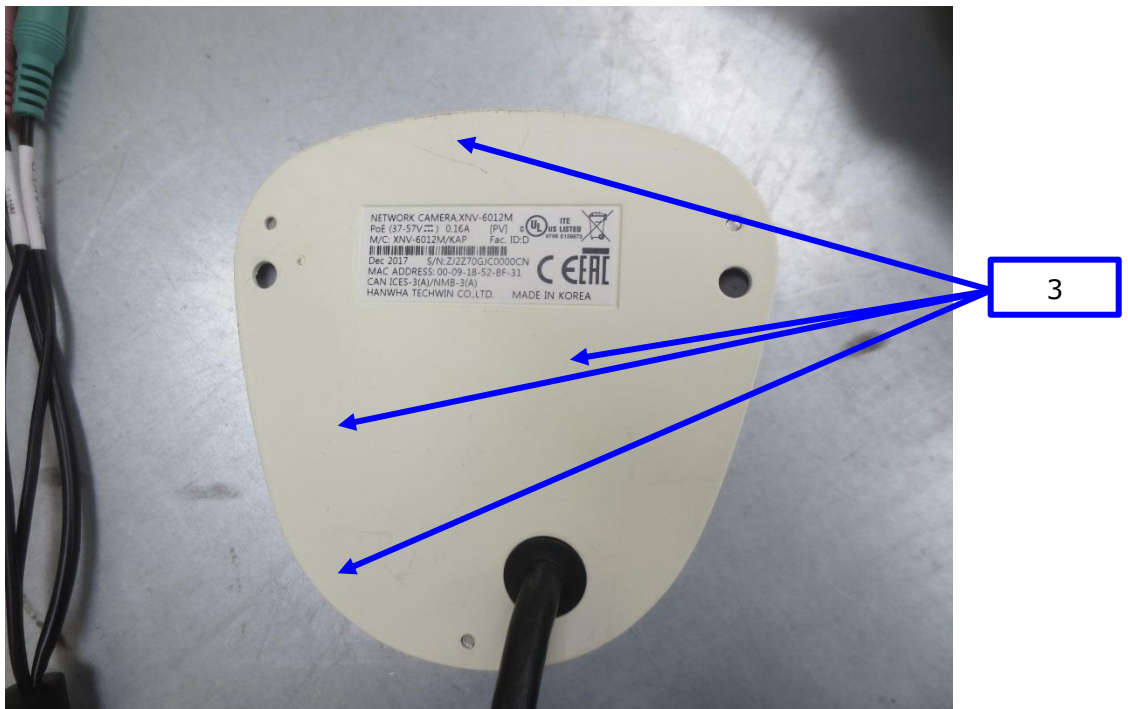
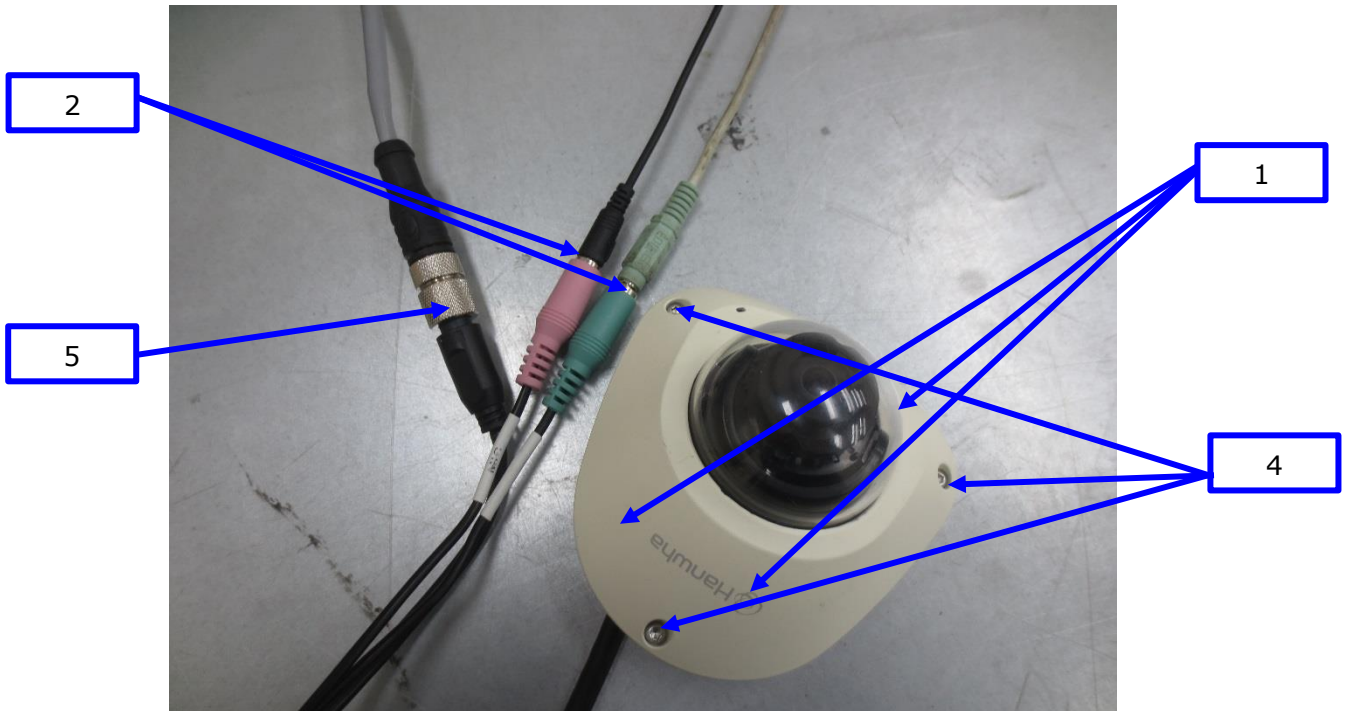
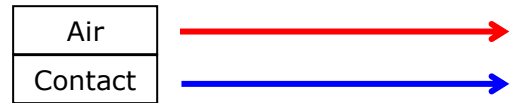

This report shall not be reproduced except in full, without the written approval of KES Co., Ltd.
 The results shown in this test report refer only to the sample(s) tested unless otherwise stated.



Test Data

Indirect Discharge

No.	Test Point	Discharge Method	Observations	Remarks
1	HCP Contact	Contact Discharge	A	-
2	VCP Contact	Contact Discharge	A	-

Direct Discharge

No.	Test Point	Discharge Method	Observations	Remarks
1	Surface	Contact Discharge	A	-
2	3.5 Ø	Contact Discharge	A	-
3	Surface	Contact Discharge	A	-
4	screw	Contact Discharge	A	-
5	port	Contact Discharge	A	-

Note: "Blank" = Not performed

Observations:
Complied – No degradation of function

Test Results

- PASS Required Performance Criteria
- NOT PASS Required Performance Criteria

Remarks

PASS Required Performance Criteria.



3.2 Radiated Electric Field Immunity

Reference Standard

EN 61000-4-3:2006 +A2:2010

Test Date

Jan. 30, 2018

Test Location

EMS-RS: SEMI ANECHOIC CHAMBER #3 SEMI ANECHOIC CHAMBER #4

Test Equipment

Used	Description	Model Number	Manufacturer	Serial Number	Cal. Due
<input checked="" type="checkbox"/>	EMS Test S/W	EMC32	R & S	10.10.02	-
<input checked="" type="checkbox"/>	SIGNAL GENERATOR	SMB 100A	R & S	177586	08, 07, 2018
<input checked="" type="checkbox"/>	BROADBAND AMPLIFIER	BBA100	R & S	101239	08, 07, 2018
<input checked="" type="checkbox"/>	BROADBAND AMPLIFIER	100S1G6M1	AR	579931	08, 07, 2018
<input checked="" type="checkbox"/>	POWER METER	NRP2	R & S	103475	08, 07, 2018
<input checked="" type="checkbox"/>	AVG POWER SENSOR	NRP-Z91	R & S	102526	08, 07, 2018
<input checked="" type="checkbox"/>	AVG POWER SENSOR	NRP-Z91	R & S	102527	08, 07, 2018
<input checked="" type="checkbox"/>	STACKED DOUBLE LOG-PER- ANTENNA	STPL9128 E	Schwarzbeck	9128ES-121	-
<input checked="" type="checkbox"/>	DIRECTIONAL COUPLER	KYDC-D1070-DX40	KY TELECOM	KY150001	08, 07, 2018
<input checked="" type="checkbox"/>	DOUBLE RIDGED HORN ANTENNA	SAS-571	A.H.SYSTEM,IN C	781	05, 02, 2019
<input checked="" type="checkbox"/>	SIGNAL GENERATOR	SMB 100A	Rohde & Schwarz	108252	08, 07, 2018
<input checked="" type="checkbox"/>	HIGH POWER DUAL AMP	SSA532	성산전자	SSA532-001	05, 18, 2018
<input checked="" type="checkbox"/>	POWER METER	E4419B	Agilent	GB40203000	06, 26, 2018
<input checked="" type="checkbox"/>	CW POWER SENSOR	E4412A	Agilent	US38488240	06, 26, 2018
<input checked="" type="checkbox"/>	CW POWER SENSOR	E4412A	Agilent	MY41501662	06, 26, 2018

This report shall not be reproduced except in full, without the written approval of KES Co., Ltd.
The results shown in this test report refer only to the sample(s) tested unless otherwise stated.



Test Conditions

Temperature: 23,2 °C
Relative Humidity: 41,5 % R.H.
Atmospheric Pressure: 101,4 kPa

Test Specifications

Antenna Polarization: Horizontal & vertical unless indicated otherwise

Antenna Distance: 3 m

Frequency Range: 80 MHz to 1 GHz [20V/m]
[Field Strength] 800 MHz to 1 GHz [20 V/m]
 1,4 GHz to 2,1 GHz [10 V/m]
 2,1 GHz to 2,5 GHz [5 V/m]

Modulation: AM, 80 %, 1 kHz sine wave
 PM, 1 Hz (0,5 s ON : 0,5 s OFF)

Frequency step: 1 % step

Dwell Time: 1 s 3 s

of Sides Radiated: 4

Required Performance Criteria: A



KES Co., Ltd.

3701, 40, Simin-daero 365beon-gil,
Dongan-gu, Anyang-si, Gyeonggi-do, 14057, Korea
Tel: +82-31-425-6200 / Fax: +82-31-424-0450
www.kes.co.kr

Test report No.:
KES-E1-18T0132-R1
Page (25) of (51)

Test Data

Side Exposed	Observations	
	Horizontal	Vertical
Front	A	A
Right	A	A
Back	A	A
Left	A	A

Note: "Blank" = Not performed

Observations:
Complied – No degradation of function

Test Results

- PASS Required Performance Criteria
- NOT PASS Required Performance Criteria

Remarks

PASS Required Performance Criteria.

This report shall not be reproduced except in full, without the written approval of KES Co., Ltd.
The results shown in this test report refer only to the sample(s) tested unless otherwise stated.

3.3 Electrical Fast Transients/Bursts

Reference Standard

EN 61000-4-4:2012

Test Date

Jan. 30, 2018

Test Location

EMS-EFT: Electro wave Shieldroom #7

Test Equipment

Used	Description	Model Number	Manufacturer	Serial Number	Cal. Due
<input checked="" type="checkbox"/>	EMS Test S/W	iec.control	EM TEST	5.4.7	-
<input checked="" type="checkbox"/>	ULTRA COMPACT SIMULATOR	UCS 500N7	EM TEST	P1608172950	11, 27, 2018
<input checked="" type="checkbox"/>	MOTOR VARIAC	MV2616	EM TEST	P1552169719	11, 27, 2018
<input checked="" type="checkbox"/>	CAPACITIVE COUPLING CLAMP	HFK	EM TEST	P1633183115	11, 27, 2018

Test Conditions

Temperature: 23,5 °C
Relative Humidity: 42,1 % R.H.
Atmospheric Pressure: 101,4 kPa

Test Specifications

Pulse Amplitude & Polarity: ± 1.0 kV ± 2.0 kV
(AC Power Lines) ± 4.0 kV

Pulse Amplitude & Polarity: ± 0.5 kV ± 1.0 kV
(Other supply / Signal Lines) ± 2.0 kV

Burst Period: 300 ms 2 s

Repetition Rate: 5 kHz 100 kHz

Duration of Test Voltage: ≥ 1 min

Required Performance Criteria: A

This report shall not be reproduced except in full, without the written approval of KES Co., Ltd.
The results shown in this test report refer only to the sample(s) tested unless otherwise stated.



Test Data

Input a.c. power ports – Coupling/Decoupling Network used

Mode of Application	Observations	
	(+) Burst (kV)	(-) Burst (kV)
-	-	-

Input d.c. power ports – Coupling/Decoupling Network used

Mode of Application	Observations	
	(+) Burst (kV)	(-) Burst (kV)
-	-	-

Signal ports and telecommunication ports – Coupling Clamp used

Mode of Application	Observations	
	(+) Burst (kV)	(-) Burst (kV)
RJ-45	A	A

Note: “Blank” = Not performed

Observations:

Complied – No degradation of function

Test Results

- PASS Required Performance Criteria
- NOT PASS Required Performance Criteria

Remarks

PASS Required Performance Criteria.



3.4 Surge Transients

Reference Standard

EN 61000-4-5:2014

Test Date

N/A

Test Location

EMS-Surge: Electro wave Shieldroom #7

Test Equipment

Used	Description	Model Number	Manufacturer	Serial Number	Cal. Due
<input type="checkbox"/>	EMS Test S/W	iec.control	EM TEST	5.4.7	-
<input type="checkbox"/>	ULTRA COMPACT SIMULATOR	UCS 500N7	EM TEST	P1608172950	11, 27, 2018
<input type="checkbox"/>	MOTOR VARIAC	MV2616	EM TEST	P1552169719	11, 27, 2018
<input type="checkbox"/>	CDN	CNV 508N1	EM TEST	P1610176296	11, 28, 2018
<input type="checkbox"/>	CDN	CNV 504N7.3	EM TEST	P1744207079	12, 18, 2018

Test Conditions

Temperature: °C
Relative Humidity: % R.H.
Atmospheric Pressure: kPa

This report shall not be reproduced except in full, without the written approval of KES Co., Ltd.
The results shown in this test report refer only to the sample(s) tested unless otherwise stated.



Test Specifications

AC Power Lines

- Source Impedance: 42 ohm for common mode
- Surge Amplitude : Common Mode
 2 kV
Differential Mode
 1 kV
- Number of Surges: 5 surges per angle
- Angle: 0°, 90°, 180°, 270° (input a.c. DC power port)
- Polarity: Positive & Negative
- Repetition Rate: 1 surge per min 1 surge per 30 sec.
- Required Performance Criteria: B

Other supply

- Source Impedance: 42 ohm for common mode
- Surge Amplitude: Common Mode
 2 kV
Differential Mode
 1 kV
- Number of Surges: 5 Surges
- Polarity: Positive & Negative
- Repetition Rate: 1 surge per min 1 surge per 30 sec.
- Required Performance Criteria: B



Test Data

Line to Earth – Differential Mode

Mode of Application	Observations	
	(+) Surge (kV)	(-) Surge (kV)
-	-	-

Line to Ground – Common Mode

Mode of Application	Observations	
	(+) Surge (kV)	(-) Surge (kV)
-	-	-
-	-	-

Note: "Blank" = Not performed
Observations: N/A

Test Results

- PASS Required Performance Criteria
- NOT PASS Required Performance Criteria

Remarks

N/A : Because the EUT power is PoE, limits are not specified.

3.5 Conducted Disturbance

Reference Standard

EN 61000-4-6:2014

Test Date

Jan. 31, 2018

Test Location

EMS-CS: Electro wave Shieldroom #6

Test Equipment

Used	Description	Model Number	Manufacturer	Serial Number	Cal. Due
<input checked="" type="checkbox"/>	EMS Test S/W	icd.control	EM TEST	5.3.11	-
<input checked="" type="checkbox"/>	CONTINUOUS WAVE SIMULATOR	CWS 500N1.4	EM TEST	P1602169880	11, 27, 2018
<input checked="" type="checkbox"/>	ATTENUATOR	ATT 6/80	EM TEST	P1614178148	11, 27, 2018
<input checked="" type="checkbox"/>	CDN	CDN M016	TESEQ	43694	11, 27, 2018
<input type="checkbox"/>	CDN	CDN M016	TESEQ	43697	11, 27, 2018
<input checked="" type="checkbox"/>	CDN	CDN T800	TESEQ	42800	11, 27, 2018
<input type="checkbox"/>	EM CLAMP	KEMZ 801A	TESEQ	44099	11, 28, 2018

Test Conditions

Temperature: 23,5 °C
Relative Humidity: 42,2 % R.H.
Atmospheric Pressure: 101,5 kPa

Test Specifications

Frequency range: 150 kHz to 100 MHz 150 kHz to 80 MHz

Voltage Level: 1 Vrms 3 Vrms
 10 Vrms

Modulation: AM, 80 %, 1 kHz sine wave

Frequency step: 1 % step

Dwell Time: 1 s 3 s

Required Performance Criteria: A

This report shall not be reproduced except in full, without the written approval of KES Co., Ltd.
The results shown in this test report refer only to the sample(s) tested unless otherwise stated.



Test Data

Input a.c. power ports

Coupling Location (Line Stressed)	Coupling Method	Observations
-	CDN (<input type="checkbox"/> M2, <input type="checkbox"/> M3)	-

Input d.c. power ports

Coupling Location (Line Stressed)	Coupling Method	Observations
-	CDN (<input type="checkbox"/> M2, <input type="checkbox"/> M3)	-

Signal ports and telecommunication ports

Coupling Location (Line Stressed)	Coupling Method	Observations
RJ-45	CDN T800	A

Notes: CDN = Coupling Decoupling Network
"blank" = Not performed

Observations:
Complied – No degradation of function

Test Results

- PASS Required Performance Criteria
- NOT PASS Required Performance Criteria

Remarks

PASS Required Performance Criteria.



KES Co., Ltd.

3701, 40, Simin-daero 365beon-gil,
Dongan-gu, Anyang-si, Gyeonggi-do, 14057, Korea
Tel: +82-31-425-6200 / Fax: +82-31-424-0450
www.kes.co.kr

Test report No.:
KES-E1-18T0132-R1
Page (33) of (51)

APPENDIX A – TEST DATA

Conducted Emissions at Mains Power Ports

[HOT]

N/A

This report shall not be reproduced except in full, without the written approval of KES Co., Ltd.
The results shown in this test report refer only to the sample(s) tested unless otherwise stated.



KES Co., Ltd.

3701, 40, Simin-daero 365beon-gil,
Dongan-gu, Anyang-si, Gyeonggi-do, 14057, Korea
Tel: +82-31-425-6200 / Fax: +82-31-424-0450
www.kes.co.kr

Test report No.:
KES-E1-18T0132-R1
Page (34) of (51)

[NEUTRAL]

N/A

◆ Calculation

QuasiPeak[dBuV] / CAverage [dBuV] = Reading Value[dBuV] + Corr. [dB]

QuasiPeak / CAverage : The Final Value

Reading Value : Not shown in the table.

Corr. : Correction values (LISN FACTOR + (Cable Loss + Pulse Limiter FACTOR))

This report shall not be reproduced except in full, without the written approval of KES Co., Ltd.
The results shown in this test report refer only to the sample(s) tested unless otherwise stated.

Radiated Electric Field Emissions(Below 1 GHz)

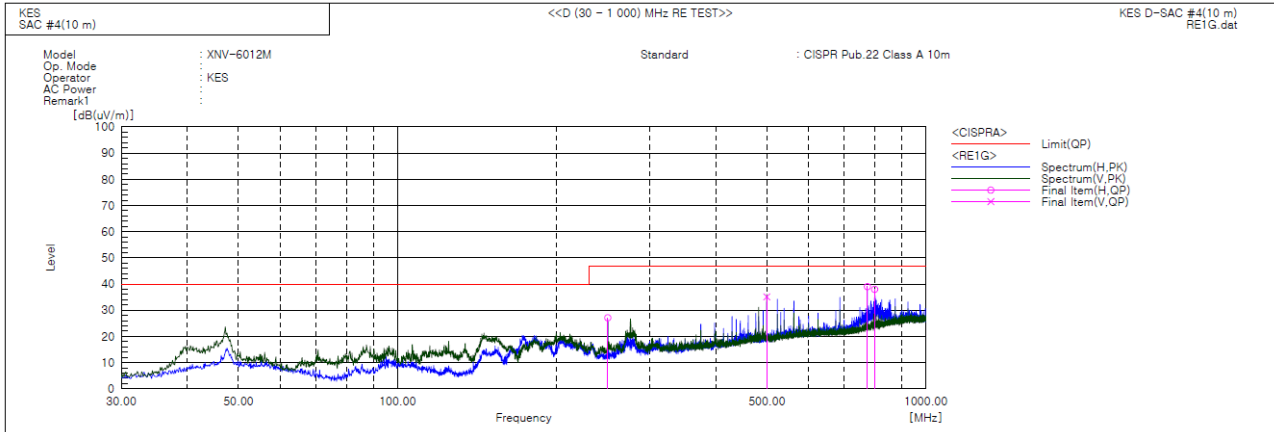

Final Result

No.	Frequency [MHz]	(P)	Reading QP [dB(uV)]	c.f [dB(1/m)]	Result QP [dB(uV/m)]	Limit QP [dB(uV/m)]	Margin QP [dB]	Height [cm]	Angle [deg]	Remark
1	250.014	H	53.3	-26.2	27.1	47.0	19.9	350.0	19.0	
2	500.009	V	53.9	-18.8	35.1	47.0	11.9	100.0	196.0	
3	774.997	H	53.3	-14.3	39.0	47.0	8.0	114.0	185.0	
4	800.005	H	52.0	-14.0	38.0	47.0	9.0	128.0	62.0	

◆ Calculation – SAC #4(10 m)

$$\text{Result(QP)} [\text{dB}(\mu\text{V}/\text{m})] = (\text{Reading(QP)}[\text{dB}(\mu\text{V})] + \text{c.f}[\text{dB}(1/\text{m})])$$

$$\text{Margin(QP)}[\text{dB}] = \text{Limit}[\text{dB}(\mu\text{V}/\text{m})] - \text{Result(QP)} [\text{dB}(\mu\text{V}/\text{m})]$$

Reading(QP) : Reading value, Result(QP) : Reading value + Factor value

Limit(QP) : Limit value, c.f : (ANT Factor + Cable Loss - Preamp Factor), Margin: Margin value

This report shall not be reproduced except in full, without the written approval of KES Co., Ltd.
 The results shown in this test report refer only to the sample(s) tested unless otherwise stated.



KES Co., Ltd.

3701, 40, Simin-daero 365beon-gil,
Dongan-gu, Anyang-si, Gyeonggi-do, 14057, Korea
Tel: +82-31-425-6200 / Fax: +82-31-424-0450
www.kes.co.kr

Test report No.:
KES-E1-18T0132-R1
Page (36) of (51)

Radiated Electric Field Emissions(Above 1 GHz)

N/A

◆ Calculation

Over Limit [dB] = (Read Level[dB μ V] + Ant Factor[dB/m] + Cable Loss [dB] – Preamp Factor [dB])
– Limit Line[dB μ V]

Over Limit : Margin, Read Level : Reading value, Ant Factor : ANT Factor,
Cable Loss : Cable loss, Preamp Factor : Preamp Factor

This report shall not be reproduced except in full, without the written approval of KES Co., Ltd.
The results shown in this test report refer only to the sample(s) tested unless otherwise stated.



Harmonic Current Emissions and Voltage Fluctuations and Flicker

Average harmonic current results

Hn	I _{eff} [A]	% of Limit	Limit [A]	Result
		N/A		

Harmonic currents less than 0.6% of the input current measured under the test conditions, or less than 5 mA, whichever is greater, are disregarded.

This report shall not be reproduced except in full, without the written approval of KES Co., Ltd.
The results shown in this test report refer only to the sample(s) tested unless otherwise stated.



KES Co., Ltd.

3701, 40, Simin-daero 365beon-gil,
Dongan-gu, Anyang-si, Gyeonggi-do, 14057, Korea
Tel: +82-31-425-6200 / Fax: +82-31-424-0450
www.kes.co.kr

Test report No.:
KES-E1-18T0132-R1
Page (38) of (51)

Test Data - Harmonics (continued)

Maximum harmonic current results				
Hn	I _{eff} [A]	% of Limit	Limit [A]	Result
		N/A		

Harmonic currents less than 0.6% of the input current measured under the test conditions, or less than 5 mA, whichever is greater, are disregarded.

This report shall not be reproduced except in full, without the written approval of KES Co., Ltd.
The results shown in this test report refer only to the sample(s) tested unless otherwise stated.



Test Data - Voltage Fluctuations

Maximum Flicker results

	EUT values	Limit	Result
Pst	N/A		
Plt			
dc [%]			
dmax [%]			
Tmax [s]			

This report shall not be reproduced except in full, without the written approval of KES Co., Ltd.
The results shown in this test report refer only to the sample(s) tested unless otherwise stated.



KES Co., Ltd.

3701, 40, Simin-daero 365beon-gil,
Dongan-gu, Anyang-si, Gyeonggi-do, 14057, Korea
Tel: +82-31-425-6200 / Fax: +82-31-424-0450
www.kes.co.kr

Test report No.:
KES-E1-18T0132-R1
Page (40) of (51)

Test Setup Photos and Configuration

Conducted Voltage Emissions

N/A

N/A

This report shall not be reproduced except in full, without the written approval of KES Co., Ltd.
The results shown in this test report refer only to the sample(s) tested unless otherwise stated.

Radiated Electric Field Emissions(Below 1 GHz)

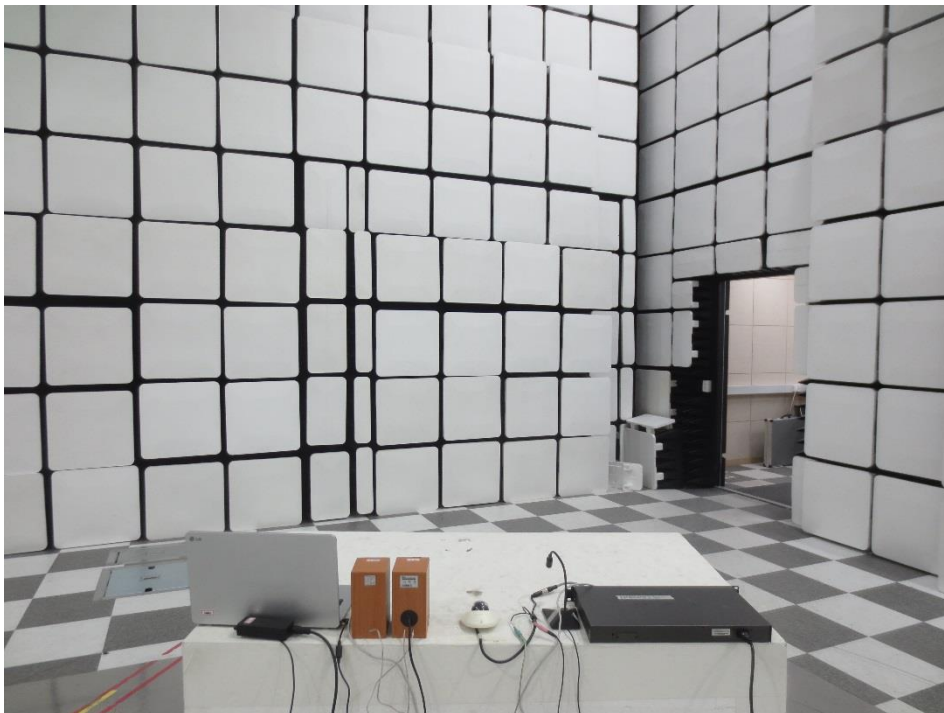
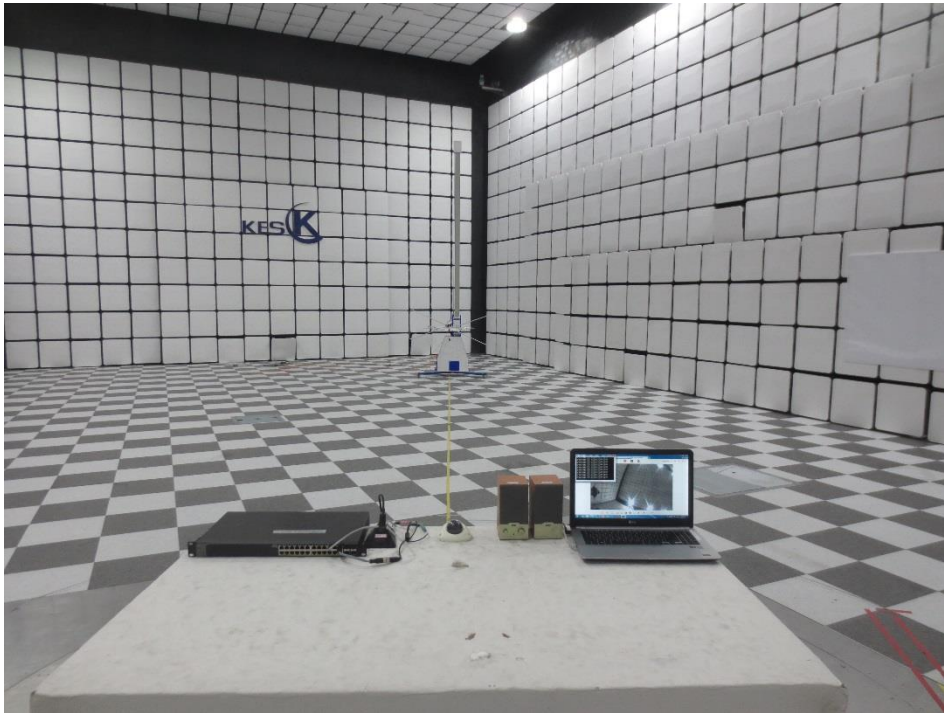

This report shall not be reproduced except in full, without the written approval of KES Co., Ltd.
The results shown in this test report refer only to the sample(s) tested unless otherwise stated.



KES Co., Ltd.

3701, 40, Simin-daero 365beon-gil,
Dongan-gu, Anyang-si, Gyeonggi-do, 14057, Korea
Tel: +82-31-425-6200 / Fax: +82-31-424-0450
www.kes.co.kr

Test report No.:
KES-E1-18T0132-R1
Page (42) of (51)

Radiated Electric Field Emissions(Above 1 GHz)

N/A

N/A

This report shall not be reproduced except in full, without the written approval of KES Co., Ltd.
The results shown in this test report refer only to the sample(s) tested unless otherwise stated.



KES Co., Ltd.

3701, 40, Simin-daero 365beon-gil,
Dongan-gu, Anyang-si, Gyeonggi-do, 14057, Korea
Tel: +82-31-425-6200 / Fax: +82-31-424-0450
www.kes.co.kr

Test report No.:
KES-E1-18T0132-R1
Page (43) of (51)

Harmonic Current Emissions and Voltage Fluctuations and Flicker

N/A

This report shall not be reproduced except in full, without the written approval of KES Co., Ltd.
The results shown in this test report refer only to the sample(s) tested unless otherwise stated.

Electrostatic Discharge

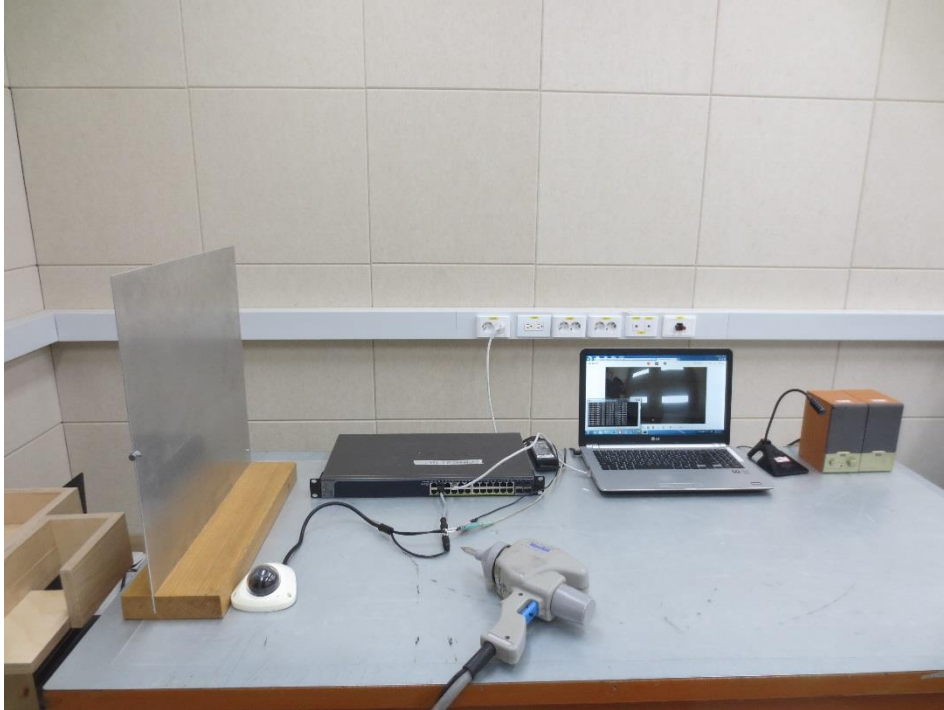

Radiated Electric Field Immunity



This report shall not be reproduced except in full, without the written approval of KES Co., Ltd.
The results shown in this test report refer only to the sample(s) tested unless otherwise stated.

Electrical Fast Transients/Bursts



Surge Transients

N/A

This report shall not be reproduced except in full, without the written approval of KES Co., Ltd.
The results shown in this test report refer only to the sample(s) tested unless otherwise stated.

Conducted Disturbance

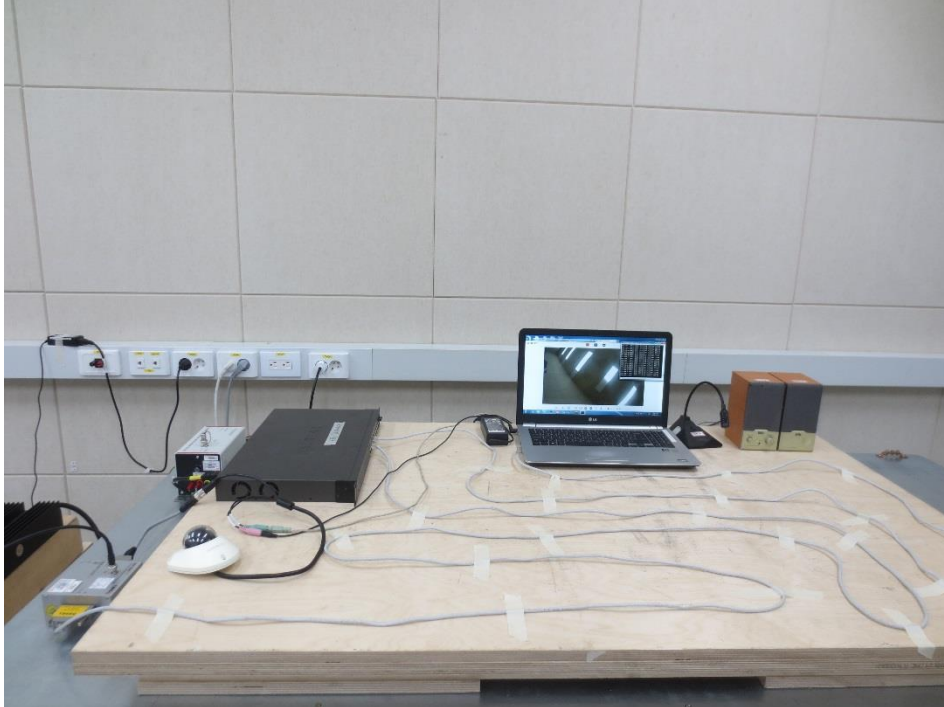

This report shall not be reproduced except in full, without the written approval of KES Co., Ltd.
The results shown in this test report refer only to the sample(s) tested unless otherwise stated.

EUT External Photographs

(Top)



(Bottom)



This report shall not be reproduced except in full, without the written approval of KES Co., Ltd.
The results shown in this test report refer only to the sample(s) tested unless otherwise stated.

EUT Internal Photographs

(Internal View)



This report shall not be reproduced except in full, without the written approval of KES Co., Ltd.
The results shown in this test report refer only to the sample(s) tested unless otherwise stated.

EUT Internal View – Main board

(Top)



(Bottom)



This report shall not be reproduced except in full, without the written approval of KES Co., Ltd.
The results shown in this test report refer only to the sample(s) tested unless otherwise stated.

EUT Internal View – Serve board

(Top)

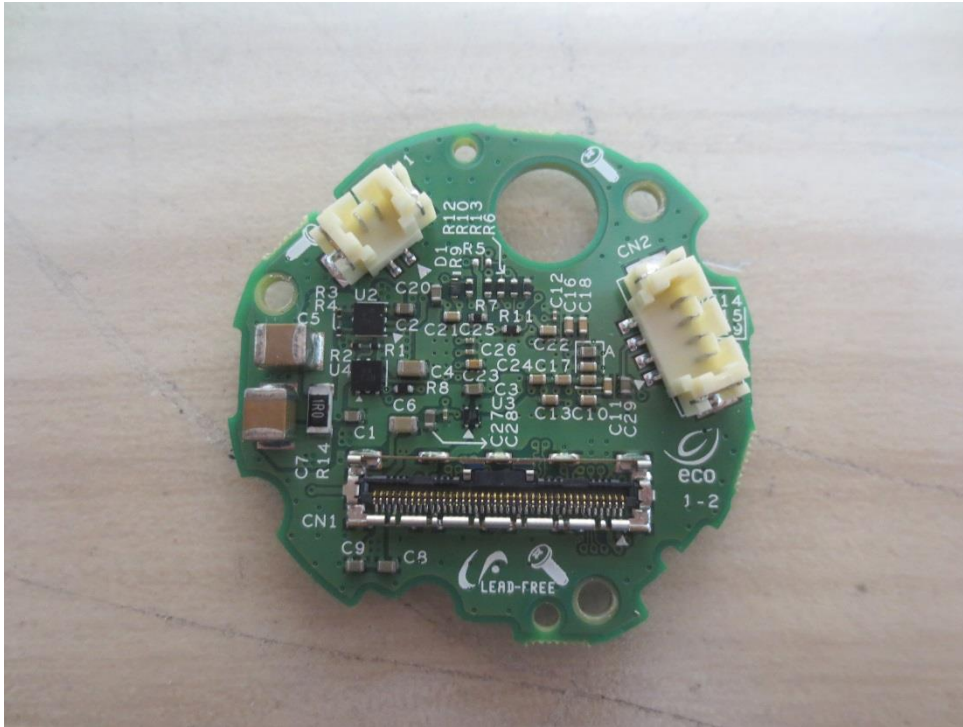

(Bottom)



This report shall not be reproduced except in full, without the written approval of KES Co., Ltd.
The results shown in this test report refer only to the sample(s) tested unless otherwise stated.

Label and Location



Network Camera

Model No : XNV-6012M

Manufacturer : HANWHA TECHWIN(TIANJIN)CO., LTD

Made in China

