





<b>TEST REPORT</b> <b>IEC/EN 60950-1</b> <b>Information technology equipment – Safety –</b> <b>Part 1: General requirements</b>	
<b>Report Number</b> .....	KES-SA-19T0073
<b>Date of issue</b> .....	2019-02-28
<b>Total number of pages</b> .....	Total: 75 pages
<b>Tested by</b> (printed name and signature) .....	Jaehun, Lee 
<b>Approved by</b> (printed name and signature) .....	Jaekwan, Cha 
<b>Testing Laboratory</b> .....	KES Co., Ltd. / Electrical Safety Laboratory
<b>Address</b> .....	473-21, Gayeo-ro, Yeosu-si, Gyeonggi-do, 12658, Republic of Korea
<b>Applicant's name</b> .....	Hanwha Techwin Co., Ltd.
<b>Address</b> .....	Pangyo-ro 319 Beon-gil, Bundang-gu, Seongnam-si, Gyeonggi-do, 13488, KOREA
<b>Test specification:</b>	
<b>Standard</b> .....	<input checked="" type="checkbox"/> EN 60950-1:2006+A11:2009+A1:2010+A12:2011+A2:2013
<b>Test procedure</b> .....	-
<b>Non-standard test method</b> .....	N/A
<b>Test Report Form No</b> .....	IEC60950_1F
<b>Test Report Form(s) Originator</b> .....	SGS Fimko Ltd
<b>Master TRF</b> .....	Dated 2014-02
<b>Copyright © 2014 Worldwide System for Conformity Testing and Certification of Electrotechnical Equipment and Components (IECEE System). All rights reserved.</b> This publication may be reproduced in whole or in part for non-commercial purposes as long as the IECEE is acknowledged as copyright owner and source of the material. IECEE takes no responsibility for and will not assume liability for damages resulting from the reader's interpretation of the reproduced material due to its placement and context.	
<b>Test item description</b> .....	NVR (NETWORK VIDEO RECORDER)
<b>Trade Mark</b> .....	
<b>Manufacturer</b> .....	HANWHA TECHWIN(TIANJIN) CO., LTD No.11 Weiliu Rd, Micro-Electronic Industrial Park, TEDA, Tianjin,300385, People's Republic of China
<b>Model/Type reference</b> .....	TRM-810S
<b>Ratings</b> .....	DC 9 – 36 V $\overline{\text{---}}$ , 13.5 A

This test report is not related to KOLAS

**List of attachments (including a total number of pages in each attachment):**







- Attachment 1 : European differences and national differences ..... 19 pages
- Attachment 2 : Photos ..... 7 pages

**Summary of testing:**

Language of safety markings / instructions (Clause 1.7.2.1)	Instructions and equipment marking related to safety is applied in the language that is acceptable in the country in which the equipment is to be sold.
Limited power sources (Clause 2.5)	In this report, the LPS test was tested only for the output voltage line, except for signals line on the ports. Also PoE output ports does not comply with the Limited Power Sources (LPS) test in the Clause 2.5.

**Copy of marking plate:**

The artwork below may be only a draft.

<p>NETWORK VIDEO RECORDER          MODEL : TRM-810S          DC 9-36V  13.5A          M/C: TRM-810S/KUS      Fac. ID : D            [년월]      S/N: [제조번호]          CAN ICES-3(A)/NMB-3(A)          ETHERNET 1 ADD.: XX-XX-XX-XX-XX-XX          ETHERNET 2 ADD.: XX-XX-XX-XX-XX-XX          MADE IN KOREA</p>	    <p>PT03-002663D</p>
--	--

**Model difference:** N/A

This report shall not be reproduced except in full, without the written approval of KES Co., Ltd.  
 The results shown in this test report refer only to the sample(s) tested unless otherwise stated.  
 The authenticity of the test report, contact shchoi@kes.co.kr



<b>Test item particulars</b> .....	
Equipment mobility .....	<input type="checkbox"/> movable <input type="checkbox"/> hand-held <input type="checkbox"/> transportable <input checked="" type="checkbox"/> stationary <input type="checkbox"/> for building-in <input type="checkbox"/> direct plug-in
Connection to the mains.....	<input type="checkbox"/> pluggable equipment <input type="checkbox"/> type A <input type="checkbox"/> type B <input type="checkbox"/> permanent connection <input type="checkbox"/> detachable power supply cord <input type="checkbox"/> non-detachable power supply cord <input checked="" type="checkbox"/> not directly connected to the mains
Operating condition .....	<input checked="" type="checkbox"/> continuous <input type="checkbox"/> rated operating / resting time:
Access location .....	<input checked="" type="checkbox"/> operator accessible <input type="checkbox"/> restricted access location
Over voltage category (OVC) .....	<input checked="" type="checkbox"/> OVC I <input type="checkbox"/> OVC II <input type="checkbox"/> OVC III <input type="checkbox"/> OVC IV <input type="checkbox"/> other:
Mains supply tolerance (%) or absolute mains supply values .....	-
Tested for IT power systems .....	<input type="checkbox"/> Yes <input checked="" type="checkbox"/> No
IT testing, phase-phase voltage (V) .....	N/A
Class of equipment .....	<input type="checkbox"/> Class I <input type="checkbox"/> Class II <input checked="" type="checkbox"/> Class III <input type="checkbox"/> Not classified
Considered current rating of protective device as part of the building installation (A) .....	-
Pollution degree (PD) .....	<input type="checkbox"/> PD 1 <input checked="" type="checkbox"/> PD 2 <input type="checkbox"/> PD 3
IP protection class .....	IPX0
Altitude during operation (m) .....	Up to 2000 m
Altitude of test laboratory (m) .....	Up to 2000 m
Mass of equipment (kg) .....	Approx. 3.7 kg (include HDD (2 EA))
<b>Possible test case verdicts:</b>	
- test case does not apply to the test object .....	
- test object does meet the requirement .....	
- test object does not meet the requirement .....	
<b>Testing</b> .....	
Date of receipt of test item .....	2019-01-22
Date(s) of performance of tests .....	2019-01-22 to 2019-02-28
<b>General remarks:</b>	
The test results presented in this report relate only to the object tested. This report shall not be reproduced, except in full, without the written approval of the Issuing testing laboratory. "(see Enclosure #)" refers to additional information appended to the report. "(see appended table)" refers to a table appended to the report.	
Throughout this report a <input type="checkbox"/> comma / <input checked="" type="checkbox"/> point is used as the decimal separator.	

This report shall not be reproduced except in full, without the written approval of KES Co., Ltd.  
 The results shown in this test report refer only to the sample(s) tested unless otherwise stated.  
 The authenticity of the test report, contact shchoi@kes.co.kr



**When differences exist; they shall be identified in the General product information section.**

<b>Name and address of factory (ies) .....</b>	1. HANWHA TECHWIN SECURITY VIETNAM CO., LTD. Lot O-2, Que Vo Industrial Zone extended area, Nam Son commune, Bac Ninh city, Bac Ninh province, Vietnam  2. D-TECH CO., LTD. 173-25, Saneop-ro, Gwonseon-gu, Suwon-si, Gyeonggi-do, Korea (Suwon Industrial Complex)
--	---

**General product information:**

**Report Summary:**

- All applicable tests according to the referenced standard(s) have been carried out.
- The equipment is tested by radio equipment request according to article 3.1.(a) of Radio Equipment Directive (RED).
- The maximum ambient temperature permitted by manufacturer ( $T_{ma}$ ) : 40 °C
- Max. normal load condition as follows:
  - 1) Load applied to each USB 2.0 port (3 EA) is 0.5 A,
  - 2) Image recording mode with CCTV cameras delivered by manufacturer,
  - 3) Connected the monitor to the VGA (RS232) port and HDMI port,
  - 4) Connected control box and GPS module provided with the device to the corresponding port.
  - 5) Connected to Wi-Fi mode.

**Product Descriptions:**

- The equipment was evaluated to Class III construction.
- On the front side, there is a slot to replace the HDD. remove the slot with HDD, the equipment will not work.
- Port configurations  
 On front panel: USB 2.0 ports (2 EA), HDMI port, VGA port, CONSOLE port, AUDIO port.  
 On rear side : USB 2.0 port, PoE ports (8 EA), VIEWER port, CONTROL BOX port, GPS port, ALARM OUT port, ALARM IN port, RESERVED port, DC power input port, WIFI ANT port.

**Technical Considerations:**

- Exposure to extreme temperatures, excessive dust, moisture or vibration; to flammable gases; to corrosive or explosive atmospheres: This equipment is intended to operate in a "normal" environment (Offices and homes).
- Electro-medical equipment connected to the patient: The equipment is not an electro medical equipment intended to be physically connected to patient.
- Equipment used in vehicles, ships or aircrafts, in tropical countries, or at elevations > 2 000 m: This equipment is intended to operate in a "normal" environment (Offices and homes).

This report shall not be reproduced except in full, without the written approval of KES Co., Ltd.  
 The results shown in this test report refer only to the sample(s) tested unless otherwise stated.  
 The authenticity of the test report, contact shchoi@kes.co.kr



**KES Co., Ltd.**

3701, 40, Simin-daero 365beon-gil,  
Dongan-gu, Anyang-si, Gyeonggi-do, 14057, Korea  
Tel: +82-31-425-6200 / Fax: +82-31-424-0450  
www.kes.co.kr

Report No.:  
KES-SA-19T0073  
Page ( 5) of ( 75)

**Abbreviations used in the report:**

- normal conditions	N.C.	- single fault conditions	S.F.C
- functional insulation	OP	- basic insulation	BI
- double insulation	DI	- supplementary insulation	SI
- between parts of opposite polarity	BOP	- reinforced insulation	RI

**Indicate used abbreviations (if any)**

This report shall not be reproduced except in full, without the written approval of KES Co., Ltd.  
The results shown in this test report refer only to the sample(s) tested unless otherwise stated.  
The authenticity of the test report, contact shchoi@kes.co.kr



<b>IEC/EN 60950-1</b>			
Clause	Requirement + Test	Result - Remark	Verdict
<b>1</b>	<b>GENERAL</b>		<b>P</b>
<b>1.5</b>	<b>Components</b>		<b>P</b>
1.5.1	General		<b>P</b>
	Comply with IEC 60950-1 or relevant component standard	(see appended table 1.5.1)	<b>P</b>
1.5.2	Evaluation and testing of components	<p>Certified components are used in accordance with their ratings, certifications and they comply with applicable parts of this standard.</p> <p>Components not certified are used in accordance with their ratings and they comply with applicable parts of IEC 60950-1 and the relevant component standard.</p> <p>Components, for which no relevant IEC-standard exists, have been tested under the conditions occurring in the equipment, using applicable parts of IEC 60950-1.</p>	<b>P</b>
1.5.3	Thermal controls	No thermal controls.	<b>N/A</b>
1.5.4	Transformers	No such components.	<b>N/A</b>
1.5.5	Interconnecting cables	No risk required by this standard.	<b>P</b>
1.5.6	Capacitors bridging insulation	Class III equipment.	<b>N/A</b>
1.5.7	Resistors bridging insulation	Class III equipment.	<b>N/A</b>
1.5.7.1	Resistors bridging functional, basic or supplementary insulation		<b>N/A</b>
1.5.7.2	Resistors bridging double or reinforced insulation between a.c. mains and other circuits		<b>N/A</b>
1.5.7.3	Resistors bridging double or reinforced insulation between a.c. mains and antenna or coaxial cable		<b>N/A</b>
1.5.8	Components in equipment for IT power systems	Class III equipment.	<b>N/A</b>
1.5.9	Surge suppressors	Class III equipment.	<b>N/A</b>
1.5.9.1	General	Class III equipment.	<b>N/A</b>
1.5.9.2	Protection of VDRs		<b>N/A</b>
1.5.9.3	Bridging of functional insulation by a VDR		<b>N/A</b>
1.5.9.4	Bridging of basic insulation by a VDR		<b>N/A</b>

This report shall not be reproduced except in full, without the written approval of KES Co., Ltd.  
 The results shown in this test report refer only to the sample(s) tested unless otherwise stated.  
 The authenticity of the test report, contact shchoi@kes.co.kr



<b>IEC/EN 60950-1</b>			
Clause	Requirement + Test	Result - Remark	Verdict
1.5.9.5	Bridging of supplementary, double or reinforced insulation by a VDR		N/A
<b>1.6</b>	<b>Power interface</b>		<b>P</b>
1.6.1	AC power distribution systems	Class III equipment	N/A
1.6.2	Input current	(see appended table 1.6.2)	P
1.6.3	Voltage limit of hand-held equipment		N/A
1.6.4	Neutral conductor	Class III equipment	N/A
<b>1.7</b>	<b>Marking and instructions</b>		<b>P</b>
1.7.1	Power rating and identification markings		P
1.7.1.1	Power rating marking	d.c. powered equipment without means for direct connection to a mains supply	P
	Multiple mains supply connections.....:	No multiple mains supply connections.	N/A
	Rated voltage(s) or voltage range(s) (V) .....	DC 9 – 36 V $\overline{---}$	P
	Symbol for nature of supply, for d.c. only .....	IEC 60417-1 (No. 5031) symbol is used.	P
	Rated frequency or rated frequency range (Hz) ...:	Class III equipment	N/A
	Rated current (mA or A) .....	13.5 A	P
1.7.1.2	Identification markings	Refer below:	P
	Manufacturer's name or trade-mark or identification mark .....		P
	Model identification or type reference .....	TRM-810S	P
	Symbol for Class II equipment only .....	Class III equipment	N/A
	Other markings and symbols .....	The additional marking does not give rise to misunderstandings	P
1.7.1.3	Use of graphical symbols	No graphic symbols designed by the manufacturer	N/A
1.7.2	Safety instructions and marking	Refer below:	P
1.7.2.1	General	The user's manual contains information for operation, installation, servicing, transport, storage and technical data. The operation guide is provided to the user.	P
1.7.2.2	Disconnect devices	Class III equipment	N/A
1.7.2.3	Overcurrent protective device	Class III equipment	N/A

This report shall not be reproduced except in full, without the written approval of KES Co., Ltd.  
 The results shown in this test report refer only to the sample(s) tested unless otherwise stated.  
 The authenticity of the test report, contact shchoi@kes.co.kr



<b>IEC/EN 60950-1</b>			
Clause	Requirement + Test	Result - Remark	Verdict
1.7.2.4	IT power distribution systems	Class III equipment	N/A
1.7.2.5	Operator access with a tool	The operator is not instructed to use a tool to gain access to operator access areas.	N/A
1.7.2.6	Ozone	The equipment does not containing ozone.	N/A
1.7.3	Short duty cycles	The equipment is intended for continuous operation.	N/A
1.7.4	Supply voltage adjustment .....	No voltage adjustment	N/A
	Methods and means of adjustment; reference to installation instructions .....		N/A
1.7.5	Power outlets on the equipment .....	No standard power outlets	N/A
1.7.6	Fuse identification (marking, special fusing characteristics, cross-reference) .....	No fuse relative with safety.	N/A
1.7.7	Wiring terminals	Refer to below;	N/A
1.7.7.1	Protective earthing and bonding terminals .....	Class III equipment	N/A
1.7.7.2	Terminals for a.c. mains supply conductors	Class III equipment	N/A
1.7.7.3	Terminals for d.c. mains supply conductors	The equipment is not for connection to a d.c. mains supply.	N/A
1.7.8	Controls and indicators	Refer below;	N/A
1.7.8.1	Identification, location and marking .....	No controls affecting safety in the equipment.	N/A
1.7.8.2	Colours .....		N/A
1.7.8.3	Symbols according to IEC 60417 .....		N/A
1.7.8.4	Markings using figures .....	No controls use figures.	N/A
1.7.9	Isolation of multiple power sources .....	Class III equipment	N/A
1.7.10	Thermostats and other regulating devices .....	No such devices	N/A
1.7.11	Durability	15 s with water and then 15 s with petroleum spirit Readable and not erased after the test	P
1.7.12	Removable parts	Marking is not place on removable parts	P
1.7.13	Replaceable batteries .....	No replaceable batteries	N/A
	Language(s) .....		—
1.7.14	Equipment for restricted access locations .....	Equipment not intended for installation in restricted access locations	N/A

This report shall not be reproduced except in full, without the written approval of KES Co., Ltd.  
 The results shown in this test report refer only to the sample(s) tested unless otherwise stated.  
 The authenticity of the test report, contact shchoi@kes.co.kr





<b>IEC/EN 60950-1</b>			
Clause	Requirement + Test	Result - Remark	Verdict
<b>2</b>	<b>PROTECTION FROM HAZARDS</b>		<b>P</b>
<b>2.1</b>	<b>Protection from electric shock and energy hazards</b>		<b>N/A</b>
2.1.1	Protection in operator access areas	Class III equipment and only containing SELV circuit.	N/A
2.1.1.1	Access to energized parts	No hazardous voltage and hazardous energy level existed	N/A
	Test by inspection .....		N/A
	Test with test finger (Figure 2A) .....		N/A
	Test with test pin (Figure 2B) .....		N/A
	Test with test probe (Figure 2C) .....		N/A
2.1.1.2	Battery compartments	No TNV circuit	N/A
2.1.1.3	Access to ELV wiring	No internal wiring at ELV accessible to the operator	N/A
	Working voltage (V <sub>peak</sub> or V <sub>rms</sub> ); minimum distance through insulation (mm)		—
2.1.1.4	Access to hazardous voltage circuit wiring	No internal wiring at hazardous voltage accessible to operator	N/A
2.1.1.5	Energy hazards .....	Class III equipment, No hazardous energy level existed.	N/A
2.1.1.6	Manual controls		N/A
2.1.1.7	Discharge of capacitors in equipment	Class III equipment	N/A
	Measured voltage (V); time-constant (s) .....		—
2.1.1.8	Energy hazards – d.c. mains supply	Not intended to be connected to mains supply	N/A
	a) Capacitor connected to the d.c. mains supply ...		N/A
	b) Internal battery connected to the d.c. mains supply .....		N/A
2.1.1.9	Audio amplifiers .....	No audio amplifiers	N/A
2.1.2	Protection in service access areas	No electric shock and energy hazard	N/A
2.1.3	Protection in restricted access locations	Not intended for installation in restricted access locations	N/A

This report shall not be reproduced except in full, without the written approval of KES Co., Ltd.  
 The results shown in this test report refer only to the sample(s) tested unless otherwise stated.  
 The authenticity of the test report, contact shchoi@kes.co.kr



<b>IEC/EN 60950-1</b>			
Clause	Requirement + Test	Result - Remark	Verdict
<b>2.2</b>	<b>SELV circuits</b>		N/A
2.2.1	General requirements	Class III equipment and only containing SELV circuit.	N/A
2.2.2	Voltages under normal conditions (V) ..... :		N/A
2.2.3	Voltages under fault conditions (V) ..... :		N/A
2.2.4	Connection of SELV circuits to other circuits .....:		N/A
<b>2.3</b>	<b>TNV circuits</b>		N/A
2.3.1	Limits	No TNV circuits	N/A
	Type of TNV circuits ..... :		—
2.3.2	Separation from other circuits and from accessible parts		N/A
2.3.2.1	General requirements		N/A
2.3.2.2	Protection by basic insulation		N/A
2.3.2.3	Protection by earthing		N/A
2.3.2.4	Protection by other constructions ..... :		N/A
2.3.3	Separation from hazardous voltages		N/A
	Insulation employed..... :		—
2.3.4	Connection of TNV circuits to other circuits		N/A
	Insulation employed..... :		—
2.3.5	Test for operating voltages generated externally		N/A
<b>2.4</b>	<b>Limited current circuits</b>		N/A
2.4.1	General requirements	No limited current circuits in the equipment.	N/A
2.4.2	Limit values		N/A
	Frequency (Hz) ..... :		—
	Measured current (mA)..... :		—
	Measured voltage (V) ..... :		—
	Measured circuit capacitance (nF or $\mu$ F)..... :		—
2.4.3	Connection of limited current circuits to other circuits		N/A

This report shall not be reproduced except in full, without the written approval of KES Co., Ltd.  
 The results shown in this test report refer only to the sample(s) tested unless otherwise stated.  
 The authenticity of the test report, contact shchoi@kes.co.kr



<b>IEC/EN 60950-1</b>			
Clause	Requirement + Test	Result - Remark	Verdict
<b>2.5</b>	<b>Limited power sources</b>		P
	a) Inherently limited output	CONTROL BOX, GPS, ALARM IN, RESERVED and PoE ports  The PoE output ports does not comply with the Limited Power Sources (LPS) test.	P
	b) Impedance limited output		N/A
	c) Regulating network limited output under normal operating and single fault condition	USB (2.0) and HDMI ports	P
	Use of integrated circuit (IC) current limiters	(see appended table 2.5)	P
	d) Overcurrent protective device limited output		N/A
	Max. output voltage (V), max. output current (A), max. apparent power (VA)..... :	(see appended table 2.5)	—
	Current rating of overcurrent protective device (A) .. :		—

<b>2.6</b>	<b>Provisions for earthing and bonding</b>		N/A
2.6.1	Protective earthing	Class III equipment	N/A
2.6.2	Functional earthing		N/A
	Use of symbol for functional earthing .....		N/A
2.6.3	Protective earthing and protective bonding conductors		N/A
2.6.3.1	General		N/A
2.6.3.2	Size of protective earthing conductors		N/A
	Rated current (A), cross-sectional area (mm <sup>2</sup> ), AWG .....		—
2.6.3.3	Size of protective bonding conductors		N/A
	Rated current (A), cross-sectional area (mm <sup>2</sup> ), AWG .....		—
	Protective current rating (A), cross-sectional area (mm <sup>2</sup> ), AWG .....		—
2.6.3.4	Resistance of earthing conductors and their terminations; resistance ( $\Omega$ ), voltage drop (V), test current (A), duration (min) .....		N/A
2.6.3.5	Colour of insulation .....		N/A
2.6.4	Terminals		N/A
2.6.4.1	General		N/A
2.6.4.2	Protective earthing and bonding terminals		N/A

This report shall not be reproduced except in full, without the written approval of KES Co., Ltd.  
 The results shown in this test report refer only to the sample(s) tested unless otherwise stated.  
 The authenticity of the test report, contact shchoi@kes.co.kr



<b>IEC/EN 60950-1</b>			
Clause	Requirement + Test	Result - Remark	Verdict
	Rated current (A), type, nominal thread diameter (mm) .....		—
2.6.4.3	Separation of the protective earthing conductor from protective bonding conductors		N/A
2.6.5	Integrity of protective earthing		N/A
2.6.5.1	Interconnection of equipment		N/A
2.6.5.2	Components in protective earthing conductors and protective bonding conductors		N/A
2.6.5.3	Disconnection of protective earth		N/A
2.6.5.4	Parts that can be removed by an operator		N/A
2.6.5.5	Parts removed during servicing		N/A
2.6.5.6	Corrosion resistance		N/A
2.6.5.7	Screws for protective bonding		N/A
2.6.5.8	Reliance on telecommunication network or cable distribution system		N/A
<b>2.7</b>	<b>Overcurrent and earth fault protection in primary circuits</b>		N/A
2.7.1	Basic requirements	Class III equipment	N/A
	Instructions when protection relies on building installation		N/A
2.7.2	Faults not simulated in 5.3.7		N/A
2.7.3	Short-circuit backup protection		N/A
2.7.4	Number and location of protective devices .....		N/A
2.7.5	Protection by several devices		N/A
2.7.6	Warning to service personnel .....		N/A
<b>2.8</b>	<b>Safety interlocks</b>		N/A
2.8.1	General principles	No safety interlocks provided	N/A
2.8.2	Protection requirements		N/A
2.8.3	Inadvertent reactivation		N/A
2.8.4	Fail-safe operation		N/A
	Protection against extreme hazard		N/A
2.8.5	Moving parts		N/A
2.8.6	Overriding		N/A
2.8.7	Switches, relays and their related circuits		N/A
2.8.7.1	Separation distances for contact gaps and their related circuits (mm) .....		N/A

This report shall not be reproduced except in full, without the written approval of KES Co., Ltd.  
 The results shown in this test report refer only to the sample(s) tested unless otherwise stated.  
 The authenticity of the test report, contact shchoi@kes.co.kr



<b>IEC/EN 60950-1</b>			
Clause	Requirement + Test	Result - Remark	Verdict
2.8.7.2	Overload test		N/A
2.8.7.3	Endurance test		N/A
2.8.7.4	Electric strength test		N/A
2.8.8	Mechanical actuators		N/A

<b>2.9</b>	<b>Electrical insulation</b>		N/A
2.9.1	Class III equipment. No electrical insulation's required for safety purpose	Class III equipment. No electrical insulation's required for safety purpose	N/A
2.9.2	Humidity conditioning		N/A
	Relative humidity (%), temperature (°C) ..... :		—
2.9.3	Grade of insulation		N/A
2.9.4	Separation from hazardous voltages		N/A
	Method(s) used ..... :		—

<b>2.10</b>	<b>Clearances, creepage distances and distances through insulation</b>		N/A
2.10.1	General	Class III equipment.	N/A
2.10.1.1	Frequency .....:		N/A
2.10.1.2	Pollution degrees .....:		N/A
2.10.1.3	Reduced values for functional insulation		N/A
2.10.1.4	Intervening unconnected conductive parts		N/A
2.10.1.5	Insulation with varying dimensions		N/A
2.10.1.6	Special separation requirements		N/A
2.10.1.7	Insulation in circuits generating starting pulses		N/A
2.10.2	Determination of working voltage		N/A
2.10.2.1	General		N/A
2.10.2.2	RMS working voltage		N/A
2.10.2.3	Peak working voltage		N/A
2.10.3	Clearances		N/A
2.10.3.1	General		N/A
2.10.3.2	Mains transient voltages		N/A
	a) AC mains supply .....:		N/A
	b) Earthed d.c. mains supplies .....:		N/A
	c) Unearthed d.c. mains supplies .....:		N/A
	d) Battery operation .....:		N/A
2.10.3.3	Clearances in primary circuits		N/A

This report shall not be reproduced except in full, without the written approval of KES Co., Ltd.  
 The results shown in this test report refer only to the sample(s) tested unless otherwise stated.  
 The authenticity of the test report, contact shchoi@kes.co.kr



<b>IEC/EN 60950-1</b>			
Clause	Requirement + Test	Result - Remark	Verdict
2.10.3.4	Clearances in secondary circuits		N/A
2.10.3.5	Clearances in circuits having starting pulses		N/A
2.10.3.6	Transients from a.c. mains supply .....		N/A
2.10.3.7	Transients from d.c. mains supply .....		N/A
2.10.3.8	Transients from telecommunication networks and cable distribution systems .....		N/A
2.10.3.9	Measurement of transient voltage levels		N/A
	a) Transients from a mains supply		N/A
	For an a.c. mains supply .....		N/A
	For a d.c. mains supply .....		N/A
	b) Transients from a telecommunication network :		N/A
2.10.4	Creepage distances		N/A
2.10.4.1	General		N/A
2.10.4.2	Material group and comparative tracking index		N/A
	CTI tests .....		—
2.10.4.3	Minimum creepage distances		N/A
2.10.5	Solid insulation		N/A
2.10.5.1	General		N/A
2.10.5.2	Distances through insulation		N/A
2.10.5.3	Insulating compound as solid insulation		N/A
2.10.5.4	Semiconductor devices		N/A
2.10.5.5.	Cemented joints		N/A
2.10.5.6	Thin sheet material – General		N/A
2.10.5.7	Separable thin sheet material		N/A
	Number of layers (pcs) .....		—
2.10.5.8	Non-separable thin sheet material		N/A
2.10.5.9	Thin sheet material – standard test procedure		N/A
	Electric strength test		—
2.10.5.10	Thin sheet material – alternative test procedure		N/A
	Electric strength test		—
2.10.5.11	Insulation in wound components		N/A
2.10.5.12	Wire in wound components		N/A
	Working voltage .....		N/A
	a) Basic insulation not under stress .....		N/A

This report shall not be reproduced except in full, without the written approval of KES Co., Ltd.  
 The results shown in this test report refer only to the sample(s) tested unless otherwise stated.  
 The authenticity of the test report, contact shchoi@kes.co.kr



<b>IEC/EN 60950-1</b>			
Clause	Requirement + Test	Result - Remark	Verdict
	b) Basic, supplementary, reinforced insulation .....		N/A
	c) Compliance with Annex U .....		N/A
	Two wires in contact inside wound component; angle between 45° and 90° .....		N/A
2.10.5.13	Wire with solvent-based enamel in wound components		N/A
	Electric strength test		—
	Routine test		N/A
2.10.5.14	Additional insulation in wound components		N/A
	Working voltage .....		N/A
	- Basic insulation not under stress .....		N/A
	- Supplementary, reinforced insulation .....		N/A
2.10.6	Construction of printed boards		N/A
2.10.6.1	Uncoated printed boards		N/A
2.10.6.2	Coated printed boards		N/A
2.10.6.3	Insulation between conductors on the same inner surface of a printed board		N/A
2.10.6.4	Insulation between conductors on different layers of a printed board		N/A
	Distance through insulation		N/A
	Number of insulation layers (pcs) .....		
2.10.7	Component external terminations		N/A
2.10.8	Tests on coated printed boards and coated components		N/A
2.10.8.1	Sample preparation and preliminary inspection		N/A
2.10.8.2	Thermal conditioning		N/A
2.10.8.3	Electric strength test		N/A
2.10.8.4	Abrasion resistance test		N/A
2.10.9	Thermal cycling		N/A
2.10.10	Test for Pollution Degree 1 environment and insulating compound		N/A
2.10.11	Tests for semiconductor devices and cemented joints		N/A
2.10.12	Enclosed and sealed parts		N/A

This report shall not be reproduced except in full, without the written approval of KES Co., Ltd.  
 The results shown in this test report refer only to the sample(s) tested unless otherwise stated.  
 The authenticity of the test report, contact shchoi@kes.co.kr



<b>IEC/EN 60950-1</b>			
Clause	Requirement + Test	Result - Remark	Verdict
<b>3</b>	<b>WIRING, CONNECTIONS AND SUPPLY</b>		P
<b>3.1</b>	<b>General</b>		N/A
3.1.1	Current rating and overcurrent protection	Class III equipment. No direct connection to a.c. or d.c. mains supply.	N/A
3.1.2	Protection against mechanical damage		N/A
3.1.3	Securing of internal wiring		N/A
3.1.4	Insulation of conductors		N/A
3.1.5	Beads and ceramic insulators		N/A
3.1.6	Screws for electrical contact pressure		N/A
3.1.7	Insulating materials in electrical connections		N/A
3.1.8	Self-tapping and spaced thread screws		N/A
3.1.9	Termination of conductors		N/A
	10 N pull test		—
3.1.10	Sleeving on wiring		N/A
<b>3.2</b>	<b>Connection to a mains supply</b>		N/A
3.2.1	Means of connection	Class III equipment	N/A
3.2.1.1	Connection to an a.c. mains supply		N/A
3.2.1.2	Connection to a d.c. mains supply		N/A
3.2.2	Multiple supply connections		N/A
3.2.3	Permanently connected equipment		N/A
	Number of conductors, diameter of cable and conduits (mm) .....		—
3.2.4	Appliance inlets		N/A
3.2.5	Power supply cords		N/A
3.2.5.1	AC power supply cords		N/A
	Type .....		—
	Rated current (A), cross-sectional area (mm <sup>2</sup> ), AWG .....		—
3.2.5.2	DC power supply cords		N/A
3.2.6	Cord anchorages and strain relief		N/A
	Mass of equipment (kg), pull (N) .....		—
	Longitudinal displacement (mm) .....		—
3.2.7	Protection against mechanical damage		N/A

This report shall not be reproduced except in full, without the written approval of KES Co., Ltd.  
 The results shown in this test report refer only to the sample(s) tested unless otherwise stated.  
 The authenticity of the test report, contact shchoi@kes.co.kr





<b>IEC/EN 60950-1</b>			
Clause	Requirement + Test	Result - Remark	Verdict
3.2.8	Cord guards		N/A
	Diameter or minor dimension D (mm); test mass (g) ..... :		—
	Radius of curvature of cord (mm)..... :		—
3.2.9	Supply wiring space		N/A

<b>3.3</b>	<b>Wiring terminals for connection of external conductors</b>		N/A
3.3.1	Wiring terminals	Class III equipment. No direct connection to a.c. or d.c. mains supply.	N/A
3.3.2	Connection of non-detachable power supply cords		N/A
3.3.3	Screw terminals		N/A
3.3.4	Conductor sizes to be connected		N/A
	Rated current (A), cord/cable type, cross-sectional area (mm <sup>2</sup> )..... :		—
3.3.5	Wiring terminal sizes		N/A
	Rated current (A), type, nominal thread diameter (mm) ..... :		—
3.3.6	Wiring terminal design		N/A
3.3.7	Grouping of wiring terminals		N/A
3.3.8	Stranded wire		N/A

<b>3.4</b>	<b>Disconnection from the mains supply</b>		N/A
3.4.1	General requirement	Class III equipment	N/A
3.4.2	Disconnect devices		N/A
3.4.3	Permanently connected equipment		N/A
3.4.4	Parts which remain energized		N/A
3.4.5	Switches in flexible cords		N/A
3.4.6	Number of poles - single-phase and d.c. equipment		N/A
3.4.7	Number of poles - three-phase equipment		N/A
3.4.8	Switches as disconnect devices		N/A
3.4.9	Plugs as disconnect devices		N/A
3.4.10	Interconnected equipment		N/A
3.4.11	Multiple power sources		N/A

This report shall not be reproduced except in full, without the written approval of KES Co., Ltd.  
 The results shown in this test report refer only to the sample(s) tested unless otherwise stated.  
 The authenticity of the test report, contact shchoi@kes.co.kr



<b>IEC/EN 60950-1</b>			
Clause	Requirement + Test	Result - Remark	Verdict
<b>3.5</b>	<b>Interconnection of equipment</b>		P
3.5.1	General requirements		P
3.5.2	Types of interconnection circuits .....	SELV circuit	P
3.5.3	ELV circuits as interconnection circuits	No ELV circuit as interconnection circuit	N/A
3.5.4	Data ports for additional equipment	All accessible output ports comply with LPS, except for PoE output ports (see appended table 2.5).	P
<b>4</b>	<b>PHYSICAL REQUIREMENTS</b>		P
<b>4.1</b>	<b>Stability</b>		N/A
	Angle of 10°	< 7 kg	N/A
	Test force (N) .....	The unit is not floor-standing.	N/A
<b>4.2</b>	<b>Mechanical strength</b>		N/A
4.2.1	General	Class III equipment	N/A
	Rack-mounted equipment.		N/A
4.2.2	Steady force test, 10 N	SELV circuit in the equipment	N/A
4.2.3	Steady force test, 30 N	SELV circuit in the equipment	N/A
4.2.4	Steady force test, 250 N	SELV circuit in the equipment	N/A
4.2.5	Impact test	SELV circuit in the equipment	N/A
	Fall test		N/A
	Swing test		N/A
4.2.6	Drop test; height (mm) .....	SELV circuit in the equipment	N/A
4.2.7	Stress relief test	SELV circuit in the equipment	N/A
4.2.8	Cathode ray tubes	CRT(s) not used in the equipment.	N/A
	Picture tube separately certified .....		N/A
4.2.9	High pressure lamps	No high pressure lamps in the equipment.	N/A
4.2.10	Wall or ceiling mounted equipment; force (N) .....	No wall or ceiling mounted equipment	N/A

This report shall not be reproduced except in full, without the written approval of KES Co., Ltd.  
 The results shown in this test report refer only to the sample(s) tested unless otherwise stated.  
 The authenticity of the test report, contact shchoi@kes.co.kr



<b>IEC/EN 60950-1</b>			
Clause	Requirement + Test	Result - Remark	Verdict
<b>4.3</b>	<b>Design and construction</b>		P
4.3.1	Edges and corners	All edges and corners are rounded and/or smoothed.	P
4.3.2	Handles and manual controls; force (N)..... :	No handles, grips, levers or the like that might create a hazard provided	N/A
4.3.3	Adjustable controls	No adjustable controls provided	N/A
4.3.4	Securing of parts	Class III equipment.	N/A
4.3.5	Connection by plugs and sockets	SELV connectors do not comply with IEC 60320 or IEC 60083.	N/A
4.3.6	Direct plug-in equipment	Not direct plug-in equipment	N/A
	Torque .....		—
	Compliance with the relevant mains plug standard .....		N/A
4.3.7	Heating elements in earthed equipment	No heating elements provided	N/A
4.3.8	Batteries	(See appended table 1.5.1)	P
	- Overcharging of a rechargeable battery	(see appended table 4.3.8)	P
	- Unintentional charging of a non-rechargeable battery		N/A
	- Reverse charging of a rechargeable battery	Coin battery is fixed on the PCB, so that it cannot be inserted reversed.	P
	- Excessive discharging rate for any battery	(see appended table 4.3.8)	P
4.3.9	Oil and grease	No oil and grease provided	N/A
4.3.10	Dust, powders, liquids and gases	The equipment does not produce dusts or powders, and does not contain flammable liquids or gases.	N/A
4.3.11	Containers for liquids or gases	No containers for liquids or gases in the equipment.	N/A
4.3.12	Flammable liquids .....	No flammable liquids provided	N/A
	Quantity of liquid (l) .....		N/A
	Flash point (°C) .....		N/A
4.3.13	Radiation	Refer below:	P
4.3.13.1	General	Refer below:	P
4.3.13.2	Ionizing radiation	No ionizing radiation provided	N/A
	Measured radiation (pA/kg) .....		—

This report shall not be reproduced except in full, without the written approval of KES Co., Ltd.  
 The results shown in this test report refer only to the sample(s) tested unless otherwise stated.  
 The authenticity of the test report, contact shchoi@kes.co.kr



<b>IEC/EN 60950-1</b>			
Clause	Requirement + Test	Result - Remark	Verdict
	Measured high-voltage (kV) .....		—
	Measured focus voltage (kV) .....		—
	CRT markings .....		—
4.3.13.3	Effect of ultraviolet (UV) radiation on materials	No UV radiation provided	N/A
	Part, property, retention after test, flammability classification .....		N/A
4.3.13.4	Human exposure to ultraviolet (UV) radiation .....		N/A
4.3.13.5	Lasers (including laser diodes) and LEDs	Refer below:	P
4.3.13.5.1	Lasers (including laser laser diodes)	No lasers	N/A
	Laser class .....		—
4.3.13.5.2	Light emitting diodes (LEDs)	LEDs is used only for function indicator	—
4.3.13.6	Other types .....	The Wireless module operates at safety level which was complies with EN 62311 of RE directive.  Power density at prediction frequency is below 1 mW/cm <sup>2</sup>	P

<b>4.4</b>	<b>Protection against hazardous moving parts</b>		<b>P</b>
4.4.1	General	The DC fan in the HDD slot is in a position that reduces the accessibility of moving parts in the user access area.	P
4.4.2	Protection in operator access areas .....	The moving parts of the DC fan are not brought into contact with the test fingers and the unjointed finger through the opening of the HDD slot.	P
	Household and home/office document/media shredders		N/A
4.4.3	Protection in restricted access locations .....	Not equipment to be installed in a restricted access location	N/A
4.4.4	Protection in service access areas	The DC fan is in the HDD slot and no accidental contact occurs. And to replace the HDD, you have to remove the HDD slot. remove the HDD slot, the device will not work.	P

This report shall not be reproduced except in full, without the written approval of KES Co., Ltd.  
 The results shown in this test report refer only to the sample(s) tested unless otherwise stated.  
 The authenticity of the test report, contact shchoi@kes.co.kr



<b>IEC/EN 60950-1</b>			
Clause	Requirement + Test	Result - Remark	Verdict
4.4.5	Protection against moving fan blades	The DC fan in the HDD slot is in a position that reduces the accessibility of moving parts in the user access area.	N/A
4.4.5.1	General		N/A
	Not considered to cause pain or injury. a).....:		N/A
	Is considered to cause pain, not injury. b) .....		N/A
	Considered to cause injury. c) .....		N/A
4.4.5.2	Protection for users		N/A
	Use of symbol or warning .....		N/A
4.4.5.3	Protection for service persons		N/A
	Use of symbol or warning .....		N/A

<b>4.5</b>	<b>Thermal requirements</b>		P
4.5.1	General		P
4.5.2	Temperature tests	(see appended table 4.5)	P
	Normal load condition per Annex L .....	Complied with Annex L.7	—
4.5.3	Temperature limits for materials	(see appended table 4.5)	P
4.5.4	Touch temperature limits	(see appended table 4.5)	P
4.5.5	Resistance to abnormal heat .....	No thermoplastic parts at hazardous voltage provided	N/A

<b>4.6</b>	<b>Openings in enclosures</b>		P
4.6.1	Top and side openings	Top side; No top openings	P
	Dimensions (mm) .....	Side openings (Front): Fan opening with a hole width of 2mm has an area of approximately 1,680 mm <sup>2</sup> (the object entering the opening can not enter the inside due to the FAN metal bracket).	—
4.6.2	Bottoms of fire enclosures	All parts are in a metal enclosure.	P

This report shall not be reproduced except in full, without the written approval of KES Co., Ltd.  
 The results shown in this test report refer only to the sample(s) tested unless otherwise stated.  
 The authenticity of the test report, contact shchoi@kes.co.kr



<b>IEC/EN 60950-1</b>			
Clause	Requirement + Test	Result - Remark	Verdict
	Construction of the bottom, dimensions (mm) ..... :	<p><u>Maximum dimensions of bottom side rectangular opening;</u>            8 mm (Horizontal size) x 2 mm (Vertical size), parts are not mounted on top of the bottom side rectangular opening within 5 degrees.</p> <p><u>Maximum dimensions of the bottom circular opening;</u>            1.5 mm.</p> <p><u>Metal bottom minimum thickness;</u>            1.0 mm            (The maximum diameter requirement of the circular hole in Table 4D is less than 2.0 mm)</p>	—
4.6.3	Doors or covers in fire enclosures	HDD cases are door lock used. Also, included information for correct removal and reinstallation of the HDD case in user manual	P
4.6.4	Openings in transportable equipment	No transportable equipment	N/A
4.6.4.1	Constructional design measures		N/A
	Dimensions (mm) ..... :		—
4.6.4.2	Evaluation measures for larger openings		N/A
4.6.4.3	Use of metallized parts		N/A
4.6.5	Adhesives for constructional purposes	No barrier or screen secured with adhesive provided	N/A
	Conditioning temperature (°C), time (weeks) ..... :		—

<b>4.7</b>	<b>Resistance to fire</b>		<b>P</b>
4.7.1	Reducing the risk of ignition and spread of flame	Method 1 is used	P
	Method 1, selection and application of components wiring and materials	(see appended table 1.5.1)	P
	Method 2, application of all of simulated fault condition tests		N/A
4.7.2	Conditions for a fire enclosure	Refer below:	P
4.7.2.1	Parts requiring a fire enclosure	The fire enclosure is required to cover all parts (see appended table 1.5.1)	P

This report shall not be reproduced except in full, without the written approval of KES Co., Ltd.  
 The results shown in this test report refer only to the sample(s) tested unless otherwise stated.  
 The authenticity of the test report, contact shchoi@kes.co.kr



<b>IEC/EN 60950-1</b>			
Clause	Requirement + Test	Result - Remark	Verdict
4.7.2.2	Parts not requiring a fire enclosure		N/A
4.7.3	Materials		P
4.7.3.1	General	(see appended table 1.5.1)	P
4.7.3.2	Materials for fire enclosures	Using metal enclosure	P
4.7.3.3	Materials for components and other parts outside fire enclosures	No parts outside the fire enclosure	N/A
4.7.3.4	Materials for components and other parts inside fire enclosures	Min. V-2, except small part mounted on the PCB rated min. V-1	P
4.7.3.5	Materials for air filter assemblies	No air filter assemblies	N/A
4.7.3.6	Materials used in high-voltage components	No high-voltage components	N/A

<b>5</b>	<b>ELECTRICAL REQUIREMENTS AND SIMULATED ABNORMAL CONDITIONS</b>		<b>P</b>
<b>5.1</b>	<b>Touch current and protective conductor current</b>		N/A
5.1.1	General	Class III equipment. Not connected to a telecommunication network voltage circuits.	N/A
5.1.2	Configuration of equipment under test (EUT)		N/A
5.1.2.1	Single connection to an a.c. mains supply		N/A
5.1.2.2	Redundant multiple connections to an a.c. mains supply		N/A
5.1.2.3	Simultaneous multiple connections to an a.c. mains supply		N/A
5.1.3	Test circuit		N/A
5.1.4	Application of measuring instrument		N/A
5.1.5	Test procedure		N/A
5.1.6	Test measurements		N/A
	Supply voltage (V) .....		—
	Measured touch current (mA) .....		—
	Max. allowed touch current (mA) .....		—
	Measured protective conductor current (mA) .....		—
	Max. allowed protective conductor current (mA)....		—
5.1.7	Equipment with touch current exceeding 3,5 mA		N/A
5.1.7.1	General .....		N/A
5.1.7.2	Simultaneous multiple connections to the supply		N/A

This report shall not be reproduced except in full, without the written approval of KES Co., Ltd.  
 The results shown in this test report refer only to the sample(s) tested unless otherwise stated.  
 The authenticity of the test report, contact shchoi@kes.co.kr



<b>IEC/EN 60950-1</b>			
Clause	Requirement + Test	Result - Remark	Verdict
5.1.8	Touch currents to telecommunication networks and cable distribution systems and from telecommunication networks		N/A
5.1.8.1	Limitation of the touch current to a telecommunication network or to a cable distribution system		N/A
	Supply voltage (V) .....		—
	Measured touch current (mA) .....		—
	Max. allowed touch current (mA) .....		—
5.1.8.2	Summation of touch currents from telecommunication networks		N/A
	a) EUT with earthed telecommunication ports .....		N/A
	b) EUT whose telecommunication ports have no reference to protective earth		N/A
<b>5.2</b>	<b>Electric strength</b>		N/A
5.2.1	General	Class III equipment	N/A
5.2.2	Test procedure		N/A
<b>5.3</b>	<b>Abnormal operating and fault conditions</b>		P
5.3.1	Protection against overload and abnormal operation	(see appended table 5.3)	P
5.3.2	Motors	The DC fan is used as a component in the HDD slot	P
5.3.3	Transformers	No safety insulating transformers.	N/A
5.3.4	Functional insulation.....	Complies with c)	P
5.3.5	Electromechanical components	No electromechanical components provided	N/A
5.3.6	Audio amplifiers in ITE .....		N/A
5.3.7	Simulation of faults	(see appended table 5.3)	P
5.3.8	Unattended equipment	No thermostats, temperature limiters or thermal cut-outs	N/A
5.3.9	Compliance criteria for abnormal operating and fault conditions	(see appended table 5.3)	P
5.3.9.1	During the tests	No fire or molten metal occurred and no deformation of enclosure during the tests.	P
5.3.9.2	After the tests	Class III equipment	N/A

This report shall not be reproduced except in full, without the written approval of KES Co., Ltd.  
 The results shown in this test report refer only to the sample(s) tested unless otherwise stated.  
 The authenticity of the test report, contact shchoi@kes.co.kr





<b>IEC/EN 60950-1</b>			
Clause	Requirement + Test	Result - Remark	Verdict
<b>6</b>	<b>CONNECTION TO TELECOMMUNICATION NETWORKS</b>		N/A
<b>6.1</b>	<b>Protection of telecommunication network service persons, and users of other equipment connected to the network, from hazards in the equipment</b>		N/A
6.1.1	Protection from hazardous voltages		N/A
6.1.2	Separation of the telecommunication network from earth		N/A
6.1.2.1	Requirements	No TNV circuits.	N/A
	Supply voltage (V) .....		—
	Current in the test circuit (mA) .....		—
6.1.2.2	Exclusions .....		N/A
<b>6.2</b>	<b>Protection of equipment users from overvoltages on telecommunication networks</b>		N/A
6.2.1	Separation requirements	No TNV circuits	N/A
6.2.2	Electric strength test procedure		N/A
6.2.2.1	Impulse test		N/A
6.2.2.2	Steady-state test		N/A
6.2.2.3	Compliance criteria		N/A
<b>6.3</b>	<b>Protection of the telecommunication wiring system from overheating</b>		N/A
	Max. output current (A) .....	No TNV circuits	—
	Current limiting method .....		—
<b>7</b>	<b>CONNECTION TO CABLE DISTRIBUTION SYSTEMS</b>		N/A
7.1	General	Not intended to be connected to a cable distribution system	N/A
7.2	Protection of cable distribution system service persons, and users of other equipment connected to the system, from hazardous voltages in the equipment		N/A
7.3	Protection of equipment users from overvoltages on the cable distribution system		N/A
7.4	Insulation between primary circuits and cable distribution systems		N/A
7.4.1	General		N/A
7.4.2	Voltage surge test		N/A
7.4.3	Impulse test		N/A

This report shall not be reproduced except in full, without the written approval of KES Co., Ltd.  
 The results shown in this test report refer only to the sample(s) tested unless otherwise stated.  
 The authenticity of the test report, contact shchoi@kes.co.kr



IEC/EN 60950-1			
Clause	Requirement + Test	Result - Remark	Verdict
<b>A</b>	<b>ANNEX A, TESTS FOR RESISTANCE TO HEAT AND FIRE</b>		N/A
<b>A.1</b>	<b>Flammability test for fire enclosures of movable equipment having a total mass exceeding 18 kg, and of stationary equipment (see 4.7.3.2)</b>	All materials have suitable flame class, no testing required.	N/A
A.1.1	Samples .....		—
	Wall thickness (mm) .....		—
A.1.2	Conditioning of samples; temperature (°C) .....		N/A
A.1.3	Mounting of samples .....		N/A
A.1.4	Test flame (see IEC 60695-11-3)		N/A
	Flame A, B, C or D .....		—
A.1.5	Test procedure		N/A
A.1.6	Compliance criteria		N/A
	Sample 1 burning time (s) .....		—
	Sample 2 burning time (s) .....		—
	Sample 3 burning time (s) .....		—
<b>A.2</b>	<b>Flammability test for fire enclosures of movable equipment having a total mass not exceeding 18 kg, and for material and components located inside fire enclosures (see 4.7.3.2 and 4.7.3.4)</b>		N/A
A.2.1	Samples, material .....		—
	Wall thickness (mm) .....		—
A.2.2	Conditioning of samples; temperature (°C) .....		N/A
A.2.3	Mounting of samples .....		N/A
A.2.4	Test flame (see IEC 60695-11-4)		N/A
	Flame A, B or C .....		—
A.2.5	Test procedure		N/A
A.2.6	Compliance criteria		N/A
	Sample 1 burning time (s) .....		—
	Sample 2 burning time (s) .....		—
	Sample 3 burning time (s) .....		—
A.2.7	Alternative test acc. to IEC 60695-11-5, cl. 5 and 9		N/A
	Sample 1 burning time (s) .....		—
	Sample 2 burning time (s) .....		—
	Sample 3 burning time (s) .....		—
<b>A.3</b>	<b>Hot flaming oil test (see 4.6.2)</b>		N/A
A.3.1	Mounting of samples		N/A

This report shall not be reproduced except in full, without the written approval of KES Co., Ltd.  
 The results shown in this test report refer only to the sample(s) tested unless otherwise stated.  
 The authenticity of the test report, contact shchoi@kes.co.kr



<b>IEC/EN 60950-1</b>			
Clause	Requirement + Test	Result - Remark	Verdict
A.3.2	Test procedure		N/A
A.3.3	Compliance criterion		N/A
<b>B</b>	<b>ANNEX B, MOTOR TESTS UNDER ABNORMAL CONDITIONS (see 4.7.2.2 and 5.3.2)</b>		P
<b>B.1</b>	<b>General requirements</b>		P
	Position .....	The DC fan is used as a component in the HDD slot	—
	Manufacturer .....	(see appended table 1.5.1)	—
	Type .....	(see appended table 1.5.1)	—
	Rated values .....	(see appended table 1.5.1)	—
<b>B.2</b>	<b>Test conditions</b>		N/A
<b>B.3</b>	<b>Maximum temperatures</b>		N/A
<b>B.4</b>	<b>Running overload test</b>		N/A
<b>B.5</b>	<b>Locked-rotor overload test</b>		N/A
	Test duration (days) .....		—
	Electric strength test: test voltage (V) .....		—
<b>B.6</b>	<b>Running overload test for d.c. motors in secondary circuits</b>		N/A
B.6.1	General		N/A
B.6.2	Test procedure		N/A
B.6.3	Alternative test procedure		N/A
B.6.4	Electric strength test; test voltage (V) .....		N/A
<b>B.7</b>	<b>Locked-rotor overload test for d.c. motors in secondary circuits</b>		P
B.7.1	General	(see appended table 5.3)	P
B.7.2	Test procedure		N/A
B.7.3	Alternative test procedure	(see appended table 5.3)	P
B.7.4	Electric strength test; test voltage (V) .....		N/A
<b>B.8</b>	<b>Test for motors with capacitors</b>		N/A
<b>B.9</b>	<b>Test for three-phase motors</b>		N/A
<b>B.10</b>	<b>Test for series motors</b>		N/A
	Operating voltage (V) .....		—

This report shall not be reproduced except in full, without the written approval of KES Co., Ltd.  
 The results shown in this test report refer only to the sample(s) tested unless otherwise stated.  
 The authenticity of the test report, contact shchoi@kes.co.kr



<b>IEC/EN 60950-1</b>			
Clause	Requirement + Test	Result - Remark	Verdict
<b>C</b>	<b>ANNEX C, TRANSFORMERS (see 1.5.4 and 5.3.3)</b>		N/A
	Position .....	No isolating transformers in the equipment.	—
	Manufacturer .....		—
	Type .....		—
	Rated values .....		—
	Method of protection .....		—
C.1	Overload test		N/A
C.2	Insulation		N/A
	Protection from displacement of windings .....		N/A
<b>D</b>	<b>ANNEX D, MEASURING INSTRUMENTS FOR TOUCH-CURRENT TESTS (see 5.1.4)</b>		N/A
<b>D.1</b>	<b>Measuring instrument</b>	Class III equipment.	N/A
<b>D.2</b>	<b>Alternative measuring instrument</b>		N/A
<b>E</b>	<b>ANNEX E, TEMPERATURE RISE OF A WINDING (see 1.4.13)</b>		N/A
<b>F</b>	<b>ANNEX F, MEASUREMENT OF CLEARANCES AND CREEPAGE DISTANCES (see 2.10 and Annex G)</b>		N/A
<b>G</b>	<b>ANNEX G, ALTERNATIVE METHOD FOR DETERMINING MINIMUM CLEARANCES</b>		N/A
G.1	Clearances		N/A
G.1.1	General		N/A
G.1.2	Summary of the procedure for determining minimum clearances		N/A
G.2	Determination of mains transient voltage (V)		N/A
G.2.1	AC mains supply .....		N/A
G.2.2	Earthed d.c. mains supplies .....		N/A
G.2.3	Unearthed d.c. mains supplies .....		N/A
G.2.4	Battery operation .....		N/A
G.3	Determination of telecommunication network transient voltage (V) .....		N/A
G.4	Determination of required withstand voltage (V)		N/A
G.4.1	Mains transients and internal repetitive peaks .....		N/A
G.4.2	Transients from telecommunication networks .....		N/A

This report shall not be reproduced except in full, without the written approval of KES Co., Ltd.  
 The results shown in this test report refer only to the sample(s) tested unless otherwise stated.  
 The authenticity of the test report, contact shchoi@kes.co.kr



<b>IEC/EN 60950-1</b>			
Clause	Requirement + Test	Result - Remark	Verdict
G.4.3	Combination of transients		N/A
G.4.4	Transients from cable distribution systems		N/A
G.5	Measurement of transient voltages (V)		N/A
	a) Transients from a mains supply		N/A
	For an a.c. mains supply		N/A
	For a d.c. mains supply		N/A
	b) Transients from a telecommunication network		N/A
G.6	Determination of minimum clearances .....		N/A
<b>H</b>	<b>ANNEX H, IONIZING RADIATION (see 4.3.13)</b>		N/A
<b>J</b>	<b>ANNEX J, TABLE OF ELECTROCHEMICAL POTENTIALS (see 2.6.5.6)</b>		N/A
	Metal(s) used .....		—
<b>K</b>	<b>ANNEX K, THERMAL CONTROLS (see 1.5.3 and 5.3.8)</b>		N/A
K.1	Making and breaking capacity	No thermal controls	N/A
K.2	Thermostat reliability; operating voltage (V) .....		N/A
K.3	Thermostat endurance test; operating voltage (V) .....		N/A
K.4	Temperature limiter endurance; operating voltage (V) .....		N/A
K.5	Thermal cut-out reliability		N/A
K.6	Stability of operation		N/A
<b>L</b>	<b>ANNEX L, NORMAL LOAD CONDITIONS FOR SOME TYPES OF ELECTRICAL BUSINESS EQUIPMENT (see 1.2.2.1 and 4.5.2)</b>		P
L.1	Typewriters		N/A
L.2	Adding machines and cash registers		N/A
L.3	Erasers		N/A
L.4	Pencil sharpeners		N/A
L.5	Duplicators and copy machines		N/A
L.6	Motor-operated files		N/A
L.7	Other business equipment	Maximum normal load	P

This report shall not be reproduced except in full, without the written approval of KES Co., Ltd.  
 The results shown in this test report refer only to the sample(s) tested unless otherwise stated.  
 The authenticity of the test report, contact shchoi@kes.co.kr



<b>IEC/EN 60950-1</b>			
Clause	Requirement + Test	Result - Remark	Verdict
<b>M</b>	<b>ANNEX M, CRITERIA FOR TELEPHONE RINGING SIGNALS (see 2.3.1)</b>		N/A
M.1	Introduction	No Telephone ringing signals.	N/A
M.2	Method A		N/A
M.3	Method B		N/A
M.3.1	Ringling signal		N/A
M.3.1.1	Frequency (Hz) .....		—
M.3.1.2	Voltage (V) .....		—
M.3.1.3	Cadence; time (s), voltage (V) .....		—
M.3.1.4	Single fault current (mA) .....		—
M.3.2	Tripping device and monitoring voltage .....		N/A
M.3.2.1	Conditions for use of a tripping device or a monitoring voltage		N/A
M.3.2.2	Tripping device		N/A
M.3.2.3	Monitoring voltage (V) .....		N/A
<b>N</b>	<b>ANNEX N, IMPULSE TEST GENERATORS (see 1.5.7.2, 1.5.7.3, 2.10.3.9, 6.2.2.1, 7.3.2, 7.4.3 and Clause G.5)</b>		N/A
N.1	ITU-T impulse test generators		N/A
N.2	IEC 60065 impulse test generator		N/A
<b>P</b>	<b>ANNEX P, NORMATIVE REFERENCES</b>		—
<b>Q</b>	<b>ANNEX Q, Voltage dependent resistors (VDRs) (see 1.5.9.1)</b>		N/A
	- Preferred climatic categories .....		N/A
	- Maximum continuous voltage .....		N/A
	- Combination pulse current .....		N/A
	Body of the VDR Test according to IEC60695-11-5.....		N/A
	Body of the VDR. Flammability class of material ( min V-1).....		N/A
<b>R</b>	<b>ANNEX R, EXAMPLES OF REQUIREMENTS FOR QUALITY CONTROL PROGRAMMES</b>		N/A
R.1	Minimum separation distances for unpopulated coated printed boards (see 2.10.6.2)		N/A
R.2	Reduced clearances (see 2.10.3)		N/A

This report shall not be reproduced except in full, without the written approval of KES Co., Ltd.  
 The results shown in this test report refer only to the sample(s) tested unless otherwise stated.  
 The authenticity of the test report, contact shchoi@kes.co.kr



<b>IEC/EN 60950-1</b>			
Clause	Requirement + Test	Result - Remark	Verdict
<b>S</b>	<b>ANNEX S, PROCEDURE FOR IMPULSE TESTING (see 6.2.2.3)</b>		N/A
S.1	Test equipment		N/A
S.2	Test procedure		N/A
S.3	Examples of waveforms during impulse testing		N/A
<b>T</b>	<b>ANNEX T, GUIDANCE ON PROTECTION AGAINST INGRESS OF WATER (see 1.1.2)</b>		N/A
			—
<b>U</b>	<b>ANNEX U, INSULATED WINDING WIRES FOR USE WITHOUT INTERLEAVED INSULATION (see 2.10.5.4)</b>		N/A
			—
<b>V</b>	<b>ANNEX V, AC POWER DISTRIBUTION SYSTEMS (see 1.6.1)</b>		N/A
V.1	Introduction		N/A
V.2	TN power distribution systems		N/A
<b>W</b>	<b>ANNEX W, SUMMATION OF TOUCH CURRENTS</b>		N/A
W.1	Touch current from electronic circuits	Not connected to TNV circuit	N/A
W.1.1	Floating circuits		N/A
W.1.2	Earthed circuits		N/A
W.2	Interconnection of several equipments		N/A
W.2.1	Isolation		N/A
W.2.2	Common return, isolated from earth		N/A
W.2.3	Common return, connected to protective earth		N/A
<b>X</b>	<b>ANNEX X, MAXIMUM HEATING EFFECT IN TRANSFORMER TESTS (see clause C.1)</b>		N/A
X.1	Determination of maximum input current		N/A
X.2	Overload test procedure		N/A
<b>Y</b>	<b>ANNEX Y, ULTRAVIOLET LIGHT CONDITIONING TEST (see 4.3.13.3)</b>		N/A
Y.1	Test apparatus .....		N/A
Y.2	Mounting of test samples .....		N/A
Y.3	Carbon-arc light-exposure apparatus .....		N/A
Y.4	Xenon-arc light exposure apparatus .....		N/A

This report shall not be reproduced except in full, without the written approval of KES Co., Ltd.  
 The results shown in this test report refer only to the sample(s) tested unless otherwise stated.  
 The authenticity of the test report, contact shchoi@kes.co.kr



<b>IEC/EN 60950-1</b>			
Clause	Requirement + Test	Result - Remark	Verdict
<b>Z</b>	<b>ANNEX Z, OVERVOLTAGE CATEGORIES (see 2.10.3.2 and Clause G.2)</b>		N/A
<b>AA</b>	<b>ANNEX AA, MANDREL TEST (see 2.10.5.8)</b>		N/A
<b>BB</b>	<b>ANNEX BB, CHANGES IN THE SECOND EDITION</b>		—
<b>CC</b>	<b>ANNEX CC, Evaluation of integrated circuit (IC) current limiters</b>		N/A
CC.1	General		N/A
CC.2	Test program 1.....:		N/A
CC.3	Test program 2.....:		N/A
CC.4	Test program 3.....:		N/A
CC.5	Compliance.....:		N/A
<b>DD</b>	<b>ANNEX DD, Requirements for the mounting means of rack-mounted equipment</b>		N/A
DD.1	General		N/A
DD.2	Mechanical strength test, variable N.....:		N/A
DD.3	Mechanical strength test, 250N, including end stops.....:		N/A
DD.4	Compliance.....:		N/A
<b>EE</b>	<b>ANNEX EE, Household and home/office document/media shredders</b>		N/A
EE.1	General		N/A
EE.2	Markings and instructions		N/A
	Use of markings or symbols.....:		N/A
	Information of user instructions, maintenance and/or servicing instructions.....:		N/A
EE.3	Inadvertent reactivation test.....:		N/A
EE.4	Disconnection of power to hazardous moving parts:		N/A
	Use of markings or symbols.....:		N/A
EE.5	Protection against hazardous moving parts		N/A
	Test with test finger (Figure 2A) .....		N/A
	Test with wedge probe (Figure EE1 and EE2) .....		N/A

This report shall not be reproduced except in full, without the written approval of KES Co., Ltd.  
 The results shown in this test report refer only to the sample(s) tested unless otherwise stated.  
 The authenticity of the test report, contact shchoi@kes.co.kr





<b>IEC/EN 60950-1</b>					
Clause	Requirement + Test	Result - Remark			Verdict
<b>1.5.1</b>	<b>TABLE: List of critical components</b>				<b>P</b>
Object/part No.	Manufacturer/ trademark	Type/model	Technical data	Standard (Edition / year)	Mark(s) of conformity <sup>1)</sup>
DC input port (CN8)	YEON HO ELECTRONICS CO., LTD	SMAW420 series (wafer)	AC/DC 600 V, AC/DC 9 A	UL 1977, EN 60950-1	UL (E108706), Tested in equipment
HDD (Optional)	Western Digital	WD10JUCT	DC 5 V, 0.55 A, 1 TB	EN 60950-1	CE, TUV-Rh
Alt.)	Interchangeable	Interchangeable	DC 5 V, 0.55 A, 1 TB	EN 60950-1	CE
DC Fan	NMB	04010SS-05N- AT	DC 5 V, 0.23 A	EN 60950-1	Tested in equipment
Lithium Rechargeable Battery_ button (BAT1)	SEIKO	MS621T	Nominal Voltage: 3 V, Nominal Capacity: 3.0 mAh	UL 1642	UL (MH15628)
HDD Case	Interchangeable	Interchangeable	Metal, Min. 1.5 mm	EN 60950-1	Tested in equipment
PCB	EXPRESS ELECTRONICS LTD	14MV0	V-0, 130 °C	UL 796	UL (E157925)
Alt.)	Interchangeable	Interchangeable	V-0, 130 °C	UL 796	UL
Enclosure	Interchangeable	Interchangeable	Metal, Min. 1.0 mm	EN 60950-1	Tested in equipment
Supplementary information: <sup>1)</sup> Provided evidence ensures the agreed level of compliance. See OD-CB2039.					

This report shall not be reproduced except in full, without the written approval of KES Co., Ltd.  
 The results shown in this test report refer only to the sample(s) tested unless otherwise stated.  
 The authenticity of the test report, contact shchoi@kes.co.kr



IEC/EN 60950-1			
Clause	Requirement + Test	Result - Remark	Verdict
<b>1.5.1</b>	<b>TABLE: Opto Electronic Devices</b>		N/A
Manufacturer .....			
Type.....			
Separately tested.....			
Bridging insulation .....			
External creepage distance .....			
Internal creepage distance .....			
Distance through insulation .....			
Tested under the following conditions .....			
Input.....			
Output.....			
supplementary information:			

1.6.2	TABLE: Electrical data (in normal conditions)					P
U (V)	I (A)	Irated (A)	P (W)	Fuse #	Ifuse (A)	Condition/status
9	6.19	13.5	55.71	N/A	N/A	Maximum normal load conditions
12	4.58		54.94	N/A	N/A	
36	1.53		55.03	N/A	N/A	
Supplementary information:						

This report shall not be reproduced except in full, without the written approval of KES Co., Ltd.  
 The results shown in this test report refer only to the sample(s) tested unless otherwise stated.  
 The authenticity of the test report, contact shchoi@kes.co.kr



IEC/EN 60950-1				
Clause	Requirement + Test	Result - Remark		Verdict
<b>2.1.1.5 c) 1)</b>	<b>TABLE: max. V, A, VA test</b>			N/A
Voltage (rated) (V)	Current (rated) (A)	Voltage (max.) (V)	Current (max.) (A)	VA (max.) (VA)
supplementary information:				
<b>2.1.1.5 c) 2)</b>	<b>TABLE: stored energy</b>			N/A
Capacitance C (μF)	Voltage U (V)	Energy E (J)		
supplementary information:				
<b>2.2</b>	<b>TABLE: evaluation of voltage limiting components in SELV circuits</b>			N/A
Component (measured between)		Max. voltage (V) (normal operation)		Voltage Limiting Components
		V peak	V d.c.	
Fault test performed on voltage limiting components		Voltage measured (V) in SELV circuits (V peak or V d.c.)		
supplementary information:				

This report shall not be reproduced except in full, without the written approval of KES Co., Ltd.  
 The results shown in this test report refer only to the sample(s) tested unless otherwise stated.  
 The authenticity of the test report, contact shchoi@kes.co.kr



IEC/EN 60950-1						
Clause	Requirement + Test	Result - Remark	Verdict			
<b>2.5</b>	<b>TABLE: limited power sources</b>		P			
Circuit output tested: Between pin 1 and GND on the front USB 2.0 port (JK5)						
Measured Uoc (V) with all load circuits disconnected: 5.06 V						
Components	Test condition (Single fault)	Uoc (V)	Isc (A)		VA	
			Meas.	Limit	Meas.	Limit
-	Normal	5.06	5	8	19.7	100
IC10	Short (pin2-pin5)	5.06	5	8	18.7	100
	Short (pin3-pin5)	0	0	8	0	100
	Short (pin2-pin4)	5.06	5	8	19.8	100
	Short (pin3-pin4)	5.06	5	8	19.8	100
Circuit output tested: Between pin 1 and GND on the front USB 2.0 port (JK1)						
Measured Uoc (V) with all load circuits disconnected: 5.06 V						
Components	Test condition (Single fault)	Uoc (V)	Isc (A)		VA	
			Meas.	Limit	Meas.	Limit
-	Normal	5.06	2	8	9.09	100
U17	Short (pin1-pin5)	5.06	2	8	9.09	100
	Short (pin2-pin5)	5.06	2	8	9.10	100
	Short (pin3-pin5)	5.06	2	8	9.10	100
	Short (pin4-pin5)	5.06	2	8	9.10	100
	Short (pin1-pin6)	5.06	2	8	9.11	100
	Short (pin2-pin6)	5.06	2	8	9.11	100
	Short (pin3-pin6)	0	0	8	0	100
	Short (pin4-pin6)	5.06	2	8	9.11	100
	Short (pin1-pin7)	0	0	8	0	100
	Short (pin2-pin7)	5.06	7	8	12.21	100
	Short (pin3-pin7)	1.36	0	8	0	100
	Short (pin4-pin7)	5.06	2	8	9.11	100
	Short (pin1-pin8)	0	0	8	0	100
	Short (pin2-pin8)	5.06	2	8	9.11	100
	Short (pin3-pin8)	5.06	2	8	9.11	100
	Short (pin4-pin8)	5.06	2	8	9.11	100

This report shall not be reproduced except in full, without the written approval of KES Co., Ltd.  
 The results shown in this test report refer only to the sample(s) tested unless otherwise stated.  
 The authenticity of the test report, contact shchoi@kes.co.kr



IEC/EN 60950-1						
Clause	Requirement + Test	Result - Remark			Verdict	
Circuit output tested: Between pin 1 and GND on the Rear USB 2.0 port (JK2)						
Measured Uoc (V) with all load circuits disconnected: 5.06 V						
Components	Test condition (Single fault)	Uoc (V)	I <sub>sc</sub> (A)		VA	
			Meas.	Limit	Meas.	Limit
-	Normal	5.06	3	8	12.99	100
IC8	Short (pin2-pin4)	0	0	8	0	100
	Short (pin3-pin4)	5.06	3	8	12.48	100
	Short (pin2-pin6)	5.06	4	8	15.39	100
	Short (pin3-pin6)	5.06	4	8	15.36	100
Circuit output tested: Between pin 15 and GND on the HDMI port (CN12)						
Measured Uoc (V) with all load circuits disconnected: 4.75 V						
Components	Test condition (Single fault)	Uoc (V)	I <sub>sc</sub> (A)		VA	
			Meas.	Limit	Meas.	Limit
-	Normal	4.87	0	8	0	100
D19	Short (pin1-pin6)	0	0	8	0	100
	Short (pin3-pin6)	4.88	0	8	0	100
	Short (pin4-pin6)	4.84	0	8	0	100
	Short (pin1-pin8)	0	0	8	0	100
	Short (pin3-pin8)	0	0	8	0	100
	Short (pin4-pin8)	4.87	0	8	0	100
	Short (pin1-pin9)	4.74	0	8	0	100
	Short (pin3-pin9)	4.84	0	8	0	100
	Short (pin4-pin9)	4.75	0	8	0	100
Circuit output tested: Between pin 16 and GND on the HDMI port (CN12)						
Measured Uoc (V) with all load circuits disconnected: 4.75 V						
Components	Test condition (Single fault)	Uoc (V)	I <sub>sc</sub> (A)		VA	
			Meas.	Limit	Meas.	Limit
D19	Short (pin1-pin6)	0	0	8	0	100
	Short (pin3-pin6)	4.95	1	8	2.50	100
	Short (pin4-pin6)	4.66	0	8	0	100
	Short (pin1-pin8)	4.75	0	8	0	100
	Short (pin3-pin8)	0	0	8	0	100
	Short (pin4-pin8)	0	0	8	0	100
	Short (pin1-pin9)	4.75	0	8	0	100
	Short (pin3-pin9)	4.88	0	8	0	100
	Short (pin4-pin9)	4.88	0	8	0	100

This report shall not be reproduced except in full, without the written approval of KES Co., Ltd.  
 The results shown in this test report refer only to the sample(s) tested unless otherwise stated.  
 The authenticity of the test report, contact shchoi@kes.co.kr



IEC/EN 60950-1						
Clause	Requirement + Test	Result - Remark			Verdict	
Circuit output tested: Between pin 2 and GND on the CONTROL BOX port (CN18) Measured Uoc (V) with all load circuits disconnected: 1.65 V						
Components	Test condition (Single fault)	Uoc (V)	I <sub>sc</sub> (A)		VA	
			Meas.	Limit	Meas.	Limit
-	Normal	1.65	0	8	0	100
Circuit output tested: Between pin 5 and GND on the CONTROL BOX port (CN18) Measured Uoc (V) with all load circuits disconnected: 0.56 V						
-	Normal	0.56	0	8	0	100
Circuit output tested: Between pin 7 and GND on the CONTROL BOX port (CN18) Measured Uoc (V) with all load circuits disconnected: 3.19 V						
-	Normal	3.19	0	8	0	100
Circuit output tested: Between pin 1 and GND on the GPS port (CN10) Measured Uoc (V) with all load circuits disconnected: 0.57 V						
Components	Test condition (Single fault)	Uoc (V)	I <sub>sc</sub> (A)		VA	
			Meas.	Limit	Meas.	Limit
-	Normal	0.57	0	8	0	100
Circuit output tested: Between pin 4 and GND on the GPS port (CN10) Measured Uoc (V) with all load circuits disconnected: 5.04 V						
-	Normal	5.04	6	8	15.48	100
Circuit output tested: Between pin2 and GND on the ALARM IN port (CN20) Measured Uoc (V) with all load circuits disconnected: 2.64 V						
Components	Test condition (Single fault)	Uoc (V)	I <sub>sc</sub> (A)		VA	
			Meas.	Limit	Meas.	Limit
-	Normal	2.64	0	8	0	100
Circuit output tested: Between pin4 and GND on the ALARM IN port (CN20) Measured Uoc (V) with all load circuits disconnected: 2.65 V						
-	Normal	2.65	0	8	0	100
Circuit output tested: Between pin6 and GND on the ALARM IN port (CN20) Measured Uoc (V) with all load circuits disconnected: 2.63 V						
-	Normal	2.63	0	8	0	100
Circuit output tested: Between pin7 and GND on the ALARM IN port (CN20) Measured Uoc (V) with all load circuits disconnected: 2.66 V						
-	Normal	2.66	0	8	0	100
Circuit output tested: Between pin8 and GND on the ALARM IN port (CN20) Measured Uoc (V) with all load circuits disconnected: 2.67 V						
-	Normal	2.67	0	8	0	100

This report shall not be reproduced except in full, without the written approval of KES Co., Ltd.  
 The results shown in this test report refer only to the sample(s) tested unless otherwise stated.  
 The authenticity of the test report, contact shchoi@kes.co.kr



IEC/EN 60950-1						
Clause	Requirement + Test	Result - Remark			Verdict	
Circuit output tested: Between pin2 and GND on the RESERVED port (CN14) Measured Uoc (V) with all load circuits disconnected: 0.56 V						
Components	Test condition (Single fault)	Uoc (V)	I <sub>sc</sub> (A)		VA	
			Meas.	Limit	Meas.	Limit
-	Normal	0.56	0	8	0	100
Circuit output tested: Between pin4 and GND on the RESERVED port (CN14) Measured Uoc (V) with all load circuits disconnected: 3.30 V						
-	Normal	3.30	0	8	0	100
Circuit output tested: Between pin1 and GND on the PoE port1 (CN3) Measured Uoc (V) with all load circuits disconnected: 32.27 V						
Components	Test condition (Single fault)	Uoc (V)	I <sub>sc</sub> (A)		VA	
			Meas.	Limit	Meas.	Limit
-	Normal	32.27	0	4.6 <sup>3)</sup>	0	100
Circuit output tested: Between pin2 and GND on the PoE port1 (CN3) Measured Uoc (V) with all load circuits disconnected: 31.29 V						
-	Normal	31.29	0	4.8 <sup>3)</sup>	0	100
Circuit output tested: Between pin6 and GND on the PoE port1 (CN3) Measured Uoc (V) with all load circuits disconnected: 54.16 V						
-	Normal	54.16	2	2.8 <sup>3)</sup>	88.62	100
Circuit output tested: Between pin3 and GND on the PoE port1 (CN3) Measured Uoc (V) with all load circuits disconnected: 54.15 V						
-	Normal <sup>1)</sup>	54.15	2	2.8 <sup>3)</sup>	86.60	100
Circuit output tested: Between pin3 and GND on the PoE port5 (CN2) Measured Uoc (V) with all load circuits disconnected: 32.25 V						
-	Normal	32.35	0	4.64 <sup>3)</sup>	0	100
Circuit output tested: Between pin7 and GND on the PoE port5 (CN2) Measured Uoc (V) with all load circuits disconnected: 32.34 V						
-	Normal	32.34	0	4.64 <sup>3)</sup>	0	100
Circuit output tested: Between pin5 and GND on the PoE port5 (CN2) Measured Uoc (V) with all load circuits disconnected: 32.34 V						
-	Normal	32.34	0	4.64 <sup>3)</sup>	0	100
Circuit output tested: Between pin8 and GND on the PoE port5 (CN2) Measured Uoc (V) with all load circuits disconnected: 54.21 V						
-	Normal <sup>2)</sup>	54.21	4	2.77 <sup>3)</sup>	205.92 <sup>4)</sup>	100
Supplementary information:						
<sup>1)</sup> When the maximum load is 3 A, parts T22 is damaged, no fire and No hazard. <sup>2)</sup> When the maximum load is 5 A, parts T24 is damaged, no fire and No hazard. <sup>3)</sup> Calculation formula Calculated value at 150/Uoc. <sup>4)</sup> LPS is not satisfied. (see the summary of testing).						

This report shall not be reproduced except in full, without the written approval of KES Co., Ltd.  
 The results shown in this test report refer only to the sample(s) tested unless otherwise stated.  
 The authenticity of the test report, contact shchoi@kes.co.kr



IEC/EN 60950-1			
Clause	Requirement + Test	Result - Remark	Verdict

<b>2.10.2</b>	<b>Table: working voltage measurement</b>			N/A
Location	RMS voltage (V)	Peak voltage (V)	Comments	
supplementary information:				

<b>2.10.3 and 2.10.4</b>	<b>TABLE: Clearance and creepage distance measurements</b>						N/A
Clearance (cl) and creepage distance (cr) at/of/between:	U peak (V)	U r.m.s. (V)	Required cl (mm)	cl (mm)	Required cr (mm)	cr (mm)	
Functional:							
Basic/supplementary:							
Reinforced:							
Supplementary information:							

<b>2.10.5</b>	<b>TABLE: Distance through insulation measurements</b>						N/A
Distance through insulation (DTI) at/of:	U peak (V)	U rms (V)	Test voltage (V)	Required DTI (mm)	DTI (mm)		
Supplementary information:							

This report shall not be reproduced except in full, without the written approval of KES Co., Ltd.  
 The results shown in this test report refer only to the sample(s) tested unless otherwise stated.  
 The authenticity of the test report, contact shchoi@kes.co.kr





IEC/EN 60950-1										
Clause	Requirement + Test			Result - Remark				Verdict		
<b>4.3.8</b>	<b>TABLE: Batteries</b>								P	
The tests of 4.3.8 are applicable only when appropriate battery data is not available				(see appended table 1.5.1)				P		
Is it possible to install the battery in a reverse polarity position?								N/A		
	Non-rechargeable batteries			Rechargeable batteries						
	Discharging (mA)		Un-intentional charging (mA)	Charging (mA)		Discharging (mA)		Reversed charging		
	Meas. current	Manuf. Specs.		Meas. current	Manuf. Specs.	Meas. current	Manuf. Specs.	Meas. current	Manuf. Specs.	
Max. current during normal condition	-	-	-	0.02	0.100	0.01	0.015	-	-	
Max. current during fault condition <sup>1)</sup>	-	-	-	0.15	-	1.20	-	-	-	
Max. current during fault condition <sup>2)</sup>	-	-	-	0.13	-	0.02	-	-	-	
1) D4, 2) R1										
Test results:								Verdict		
- Chemical leaks				No chemical leaks				P		
- Explosion of the battery				No explosion				P		
- Emission of flame or expulsion of molten metal				No				P		
- Electric strength tests of equipment after completion of tests								N/A		
Supplementary information:										

This report shall not be reproduced except in full, without the written approval of KES Co., Ltd.  
 The results shown in this test report refer only to the sample(s) tested unless otherwise stated.  
 The authenticity of the test report, contact shchoi@kes.co.kr

IEC/EN 60950-1			
Clause	Requirement + Test	Result - Remark	Verdict

<b>4.3.8</b>	<b>TABLE: Batteries</b>		<b>P</b>
--------------	-------------------------	--	----------

Battery category ..... : Lithium Rechargeable Battery\_ button  
 Manufacturer ..... : SEIKO  
 Type / model..... : MS621T  
 Voltage ..... : DC 3 V  
 Capacity ..... : 3.0 mAh  
 Tested and Certified by (incl. Ref. No.)..... : UL (MH15628)

Circuit protection diagram:

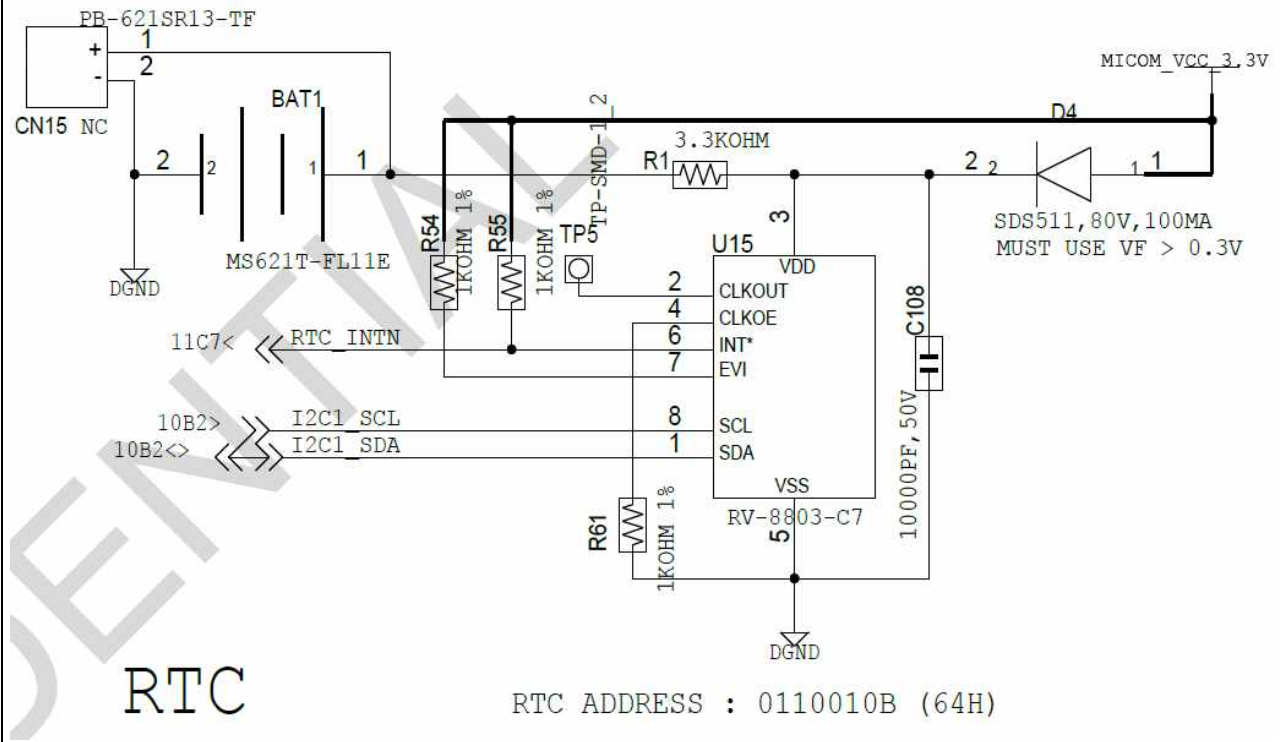

MARKINGS AND INSTRUCTIONS (1.7.13)	
Location of replaceable battery	N/A
Language(s) .....	N/A
Close to the battery .....	N/A
In the servicing instructions .....	N/A
In the operating instructions .....	N/A

This report shall not be reproduced except in full, without the written approval of KES Co., Ltd.  
 The results shown in this test report refer only to the sample(s) tested unless otherwise stated.  
 The authenticity of the test report, contact shchoi@kes.co.kr



IEC/EN 60950-1								
Clause	Requirement + Test	Result - Remark				Verdict		
<b>4.5</b>	<b>TABLE: Thermal requirements</b>					P		
	Supply voltage (V) ...:	9 V		9 V		—		
	Ambient T <sub>min</sub> (°C) .....	-		-		—		
	Ambient T <sub>max</sub> (°C) .....	See below		-		—		
Maximum measured temperature T of part/at::		T (°C) *)		T (°C) **)		Allowed T <sub>max</sub> (°C)		
	1. Ambient	23.9		40.0		-		
	2. HDD body	32.8		48.9		-		
	3. DC Fan body	32.1		48.2		-		
	4. PCB near T20	36.2		52.3		130		
	5. PCB near T24	34.8		50.9		130		
	6. PCB near T22	39.3		55.4		130		
	7. PCB near CN8	33.4		49.5		130		
	8. PCB near CN2 (PoE board)	28.5		44.6		130		
	9. PCB near CN4 (PoE board)	27.6		43.7		130		
	10. PCB near CN3 (PoE board)	30.2		46.3		130		
	11. BAT1 body	33.8		49.9		85		
	12. Enclosure near PoE port	26.0		42.1		70		
	13. Enclosure near DC input port	26.2		42.3		70		
	14. Enclosure near USB 2.0 (Rear side)	27.4		43.5		70		
	15. Enclosure near USB 2.0 (Front side)	29.7		45.8		70		
	16. Top enclosure	26.8		42.9		70		
Supplementary information:								
*) T = Measured temperature.								
**) T = T - Tamb + Tma (T <sub>ma</sub> : 40 °C)								
Temperature T of winding:		t <sub>1</sub> (°C)	R <sub>1</sub> (Ω)	t <sub>2</sub> (°C)	R <sub>2</sub> (Ω)	T (°C)	Allowed T <sub>max</sub> (°C)	Insulation class
Supplementary information:								

This report shall not be reproduced except in full, without the written approval of KES Co., Ltd.  
 The results shown in this test report refer only to the sample(s) tested unless otherwise stated.  
 The authenticity of the test report, contact shchoi@kes.co.kr



IEC/EN 60950-1								
Clause	Requirement + Test	Result - Remark				Verdict		
<b>4.5</b>	<b>TABLE: Thermal requirements</b>					P		
	Supply voltage (V) ...:	36 V	36 V		—			
	Ambient T <sub>min</sub> (°C) .....	-	-		—			
	Ambient T <sub>max</sub> (°C) .....	See below	-		—			
Maximum measured temperature T of part/at::		T (°C) *)	T (°C) **)		Allowed T <sub>max</sub> (°C)			
1. Ambient		22.3	40.0		-			
2. HDD body		31.2	48.9		-			
3. DC Fan body		30.3	48.0		-			
4. PCB near T20		34.2	51.9		130			
5. PCB near T24		33.2	50.9		130			
6. PCB near T22		38.4	56.1		130			
7. PCB near CN8		30.7	48.4		130			
8. PCB near CN2 (PoE board)		26.9	44.6		130			
9. PCB near CN4 (PoE board)		25.8	43.5		130			
10. PCB near CN3 (PoE board)		28.5	46.2		130			
11. BAT1 body		32.2	49.9		85			
12. Enclosure near PoE port		23.8	41.5		70			
13. Enclosure near DC input port		24.2	41.9		70			
14. Enclosure near USB 2.0 (Rear side)		25.4	43.1		70			
15. Enclosure near USB 2.0 (Front side)		28.0	45.7		70			
16. Top enclosure		24.6	42.3		70			
Supplementary information:								
*) T = Measured temperature.								
**) T = T - Tamb + Tma (T <sub>ma</sub> : 40 °C)								
Temperature T of winding:		t <sub>1</sub> (°C)	R <sub>1</sub> (Ω)	t <sub>2</sub> (°C)	R <sub>2</sub> (Ω)	T (°C)	Allowed T <sub>max</sub> (°C)	Insulation class
Supplementary information:								

This report shall not be reproduced except in full, without the written approval of KES Co., Ltd.  
 The results shown in this test report refer only to the sample(s) tested unless otherwise stated.  
 The authenticity of the test report, contact shchoi@kes.co.kr



IEC/EN 60950-1			
Clause	Requirement + Test	Result - Remark	Verdict

<b>4.5.5</b>	<b>TABLE: Ball pressure test of thermoplastic parts</b>		N/A
	Allowed impression diameter (mm) ..... : ≤ 2 mm		—
Part	Test temperature (°C)	Impression diameter (mm)	
Supplementary information:			

<b>4.7</b>	<b>TABLE: Resistance to fire</b>				N/A
Part	Manufacturer of material	Type of material	Thickness (mm)	Flammability class	Evidence
Supplementary information:					

<b>5.1</b>	<b>TABLE: Touch current measurement</b>			N/A
Measured between:	Measured (mA)	Limit (mA)	Comments/conditions	
Supplementary information:				

<b>5.2</b>	<b>TABLE: Electric strength tests, impulse tests and voltage surge tests</b>			N/A
Test voltage applied between:	Voltage shape (AC, DC, impulse, surge)	Test voltage (V)	Breakdown Yes / No	
Functional:				
Basic/supplementary:				
Reinforced:				
Supplementary information:				

This report shall not be reproduced except in full, without the written approval of KES Co., Ltd.  
 The results shown in this test report refer only to the sample(s) tested unless otherwise stated.  
 The authenticity of the test report, contact shchoi@kes.co.kr



IEC/EN 60950-1						
Clause	Requirement + Test	Result - Remark				Verdict
<b>5.3</b>	<b>TABLE: Fault condition tests</b>					<b>P</b>
	Ambient temperature (°C) .....	15 °C - 35 °C				—
	Power source for EUT: Manufacturer, model/type, output rating .....	N/A				—
Component No.	Fault	Supply voltage (V)	Test time	Fuse #	Fuse current (A)	Observation
1. Unit	DC fan lock	9	4 h 58 min	-	-	Fault input current at 6.29 A, and stabilized. No fire. No hazard. (See Table 5.3 appended with respect to temperature)
2. Unit	DC fan lock	12	1 h 51 min	-	-	Fault input current at 4.62 A, and stabilized. No fire. No hazard. (See Table 5.3 appended with respect to temperature)
3. Unit	DC fan lock	36	1 h 28 min	-	-	Fault input current at 1.55 A, and stabilized. No fire. No hazard. (See Table 4.5 appended with respect to temperature)
4. DC fan	lock	5	7 h 49 min	-	-	Fault input current at 0.35 A. Ambient: 23.5 °C, DC fan body: 30.7 °C, No fire and No hazard.
Supplementary information: Tested with an AC / DC adaptor connected. S-c=short circuit, O-c=open circuit, O-l=overload						

This report shall not be reproduced except in full, without the written approval of KES Co., Ltd.  
 The results shown in this test report refer only to the sample(s) tested unless otherwise stated.  
 The authenticity of the test report, contact shchoi@kes.co.kr



IEC/EN 60950-1			
Clause	Requirement + Test	Result - Remark	Verdict
<b>5.3</b>	<b>TABLE: Thermal requirements</b>		P
	Supply voltage (V) .....	9 V (DC Fan lock)	9 V (DC Fan lock)
	Ambient T <sub>min</sub> (°C) .....	-	-
	Ambient T <sub>max</sub> (°C) .....	See below	-
Maximum measured temperature T of part/at:		T (°C) *)	T (°C) **)
1. Ambient		23.9	40.0
2. HDD body		54.8	70.9
3. DC Fan body		39.1	55.2
4. PCB near T20		49.7	65.8
5. PCB near T24		49.5	65.6
6. PCB near T22		50.7	66.8
7. PCB near CN8		44.8	60.9
8. PCB near CN2 (PoE board)		40.3	56.4
9. PCB near CN4 (PoE board)		39.0	55.1
10. PCB near CN3 (PoE board)		40.3	56.4
11. BAT1 body		41.9	58.0
12. Enclosure near PoE port		31.6	47.7
13. Enclosure near DC input port		32.0	48.1
14. Enclosure near USB 2.0 (Rear side)		36.8	52.9
15. Enclosure near USB 2.0 (Front side)		37.0	53.1
16. Top enclosure		30.3	46.4
Supplementary information:			
*) T = Measured temperature.			
**) T = T - Tamb + Tma (T <sub>ma</sub> : 40 °C)			

This report shall not be reproduced except in full, without the written approval of KES Co., Ltd.  
 The results shown in this test report refer only to the sample(s) tested unless otherwise stated.  
 The authenticity of the test report, contact shchoi@kes.co.kr



IEC/EN 60950-1			
Clause	Requirement + Test	Result - Remark	Verdict
<b>5.3</b>	<b>TABLE: Thermal requirements</b>		P
	Supply voltage (V) .....	36 V (DC Fan lock)	36 V (DC Fan lock)
	Ambient T <sub>min</sub> (°C) .....	-	-
	Ambient T <sub>max</sub> (°C) .....	See below	-
	Maximum measured temperature T of part/at:	T (°C) *)	T (°C) **)
	1. Ambient	23.3	40.0
	2. HDD body	54.3	71.0
	3. DC Fan body	38.5	55.2
	4. PCB near T20	49.1	65.8
	5. PCB near T24	48.7	65.4
	6. PCB near T22	50.8	67.5
	7. PCB near CN8	43.0	59.7
	8. PCB near CN2 (PoE board)	39.4	56.1
	9. PCB near CN4 (PoE board)	38.2	54.9
	10. PCB near CN3 (PoE board)	39.5	56.2
	11. BAT1 body	41.1	57.8
	12. Enclosure near PoE port	31.0	47.7
	13. Enclosure near DC input port	32.1	48.8
	14. Enclosure near USB 2.0 (Rear side)	35.6	52.3
	15. Enclosure near USB 2.0 (Front side)	36.4	53.1
	16. Top enclosure	29.4	46.1
Supplementary information:			
*) T = Measured temperature.			
**) T = T - Tamb + Tma (T <sub>ma</sub> : 40 °C)			

This report shall not be reproduced except in full, without the written approval of KES Co., Ltd.  
 The results shown in this test report refer only to the sample(s) tested unless otherwise stated.  
 The authenticity of the test report, contact shchoi@kes.co.kr





IEC/EN 60950-1							
Clause	Requirement + Test				Result - Remark		Verdict
<b>C.2</b>	<b>TABLE: Transformers</b>						N/A
Loc.	Tested insulation	Working voltage peak / V	Working voltage rms / V	Required electric strength	Required clearance / mm	Required creepage distance / mm	Required distance thr. insul.
		(2.10.2)	(2.10.2)	(5.2)	(2.10.3)	(2.10.4)	(2.10.5)
Loc.	Tested insulation			Test voltage/ V	Measure d clearance / mm	Measured creepage dist./ mm	Measured distance thr. insul. / mm; number of layers
supplementary information:							
<b>C.2</b>	<b>TABLE: Transformers</b>						N/A
Transformer :							

This report shall not be reproduced except in full, without the written approval of KES Co., Ltd.  
 The results shown in this test report refer only to the sample(s) tested unless otherwise stated.  
 The authenticity of the test report, contact shchoi@kes.co.kr



<b>IEC/EN 60950-1 ATTACHMENT 1</b>			
Clause	Requirement + Test	Result - Remark	Verdict

<p><b>ATTCHMENT TO TEST REPORT IEC 60950-1</b>  <b>EUROPEAN GROUP DIFFERENCES AND NATIONAL DIFFERENCES</b>          Information technology equipment – Safety –  <b>PART 1: GENERAL REQUIREMENTS</b></p>
<p><b>Differences according to</b> .....: EN 60950-1:2006/A11:2009/A1:2010/A12:2011/A2:2013</p>
<p><b>Attachment Form No.</b> .....: EU_GD_IEC60950_1F</p>
<p><b>Attachment Originator</b>.....: SGS Fimko Ltd</p>
<p><b>Master Attachment</b> .....: Date 2014-02</p>
<p><b>Copyright © 2014 IEC System for Conformity Testing and Certification of Electrical Equipment (IECEE), Geneva, Switzerland. All rights reserved.</b></p>

<b>EN 60950-1:2006/A11:2009/A1:2010/A12:2011/A2:2013 – CENELEC COMMON MODIFICATIONS</b>
---

<b>IEC 60950-1, GROUP DIFFERENCES (CENELEC common modifications EN)</b>			
Clause	Requirement + Test	Result - Remark	Verdict
	Clauses, subclauses, notes, tables and figures which are additional to those in IEC60950-1 and it's amendmets are prefixed "Z"		-
Contents  (A2:2013)	Add the following annexes: Annex ZA (normative)                      Normative references to international publications with their corresponding European publications Annex ZB (normative)                      Special national conditions Annex ZD (informative)                      IEC and CENELEC code designations for flexible cords		-
General	Delete all the "country" notes in the reference document (IEC 60950-1:2005) according to the following list: 1.4.8 Note 2      1.5.1      Note 2 & 3      1.5.7.1      Note 1.5.8 Note 2      1.5.9.4      Note      1.7.2.1      Note 4, 5 & 6 2.2.3 Note      2.2.4      Note      2.3.2      Note 2.3.2.1 Note 2      2.3.4      Note 2      2.6.3.3      Note 2 & 3 2.7.1 Note      2.10.3.2      Note 2      2.10.5.13      Note 3 3.2.1.1 Note      3.2.4      Note 3.      2.5.1      Note 2 4.3.6 Note 1 & 2      4.7      Note 4      4.7.2.2      Note 4.7.3.1 Note 2      5.1.7.1      Note 3 & 4      5.3.7      Note 1 6 Note 2 & 5      6.1.2.1      Note 2      6.1.2.2      Note 6.2.2 Note      6.2.2.1      Note 2      6.2.2.2      Note 7.1 Note 3      7.2      Note      7.3      Note 1 & 2 G.2.1 Note 2      Annex H      Note 2		-
General (A1:2010)	Delete all the "country" notes in the reference document (IEC 60950-1:2005/A1:2010) according to the following list: 1.5.7.1      Note                      6.1.2.1      Note 2 6.2.2.1      Note 2                      EE.3      Note		-

This report shall not be reproduced except in full, without the written approval of KES Co., Ltd.  
 The results shown in this test report refer only to the sample(s) tested unless otherwise stated.  
 The authenticity of the test report, contact shchoi@kes.co.kr



<b>IEC/EN 60950-1 ATTACHMENT 1</b>			
Clause	Requirement + Test	Result - Remark	Verdict
<b>IEC 60950-1, GROUP DIFFERENCES (CENELEC common modifications EN)</b>			
Clause	Requirement + Test	Result - Remark	Verdict
General (A2:2013)	Delete all the "country" notes in the reference document (IEC 60950-1:2005/A2:2013) according to the following list: 1.5.7.1 Note *                      6.1.2.1 Note 2 6.2.2.1 Note 2                      EE.3 Note * Note of secretary: Text of Common Modification remains unchanged.		-
1.1.1 (A1:2010)	<b>Replace</b> the text of NOTE 3 by the following. NOTE 3 The requirements of EN 60065 may also be used to meet safety requirements for multimedia equipment. See IEC Guide 112, Guide on the safety of multimedia equipment. For television sets EN 60065 applies.		-
1.3.Z1	Add the following subclause: 1.3.Z1 Exposure to excessive sound pressure The apparatus shall be so designed and constructed as to present no danger when used for its intended purpose, either in normal operating conditions or under fault conditions, particularly providing protection against exposure to excessive sound pressures from headphones or earphones. NOTE Z1 A new method of measurement is described in EN 50332-1, Sound system equipment: Headphones and earphones associated with portable audio equipment - Maximum sound pressure level measurement methodology and limit considerations - Part 1: General method for "one package equipment", and in EN 50332-2, Sound system equipment: Headphones and earphones associated with portable audio equipment - Maximum sound pressure level measurement methodology and limit considerations - Part 2: Guidelines to associate sets with headphones coming from different manufacturers.	This equipment is not portable audio equipment.	N/A
(A12:2011)	In EN 60950-1:2006/A12:2011 Delete the addition of 1.3.Z1 / EN 60950-1:2006 Delete the definition 1.2.3.Z1 / EN 60950-1:2006 /A1:2010	Considered	P
1.5.1  (Added info*)	Add the following NOTE: NOTE Z1 The use of certain substances in electrical and electronic equipment is restricted within the EU: see Directive 2002/95/EC. New Directive 2011/65/11 *	Considered	P
1.7.2.1 (A1:2010)	In addition, for a PORTABLE SOUND SYSTEM, the instructions shall include a warning that excessive sound pressure from earphones and headphones can cause hearing loss.	This equipment is not portable audio equipment.	N/A

This report shall not be reproduced except in full, without the written approval of KES Co., Ltd.  
 The results shown in this test report refer only to the sample(s) tested unless otherwise stated.  
 The authenticity of the test report, contact shchoi@kes.co.kr



<b>IEC/EN 60950-1 ATTACHMENT 1</b>			
Clause	Requirement + Test	Result - Remark	Verdict
1.7.2.1 A12.2011)	In EN 60950-1:2006/A12:2011 Delete NOTE Z1 and the addition for Portable Sound System. Add the following clause and annex to the existing standard and amendments.	This equipment is not portable audio equipment.	N/A
	<b>Zx Protection against excessive sound pressure from personal music players</b>		N/A
	<b>Zx.1 General</b> This sub-clause specifies requirements for protection against excessive sound pressure from personal music players that are closely coupled to the ear. It also specifies requirements for earphones and headphones intended for use with personal music players. A personal music player is a portable equipment for personal use, that: is designed to allow the user to listen to recorded or broadcast sound or video; and primarily uses headphones or earphones that can be worn in or on or around the ears; and allows the user to walk around while in use. NOTE 1 Examples are hand-held or body-worn portable CD players, MP3 audio players, mobile phones with MP3 type features, PDA's or similar equipment. A personal music player and earphones or headphones intended to be used with personal music players shall comply with the requirements of this sub-clause. The requirements in this sub-clause are valid for music or video mode only. The requirements do not apply: while the personal music player is connected to an external amplifier; or while the headphones or earphones are not used. NOTE 2 An external amplifier is an amplifier which is not part of the personal music player or the listening device, but which is intended to play the music as a standalone music player. The requirements do not apply to: hearing aid equipment and professional equipment; NOTE 3 Professional equipment is equipment sold through special sales channels. All products sold through normal electronics stores are considered not to be professional equipment.	This equipment is not portable audio equipment.	N/A

This report shall not be reproduced except in full, without the written approval of KES Co., Ltd.  
 The results shown in this test report refer only to the sample(s) tested unless otherwise stated.  
 The authenticity of the test report, contact shchoi@kes.co.kr



IEC/EN 60950-1 ATTACHMENT 1			
Clause	Requirement + Test	Result - Remark	Verdict
	<p>– analogue personal music players (personal music players without any kind of digital processing of the sound signal) that are brought to the market before the end of 2015.</p> <p>NOTE 4 This exemption has been allowed because this technology is falling out of use and it is expected that within a few years it will no longer exist. This exemption will not be extended to other technologies.</p> <p>For equipment which is clearly designed or intended for use by young children, the limits of EN 71-1 apply.</p>	This equipment is not portable audio equipment.	N/A
	<p><b>Zx.2 Equipment requirements</b></p> <p>No safety provision is required for equipment that complies with the following:</p> <ul style="list-style-type: none"><li>equipment provided as a package (personal music player with its listening device), where the acoustic output <math>L_{Aeq,T}</math> is <math>\leq 85</math> dBA measured while playing the fixed “programme simulation noise” as described in EN 50332-1; and</li><li>a personal music player provided with an analogue electrical output socket for a listening device, where the electrical output is <math>\leq 27</math> mV measured as described in EN 50332-2, while playing the fixed “programme simulation noise” as described in EN 50332-1.</li></ul> <p>NOTE 1 Wherever the term acoustic output is used in this clause, the 30 s A-weighted equivalent sound pressure level <math>L_{Aeq,T}</math> is meant. See also Zx.5 and Annex Zx.</p> <p>All other equipment shall:</p> <ul style="list-style-type: none"><li>a) protect the user from unintentional acoustic outputs exceeding those mentioned above; and</li><li>b) have a standard acoustic output level not exceeding those mentioned above, and automatically return to an output level not exceeding those mentioned above when the power is switched off; and</li></ul>	This equipment is not portable audio equipment.	N/A

This report shall not be reproduced except in full, without the written approval of KES Co., Ltd.  
The results shown in this test report refer only to the sample(s) tested unless otherwise stated.  
The authenticity of the test report, contact shchoi@kes.co.kr



<b>IEC/EN 60950-1 ATTACHMENT 1</b>			
Clause	Requirement + Test	Result - Remark	Verdict
	<p>c) provide a means to actively inform the user of the increased sound pressure when the equipment is operated with an acoustic output exceeding those mentioned above. Any means used shall be acknowledged by the user before activating a mode of operation which allows for an acoustic output exceeding those mentioned above. The acknowledgement does not need to be repeated more than once every 20 h of cumulative listening time; and</p> <p>NOTE 2 Examples of means include visual or audible signals. Action from the user is always required.</p> <p>NOTE 3 The 20 h listening time is the accumulative listening time, independent how often and how long the personal music player has been switched off.</p> <p>d) have a warning as specified in Zx.3; and</p> <p>e) not exceed the following:</p> <p style="margin-left: 20px;">1) equipment provided as a package (player with its listening device), the acoustic output shall be <math>\leq 100</math> dBA measured while playing the fixed "programme simulation noise" described in EN 50332-1; and</p> <p style="margin-left: 20px;">2) a personal music player provided with an analogue electrical output socket for a listening device, the electrical output shall be <math>\leq 150</math> mV measured as described in EN 50332-2, while playing the fixed "programme simulation noise" described in EN 50332-1.</p> <p>For music where the average sound pressure (long term <math>L_{Aeq,T}</math>) measured over the duration of the song is lower than the average produced by the programme simulation noise, the warning does not need to be given as long as the average sound pressure of the song is below the basic limit of 85 dBA. In this case T becomes the duration of the song.</p> <p>NOTE 4 Classical music typically has an average sound pressure (long term <math>L_{Aeq,T}</math>) which is much lower than the average programme simulation noise. Therefore, if the player is capable to analyse the song and compare it with the programme simulation noise, the warning does not need to be given as long as the average sound pressure of the song is below the basic limit of 85 dBA.</p> <p>For example, if the player is set with the programme simulation noise to 85 dBA, but the average music level of the song is only 65 dBA, there is no need to give a warning or ask an acknowledgement as long as the average sound level of the song is not above the basic limit of 85 dBA.</p>	<p>This equipment is not portable audio equipment.</p>	<p>N/A</p>

This report shall not be reproduced except in full, without the written approval of KES Co., Ltd.  
 The results shown in this test report refer only to the sample(s) tested unless otherwise stated.  
 The authenticity of the test report, contact shchoi@kes.co.kr

<b>IEC/EN 60950-1 ATTACHMENT 1</b>			
Clause	Requirement + Test	Result - Remark	Verdict
	<p><b>Zx.3 Warning</b>            The warning shall be placed on the equipment, or on the packaging, or in the instruction manual and shall consist of the following:            the symbol of Figure 1 with a minimum height of 5 mm; and            the following wording, or similar:            “To prevent possible hearing damage, do not listen at high volume levels for long periods.”</p> <div style="text-align: center;">  </div> <p style="text-align: center;"><b>Figure 1 – Warning label (IEC 60417-6044)</b></p> <p>Alternatively, the entire warning may be given through the equipment display during use, when the user is asked to acknowledge activation of the higher level.</p>	<p>This equipment is not portable audio equipment.</p>	N/A
	<p><b>Zx.4 Requirements for listening devices (headphones and earphones)</b></p>		N/A
	<p><b>Zx.4.1 Wired listening devices with analogue input</b>            With 94 dBA sound pressure output <math>L_{Aeq,T}</math>, the input voltage of the fixed “programme simulation noise” described in EN 50332-2 shall be <math>\geq 75</math> mV.             This requirement is applicable in any mode where the headphones can operate (active or passive), including any available setting (for example built-in volume level control).             NOTE The values of 94 dBA – 75 mV correspond with 85dBA – 27 mV and 100 dBA – 150 mV.</p>	<p>This equipment is not portable audio equipment.</p>	N/A

This report shall not be reproduced except in full, without the written approval of KES Co., Ltd.  
 The results shown in this test report refer only to the sample(s) tested unless otherwise stated.  
 The authenticity of the test report, contact shchoi@kes.co.kr



<b>IEC/EN 60950-1 ATTACHMENT 1</b>			
Clause	Requirement + Test	Result - Remark	Verdict
	<p><b>Zx.4.2 Wired listening devices with digital input</b>            With any playing device playing the fixed “programme simulation noise” described in EN 50332-1 (and respecting the digital interface standards, where a digital interface standard exists that specifies the equivalent acoustic level), the acoustic output <math>L_{Aeq,T}</math> of the listening device shall be <math>\leq 100</math> dBA.</p> <p>This requirement is applicable in any mode where the headphones can operate, including any available setting (for example built-in volume level control, additional sound feature like equalization, etc.).</p> <p>NOTE An example of a wired listening device with digital input is a USB headphone.</p>	This equipment is not portable audio equipment.	N/A
	<p><b>Zx.4.3 Wireless listening devices</b>            In wireless mode:            with any playing and transmitting device playing the fixed programme simulation noise described in EN 50332-1; and            respecting the wireless transmission standards, where an air interface standard exists that specifies the equivalent acoustic level; and            with volume and sound settings in the listening device (for example built-in volume level control, additional sound feature like equalization, etc.) set to the combination of positions that maximize the measured acoustic output for the abovementioned programme simulation noise, the acoustic output <math>L_{Aeq,T}</math> of the listening device shall be <math>\leq 100</math> dBA.</p> <p>NOTE An example of a wireless listening device is a Bluetooth headphone.</p>	This equipment is not portable audio equipment.	N/A
	<p><b>Zx.5 Measurement methods</b>            Measurements shall be made in accordance with EN 50332-1 or EN 50332-2 as applicable. Unless stated otherwise, the time interval T shall be 30 s.</p> <p>NOTE Test method for wireless equipment provided without listening device should be defined.</p>	This equipment is not portable audio equipment.	N/A

This report shall not be reproduced except in full, without the written approval of KES Co., Ltd.  
 The results shown in this test report refer only to the sample(s) tested unless otherwise stated.  
 The authenticity of the test report, contact shchoi@kes.co.kr





<b>IEC/EN 60950-1 ATTACHMENT 1</b>			
Clause	Requirement + Test	Result - Remark	Verdict
2.7.1	Replace the subclause as follows: <b>Basic requirements</b> To protect against excessive current, short-circuits and earth faults in PRIMARY CIRCUITS, protective devices shall be included either as integral parts of the equipment or as parts of the building installation, subject to the following, a), b) and c): a) except as detailed in b) and c), protective devices necessary to comply with the requirements of 5.3 shall be included as parts of the equipment; b) for components in series with the mains input to the equipment such as the supply cord, appliance coupler, r.f.i. filter and switch, short-circuit and earth fault protection may be provided by protective devices in the building installation;	Class III equipment	N/A
	c) it is permitted for PLUGGABLE EQUIPMENT TYPE B or PERMANENTLY CONNECTED EQUIPMENT, to rely on dedicated overcurrent and short-circuit protection in the building installation, provided that the means of protection, e.g. fuses or circuit breakers, is fully specified in the installation instructions.  If reliance is placed on protection in the building installation, the installation instructions shall so state, except that for PLUGGABLE EQUIPMENT TYPE A the building installation shall be regarded as providing protection in accordance with the rating of the wall socket outlet.		N/A
2.7.2	This subclause has been declared 'void'.	Considered	-
3.2.3	Delete the NOTE in Table 3A, and delete also in this table the conduit sizes in parentheses.	Class III equipment	N/A
3.2.5.1	Replace "60245 IEC 53" by "H05 RR-F"; "60227 IEC 52" by "H03 VV-F or H03 VVH2-F"; "60227 IEC 53" by "H05 VV-F or H05 VVH2-F2".  In Table 3B, replace the first four lines by the following: Up to and including 6   0,75 <sup>a)</sup>   Over 6 up to and including 10   (0,75) <sup>b)</sup> 1,0   Over 10 up to and including 16   (1,0) <sup>c)</sup> 1,5   In the conditions applicable to Table 3B delete the words "in some countries" in condition <sup>a)</sup> . In NOTE 1, applicable to Table 3B, delete the second sentence.	Class III equipment	N/A
3.2.5.1 (A2:2013)	NOTE Z1 The harmonised code designations corresponding to the IEC cord types are given in Annex ZD		N/A

This report shall not be reproduced except in full, without the written approval of KES Co., Ltd.  
 The results shown in this test report refer only to the sample(s) tested unless otherwise stated.  
 The authenticity of the test report, contact shchoi@kes.co.kr



<b>IEC/EN 60950-1 ATTACHMENT 1</b>			
Clause	Requirement + Test	Result - Remark	Verdict
3.3.4	In Table 3D, delete the fourth line: conductor sizes for 10 to 13 A, and replace with the following: Over 10 up to and including 16   1,5 to 2,5   1,5 to 4   Delete the fifth line: conductor sizes for 13 to 16 A	Class III equipment	N/A
4.3.13.6 (A1:2010)	Replace the existing NOTE by the following: NOTE Z1 Attention is drawn to: 1999/519/EC: Council Recommendation on the limitation of exposure of the general public to electromagnetic fields 0 Hz to 300 GHz, and 2006/25/EC: Directive on the minimum health and safety requirements regarding the exposure of workers to risks arising from physical agents (artificial optical radiation).		N/A
	Standards taking into account mentioned Recommendation and Directive which demonstrate compliance with the applicable EU Directive are indicated in the OJEC.		N/A
Annex H	Replace the last paragraph of this annex by: At any point 10 cm from the surface of the OPERATOR ACCESS AREA, the dose rate shall not exceed 1 µSv/h (0,1 mR/h) (see NOTE). Account is taken of the background level. Replace the notes as follows: NOTE These values appear in Directive 96/29/Euratom. Delete NOTE 2.		N/A
Bibliography	Additional EN standards.		—

<b>ZA</b>	<b>NORMATIVE REFERENCES TO INTERNATIONAL PUBLICATIONS WITH THEIR CORRESPONDING EUROPEAN PUBLICATIONS</b>	—
-----------	--	---

<b>ZB ANNEX (normative) SPECIAL NATIONAL CONDITIONS (EN)</b>			
Clause	Requirement + Test	Result - Remark	Verdict
1.2.4.1	In <b>Denmark</b> , certain types of Class I appliances (see 3.2.1.1) may be provided with a plug not establishing earthing conditions when inserted into Danish socket-outlets.	Class III equipment	N/A
1.2.13.14 (A11:2009)	In <b>Norway</b> and <b>Sweden</b> , for requirements see 1.7.2.1 and 7.3 of this annex.		N/A
1.5.7.1 (A11:2009)	In <b>Finland</b> , <b>Norway</b> and <b>Sweden</b> , resistors bridging BASIC INSULATION in CLASS I PLUGGABLE EQUIPMENT TYPE A must comply with the requirements in 1.5.7.1. In addition when a single resistor is used, the resistor must withstand the resistor test in 1.5.7.2.	No resistors bridging BASIC INSULATION in the equipment.	N/A

This report shall not be reproduced except in full, without the written approval of KES Co., Ltd.  
 The results shown in this test report refer only to the sample(s) tested unless otherwise stated.  
 The authenticity of the test report, contact shchoi@kes.co.kr



IEC/EN 60950-1 ATTACHMENT 1			
Clause	Requirement + Test	Result - Remark	Verdict
<b>ZB ANNEX (normative) SPECIAL NATIONAL CONDITIONS (EN)</b>			
Clause	Requirement + Test	Result - Remark	Verdict
1.5.8	In <b>Norway</b> , due to the IT power system used (see annex V, Figure V.7), capacitors are required to be rated for the applicable line-to-line voltage (230 V).	Class III equipment	N/A
1.5.9.4	In <b>Finland, Norway and Sweden</b> , the third dashed sentence is applicable only to equipment as defined in 6.1.2.2 of this annex.		N/A
1.7.2.1	In <b>Finland, Norway and Sweden</b> , CLASS I PLUGGABLE EQUIPMENT TYPE A intended for connection to other equipment or a network shall, if safety relies on connection to protective earth or if surge suppressors are connected between the network terminals and accessible parts, have a marking stating that the equipment must be connected to an earthed mains socket-outlet. The marking text in the applicable countries shall be as follows: In Finland: "Laitte on liitettävä suojakoskettimilla varustettuun pistorasiaan" In Norway: "Apparatet må tilkoples jordet stikkontakt" In Sweden: "Apparaten skall anslutas till jordat uttag"	Class III equipment	N/A

This report shall not be reproduced except in full, without the written approval of KES Co., Ltd.  
The results shown in this test report refer only to the sample(s) tested unless otherwise stated.  
The authenticity of the test report, contact shchoi@kes.co.kr



IEC/EN 60950-1 ATTACHMENT 1			
Clause	Requirement + Test	Result - Remark	Verdict
<b>ZB ANNEX (normative)</b> <b>SPECIAL NATIONAL CONDITIONS (EN)</b>			
Clause	Requirement + Test	Result - Remark	Verdict
1.7.2.1 (A11:2009)	<p>In <b>Norway</b> and <b>Sweden</b>, the screen of the cable distribution system is normally not earthed at the entrance of the building and there is normally no equipotential bonding system within the building. Therefore the protective earthing of the building installation need to be isolated from the screen of a cable distribution system.</p> <p>It is however accepted to provide the insulation external to the equipment by an adapter or an interconnection cable with galvanic isolator, which may be provided by e.g. a retailer.</p> <p>The user manual shall then have the following or similar information in Norwegian and Swedish language respectively, depending on in what country the equipment is intended to be used in:</p> <p>“Equipment connected to the protective earthing of the building installation through the mains connection or through other equipment with a connection to protective earthing – and to a cable distribution system using coaxial cable, may in some circumstances create a fire hazard. Connection to a cable distribution system has therefore to be provided through a device providing electrical isolation below a certain frequency range (galvanic isolator, see EN 60728-11).”</p> <p>NOTE In Norway, due to regulation for installations of cable distribution systems, and in Sweden, a galvanic isolator shall provide electrical insulation below 5 MHz. The insulation shall withstand a dielectric strength of 1,5 kV r.m.s., 50 Hz or 60 Hz, for 1 min.</p> <p>Translation to Norwegian (the Swedish text will also be accepted in Norway):</p> <p>“Utstyr som er koplet til beskyttelsesjord via nettplugg og/eller via annet jordtilkoplet utstyr – og er tilkoplet et kabel-TV nett, kan forårsake brannfare. For å unngå dette skal det ved tilkopling av utstyret til kabel-TV nettet installeres en galvanisk isolator mellom utstyret og kabel-TV nettet.”</p> <p>Translation to Swedish:</p> <p>”Utrustning som är kopplad till skyddsjord via jordat vägguttag och/eller via annan utrustning och samtidigt är kopplad till kabel-TV nät kan i vissa fall medföra risk för brand. För att undvika detta skall vid anslutning av utrustningen till kabel-TV nät galvanisk isolator finnas mellan utrustningen och kabel-TV nätet.”</p>	Class III equipment	N/A

This report shall not be reproduced except in full, without the written approval of KES Co., Ltd.  
The results shown in this test report refer only to the sample(s) tested unless otherwise stated.  
The authenticity of the test report, contact shchoi@kes.co.kr



<b>IEC/EN 60950-1 ATTACHMENT 1</b>			
Clause	Requirement + Test	Result - Remark	Verdict
<b>ZB ANNEX (normative) SPECIAL NATIONAL CONDITIONS (EN)</b>			
Clause	Requirement + Test	Result - Remark	Verdict
1.7.2.1 (A2:2013)	In <b>Denmark</b> , CLASS I PLUGGABLE EQUIPMENT TYPE A intended for connection to other equipment or a network shall, if safety relies on connection to protective earth or if surge suppressors are connected between the network terminals and accessible parts, have a marking stating that the equipment must be connected to an earthed mains socket-outlet.  The marking text in <b>Denmark</b> shall be as follows: In <b>Denmark</b> : "Apparatets stikprop skal tilsluttes en stikkontakt med jord, som giver forbindelse til stikpropens jord."	Class III equipment	N/A
1.7.5  1.7.5 (A11:2009)	In <b>Denmark</b> , socket-outlets for providing power to other equipment shall be in accordance with the Heavy Current Regulations, Section 107-2-D1, Standard Sheet DK 1-3a, DK 1-5a or DK 1-7a, when used on Class I equipment. For STATIONARY EQUIPMENT the socket-outlet shall be in accordance with Standard Sheet DK 1-1b or DK 1-5a.  For <b>CLASS II EQUIPMENT</b> the socket outlet shall be in accordance with Standard Sheet DKA 1-4a.	No socket-outlets for providing power to other equipment	N/A
1.7.5 (A2:2013)	In <b>Denmark</b> , socket-outlets for providing power to other equipment shall be in accordance with the DS 60884-2-D1:2011.  For class I equipment the following Standard Sheets are applicable: DK 1-3a, DK 1-1c, DK 1-1d, DK 1-5a or DK 1-7a, with the exception for STATIONARY EQUIPMENT where the socket-outlets shall be in accordance with Standard Sheet DK 1-1b, DK 1-1c, DK 1-1d or DK 1-5a.  Socket outlets intended for providing power to Class II apparatus with a rated current of 2,5 A shall be in accordance with DS 60884-2-D1 standard sheet DKA 1-4a. Other current rating socket outlets shall be in compliance with by DS 60884-2-D1 Standard Sheet DKA 1-3a or DKA 1-3b.  Justification the Heavy Current Regulations, 6c	No socket-outlets for providing power to other equipment	N/A
2.2.4	In <b>Norway</b> , for requirements see 1.7.2.1, 6.1.2.1 and 6.1.2.2 of this annex.	No TNV circuits	N/A
2.3.2	In <b>Finland, Norway and Sweden</b> there are additional requirements for the insulation. See 6.1.2.1 and 6.1.2.2 of this annex.	No TNV circuits	N/A
2.3.4	In <b>Norway</b> , for requirements see 1.7.2.1, 6.1.2.1 and 6.1.2.2 of this annex.	No TNV circuits	N/A

This report shall not be reproduced except in full, without the written approval of KES Co., Ltd.  
 The results shown in this test report refer only to the sample(s) tested unless otherwise stated.  
 The authenticity of the test report, contact shchoi@kes.co.kr



<b>IEC/EN 60950-1 ATTACHMENT 1</b>			
Clause	Requirement + Test	Result - Remark	Verdict

<b>ZB ANNEX (normative) SPECIAL NATIONAL CONDITIONS (EN)</b>			
Clause	Requirement + Test	Result - Remark	Verdict
2.6.3.3	In the <b>United Kingdom</b> , the current rating of the circuit shall be taken as 13 A, not 16 A.	Class III equipment	N/A
2.7.1	In the <b>United Kingdom</b> , to protect against excessive currents and short-circuits in the PRIMARY CIRCUIT of DIRECT PLUG-IN EQUIPMENT, tests according to 5.3 shall be conducted, using an external protective device rated 30 A or 32 A. If these tests fail, suitable protective devices shall be included as integral parts of the DIRECT PLUG-IN EQUIPMENT, so that the requirements of 5.3 are met.	Class III equipment	N/A
2.10.5.13	In <b>Finland, Norway and Sweden</b> , there are additional requirements for the insulation, see 6.1.2.1 and 6.1.2.2 of this annex.	No TNV circuits	N/A
3.2.1.1	<p>In <b>Switzerland</b>, supply cords of equipment having a RATED CURRENT not exceeding 10 A shall be provided with a plug complying with SEV 1011 or IEC 60884-1 and one of the following dimension sheets:</p> <p>SEV 6532-2.1991 Plug Type 15 3P+N+PE 250/400 V, 10 A</p> <p>SEV 6533-2.1991 Plug Type 11 L+N 250 V, 10 A</p> <p>SEV 6534-2.1991 Plug Type 12 L+N+PE 250 V, 10 A</p> <p>In general, EN 60309 applies for plugs for currents exceeding 10 A. However, a 16 A plug and socket-outlet system is being introduced in Switzerland, the plugs of which are according to the following dimension sheets, published in February 1998:</p> <p>SEV 5932-2.1998: Plug Type 25 , 3L+N+PE 230/400 V, 16 A</p> <p>SEV 5933-2.1998: Plug Type 21, L+N, 250 V, 16A</p> <p>SEV 5934-2.1998: Plug Type 23, L+N+PE 250 V, 16 A</p>	Class III equipment	N/A

This report shall not be reproduced except in full, without the written approval of KES Co., Ltd.  
 The results shown in this test report refer only to the sample(s) tested unless otherwise stated.  
 The authenticity of the test report, contact shchoi@kes.co.kr



IEC/EN 60950-1 ATTACHMENT 1			
Clause	Requirement + Test	Result - Remark	Verdict
<b>ZB ANNEX (normative) SPECIAL NATIONAL CONDITIONS (EN)</b>			
Clause	Requirement + Test	Result - Remark	Verdict
3.2.1.1	<p>In <b>Denmark</b>, supply cords of single-phase equipment having a rated current not exceeding 13 A shall be provided with a plug according to the Heavy Current Regulations, Section 107-2-D1.</p> <p>CLASS I EQUIPMENT provided with socket-outlets with earth contacts or which are intended to be used in locations where protection against indirect contact is required according to the wiring rules shall be provided with a plug in accordance with standard sheet DK 2-1a or DK 2-5a.</p> <p>If poly-phase equipment and single-phase equipment having a RATED CURRENT exceeding 13 A is provided with a supply cord with a plug, this plug shall be in accordance with the Heavy Current Regulations, Section 107-2-D1 or EN 60309-2.</p>	Class III equipment	N/A
3.2.1.1 (A2:2013)	<p>In <b>Denmark</b>, supply cords of single-phase equipment having a rated current not exceeding 13 A shall be provided with a plug according to DS 60884-2-D1.</p> <p>CLASS I EQUIPMENT provided with socket-outlets with earth contacts or which are intended to be used in locations where protection against indirect contact is required according to the wiring rules shall be provided with a plug in accordance with standard sheet DK 2-1a or DK 2-5a.</p> <p>If a single-phase equipment having a RATED CURRENT exceeding 13 A or if a poly-phase equipment is provided with a supply cord with a plug, this plug shall be in accordance with the standard sheets DK 6-1a in DS 60884-2-D1 or EN 60309-2.</p> <p>Justification the Heavy Current Regulations, 6c</p>	Class III equipment	N/A

This report shall not be reproduced except in full, without the written approval of KES Co., Ltd.  
The results shown in this test report refer only to the sample(s) tested unless otherwise stated.  
The authenticity of the test report, contact shchoi@kes.co.kr



<b>IEC/EN 60950-1 ATTACHMENT 1</b>			
Clause	Requirement + Test	Result - Remark	Verdict
<b>ZB ANNEX (normative) SPECIAL NATIONAL CONDITIONS (EN)</b>			
Clause	Requirement + Test	Result - Remark	Verdict
3.2.1.1	<p>In <b>Spain</b>, supply cords of single-phase equipment having a rated current not exceeding 10 A shall be provided with a plug according to UNE 20315:1994.</p> <p>Supply cords of single-phase equipment having a rated current not exceeding 2,5 A shall be provided with a plug according to UNE-EN 50075:1993.</p> <p>CLASS I EQUIPMENT provided with socket-outlets with earth contacts or which are intended to be used in locations where protection against indirect contact is required according to the wiring rules, shall be provided with a plug in accordance with standard UNE 20315:1994.</p> <p>If poly-phase equipment is provided with a supply cord with a plug, this plug shall be in accordance with UNE-EN 60309-2.</p>	Class III equipment	N/A
3.2.1.1	<p>In the <b>United Kingdom</b>, apparatus which is fitted with a flexible cable or cord and is designed to be connected to a mains socket conforming to BS 1363 by means of that flexible cable or cord and plug, shall be fitted with a 'standard plug' in accordance with Statutory Instrument 1768:1994 - The Plugs and Sockets etc. (Safety) Regulations 1994, unless exempted by those regulations.</p> <p>NOTE 'Standard plug' is defined in SI 1768:1994 and essentially means an approved plug conforming to BS 1363 or an approved conversion plug.</p>	Class III equipment	N/A
3.2.1.1	<p>In <b>Ireland</b>, apparatus which is fitted with a flexible cable or cord and is designed to be connected to a mains socket conforming to I.S. 411 by means of that flexible cable or cord and plug, shall be fitted with a 13 A plug in accordance with Statutory Instrument 525:1997 - National Standards Authority of Ireland (section 28) (13 A Plugs and Conversion Adaptors for Domestic Use) Regulations 1997.</p>	Class III equipment	N/A
3.2.4	<p>In <b>Switzerland</b>, for requirements see 3.2.1.1 of this annex.</p>	Class III equipment	N/A
3.2.5.1	<p>In the <b>United Kingdom</b>, a power supply cord with conductor of 1,25 mm<sup>2</sup> is allowed for equipment with a rated current over 10 A and up to and including 13 A.</p>	Class III equipment	N/A
3.3.4	<p>In the <b>United Kingdom</b>, the range of conductor sizes of flexible cords to be accepted by terminals for equipment with a RATED CURRENT of over 10 A up to and including 13 A is:</p> <ul style="list-style-type: none"> <li>• 1,25 mm<sup>2</sup> to 1,5 mm<sup>2</sup> nominal cross-sectional area.</li> </ul>	Class III equipment	N/A

This report shall not be reproduced except in full, without the written approval of KES Co., Ltd.  
 The results shown in this test report refer only to the sample(s) tested unless otherwise stated.  
 The authenticity of the test report, contact shchoi@kes.co.kr





IEC/EN 60950-1 ATTACHMENT 1			
Clause	Requirement + Test	Result - Remark	Verdict
<b>ZB ANNEX (normative) SPECIAL NATIONAL CONDITIONS (EN)</b>			
Clause	Requirement + Test	Result - Remark	Verdict
4.3.6	In the <b>United Kingdom</b> , the torque test is performed using a socket outlet complying with BS 1363 part 1:1995, including Amendment 1:1997 and Amendment 2:2003 and the plug part of DIRECT PLUG-IN EQUIPMENT shall be assessed to BS 1363: Part 1, 12.1, 12.2, 12.3, 12.9, 12.11, 12.12, 12.13, 12.16 and 12.17, except that the test of 12.17 is performed at not less than 125 °C. Where the metal earth pin is replaced by an Insulated Shutter Opening Device (ISOD), the requirements of clauses 22.2 and 23 also apply.		N/A
4.3.6	In <b>Ireland</b> , DIRECT PLUG-IN EQUIPMENT is known as plug similar devices. Such devices shall comply with Statutory Instrument 526:1997 - National Standards Authority of Ireland (Section 28) (Electrical plugs, plug similar devices and sockets for domestic use) Regulations, 1997.		N/A
5.1.7.1	In <b>Finland, Norway and Sweden</b> TOUCH CURRENT measurement results exceeding 3,5 mA r.m.s. are permitted only for the following equipment: • STATIONARY PLUGGABLE EQUIPMENT TYPE A that is intended to be used in a RESTRICTED ACCESS LOCATION where equipotential bonding has been applied, for example, in a telecommunication centre; and has provision for a permanently connected PROTECTIVE EARTHING CONDUCTOR; and is provided with instructions for the installation of that conductor by a SERVICE PERSON; • STATIONARY PLUGGABLE EQUIPMENT TYPE B; • STATIONARY PERMANENTLY CONNECTED EQUIPMENT.		N/A

This report shall not be reproduced except in full, without the written approval of KES Co., Ltd.  
The results shown in this test report refer only to the sample(s) tested unless otherwise stated.  
The authenticity of the test report, contact shchoi@kes.co.kr



<b>IEC/EN 60950-1 ATTACHMENT 1</b>			
Clause	Requirement + Test	Result - Remark	Verdict

<b>ZB ANNEX (normative) SPECIAL NATIONAL CONDITIONS (EN)</b>			
Clause	Requirement + Test	Result - Remark	Verdict
6.1.2.1 (A1:2010)	<p><b>In Finland, Norway and Sweden</b>, add the following text between the first and second paragraph of the compliance clause:</p> <p>If this insulation is solid, including insulation forming part of a component, it shall at least consist of either</p> <ul style="list-style-type: none"> <li>-two layers of thin sheet material, each of which shall pass the electric strength test below, or</li> <li>-one layer having a distance through insulation of at least 0,4 mm, which shall pass the electric strength test below.</li> </ul> <p>Alternatively for components, there is no distance through insulation requirements for the insulation consisting of an insulating compound completely filling the casing, so that CLEARANCES and CREEPAGE DISTANCES do not exist, if the component passes the electric strength test in accordance with the compliance clause below and in addition</p> <ul style="list-style-type: none"> <li>- passes the tests and inspection criteria of 2.10.11 with an electric strength test of 1,5 kV multiplied by 1,6 (the electric strength test of 2.10.10 shall be performed using 1,5 kV), and</li> <li>- is subject to ROUTINE TESTING for electric strength during manufacturing, using a test voltage of 1,5 kV.</li> </ul> <p>It is permitted to bridge this insulation with an optocoupler complying with 2.10.5.4 b).</p> <p>It is permitted to bridge this insulation with a capacitor complying with EN 60384-14:2005, subclass Y2.</p> <p>A capacitor classified Y3 according to EN 60384-14:2005, may bridge this insulation under the following conditions:</p> <ul style="list-style-type: none"> <li>- the insulation requirements are satisfied by having a capacitor classified Y3 as defined by EN 60384-14, which in addition to the Y3 testing, is tested with an impulse test of 2,5 kV defined in EN 60950-1:2006, 6.2.2.1;</li> <li>- the additional testing shall be performed on all the test specimens as described in EN 60384-14:</li> <li>- the impulse test of 2,5 kV is to be performed before the endurance test in EN 60384-14, in the sequence of tests as described in EN 60384-14.</li> </ul>	No TNV circuits	N/A

This report shall not be reproduced except in full, without the written approval of KES Co., Ltd.  
 The results shown in this test report refer only to the sample(s) tested unless otherwise stated.  
 The authenticity of the test report, contact shchoi@kes.co.kr



<b>IEC/EN 60950-1 ATTACHMENT 1</b>			
Clause	Requirement + Test	Result - Remark	Verdict
<b>ZB ANNEX (normative) SPECIAL NATIONAL CONDITIONS (EN)</b>			
Clause	Requirement + Test	Result - Remark	Verdict
6.1.2.2	In <b>Finland, Norway and Sweden</b> , the exclusions are applicable for PERMANENTLY CONNECTED EQUIPMENT, PLUGGABLE EQUIPMENT TYPE B and equipment intended to be used in a RESTRICTED ACCESS LOCATION where equipotential bonding has been applied, e.g. in a telecommunication centre, and which has provision for a permanently connected PROTECTIVE EARTHING CONDUCTOR and is provided with instructions for the installation of that conductor by a SERVICE PERSON.	Not for connection to cable distribution systems.	N/A
7.2	In <b>Finland, Norway and Sweden</b> , for requirements see 6.1.2.1 and 6.1.2.2 of this annex. The term TELECOMMUNICATION NETWORK in 6.1.2 being replaced by the term CABLE DISTRIBUTION SYSTEM.		N/A
7.3 (A11:2009)	In <b>Norway and Sweden</b> , for requirements see 1.2.13.14 and 1.7.2.1 of this annex.		N/A

This report shall not be reproduced except in full, without the written approval of KES Co., Ltd.  
The results shown in this test report refer only to the sample(s) tested unless otherwise stated.  
The authenticity of the test report, contact shchoi@kes.co.kr



**IEC/EN 60950-1 ATTACHMENT 1**

Clause	Requirement + Test	Result - Remark	Verdict
--------	--------------------	-----------------	---------

**Annex ZD  
(informative)**

**IEC and CENELEC code designations for flexible cords**

Type of flexible cord	Code designations	
	IEC	CENELEC
<b>PVC insulated cords</b>		
Flat twin tinsel cord	60227 IEC 41	H03VH-Y
Light polyvinyl chloride sheathed flexible cord	60227 IEC 52	H03VV-F H03VVH2-F
Ordinary polyvinyl chloride sheathed flexible cord	60277 IEC 53	H05VV-F H05VVH2-F
<b>Rubber insulated cords</b>		
Braided cord	60245 IEC 51	H03RT-F
Ordinary tough rubber sheathed flexible cord	60245 IEC 53	H05RR-F
Ordinary polychloroprene sheathed flexible cord	60245 IEC 57	H05RN-F
Heavy polychloroprene sheathed flexible cord	60245 IEC 66	H07RN-F
<b>Cords having high flexibility</b>		
Rubber insulated and sheathed cord	60245 IEC 86	H03RR-H
Rubber insulated, crosslinked PVC sheathed cord	60245 IEC 87	H03RV4-H
Crosslinked PVC insulated and sheathed cord	60245 IEC 88	H03V4V4-H

This report shall not be reproduced except in full, without the written approval of KES Co., Ltd.  
The results shown in this test report refer only to the sample(s) tested unless otherwise stated.  
The authenticity of the test report, contact shchoi@kes.co.kr

**IEC/EN 60950-1 ATTACHMENT 2**

**PHOTOS**



< Exterior bottom/front/side view >



< Exterior top/rear/side view >

This report shall not be reproduced except in full, without the written approval of KES Co., Ltd.  
The results shown in this test report refer only to the sample(s) tested unless otherwise stated.  
The authenticity of the test report, contact [shchoi@kes.co.kr](mailto:shchoi@kes.co.kr)

**IEC/EN 60950-1 ATTACHMENT 2**  
**PHOTOS**



< Exterior front view >



< Exterior rear view >

This report shall not be reproduced except in full, without the written approval of KES Co., Ltd.  
The results shown in this test report refer only to the sample(s) tested unless otherwise stated.  
The authenticity of the test report, contact shchoi@kes.co.kr

**IEC/EN 60950-1 ATTACHMENT 2**

**PHOTOS**



< Internal top view >



< Exterior view of HDD slot >

This report shall not be reproduced except in full, without the written approval of KES Co., Ltd.  
The results shown in this test report refer only to the sample(s) tested unless otherwise stated.  
The authenticity of the test report, contact [shchoi@kes.co.kr](mailto:shchoi@kes.co.kr)

**IEC/EN 60950-1 ATTACHMENT 2**

**PHOTOS**



< Exterior view of HDD slot >



< Internal view of HDD slot >

This report shall not be reproduced except in full, without the written approval of KES Co., Ltd.  
The results shown in this test report refer only to the sample(s) tested unless otherwise stated.  
The authenticity of the test report, contact [shchoi@kes.co.kr](mailto:shchoi@kes.co.kr)



<b>IEC/EN 60950-1 ATTACHMENT 2</b>
<b>PHOTOS</b>



< DC fan view in HDD slot >



< Main PCB top view >

This report shall not be reproduced except in full, without the written approval of KES Co., Ltd.  
The results shown in this test report refer only to the sample(s) tested unless otherwise stated.  
The authenticity of the test report, contact [shchoi@kes.co.kr](mailto:shchoi@kes.co.kr)

**IEC/EN 60950-1 ATTACHMENT 2**

**PHOTOS**

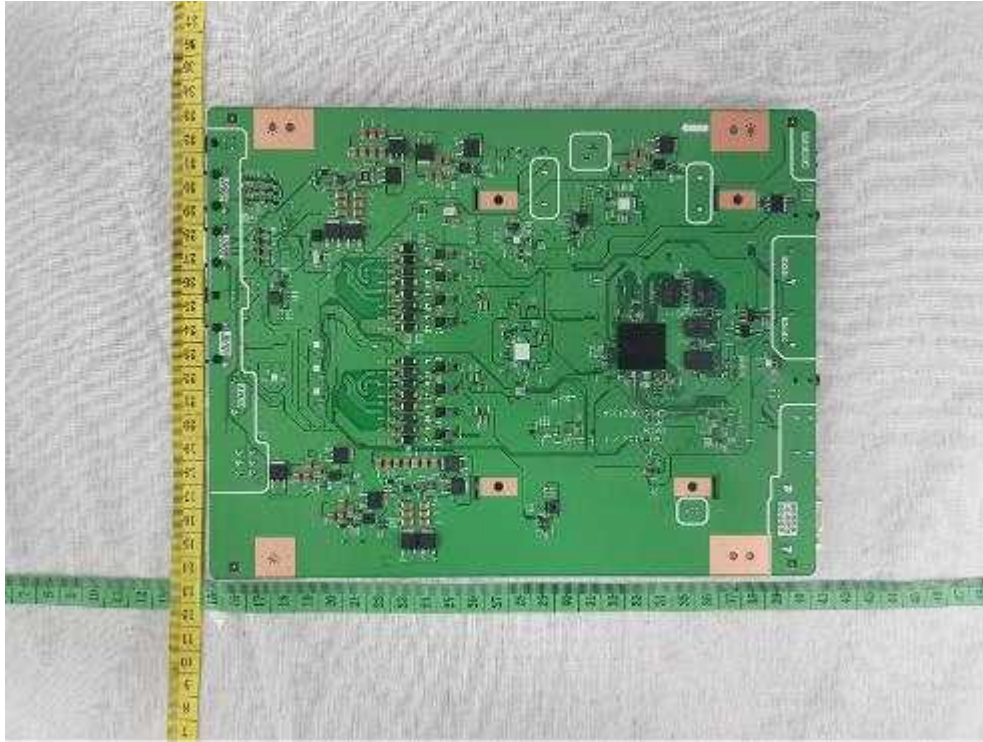

< Main PCB bottom view >

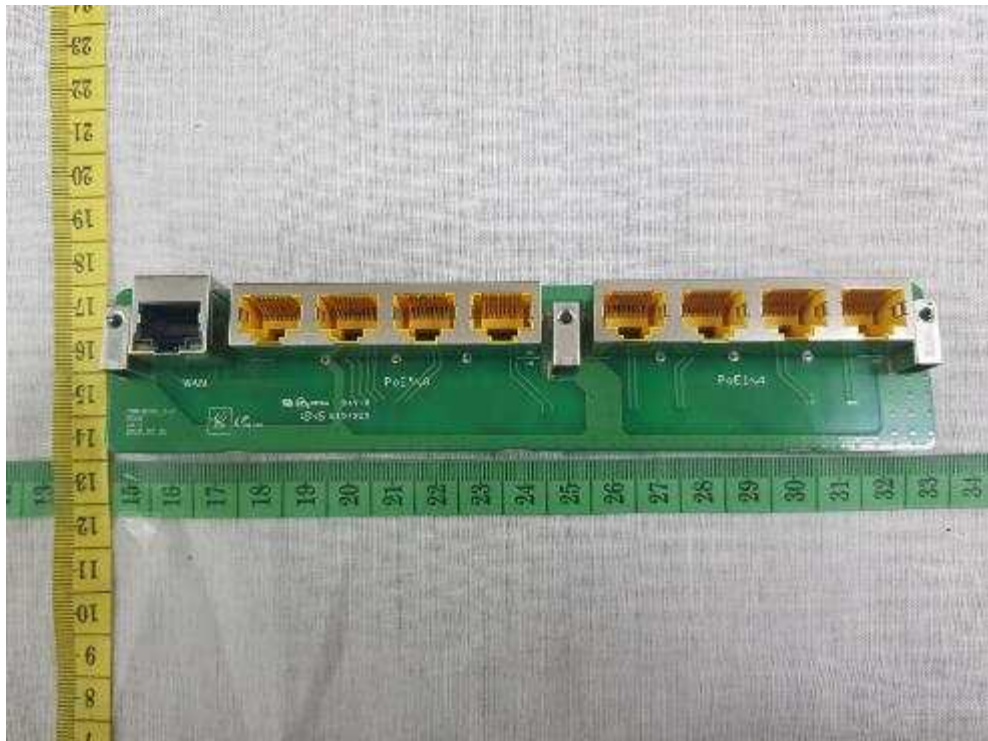

< PoE PCB top view >

This report shall not be reproduced except in full, without the written approval of KES Co., Ltd.  
The results shown in this test report refer only to the sample(s) tested unless otherwise stated.  
The authenticity of the test report, contact [shchoi@kes.co.kr](mailto:shchoi@kes.co.kr)

**IEC/EN 60950-1 ATTACHMENT 2**

**PHOTOS**

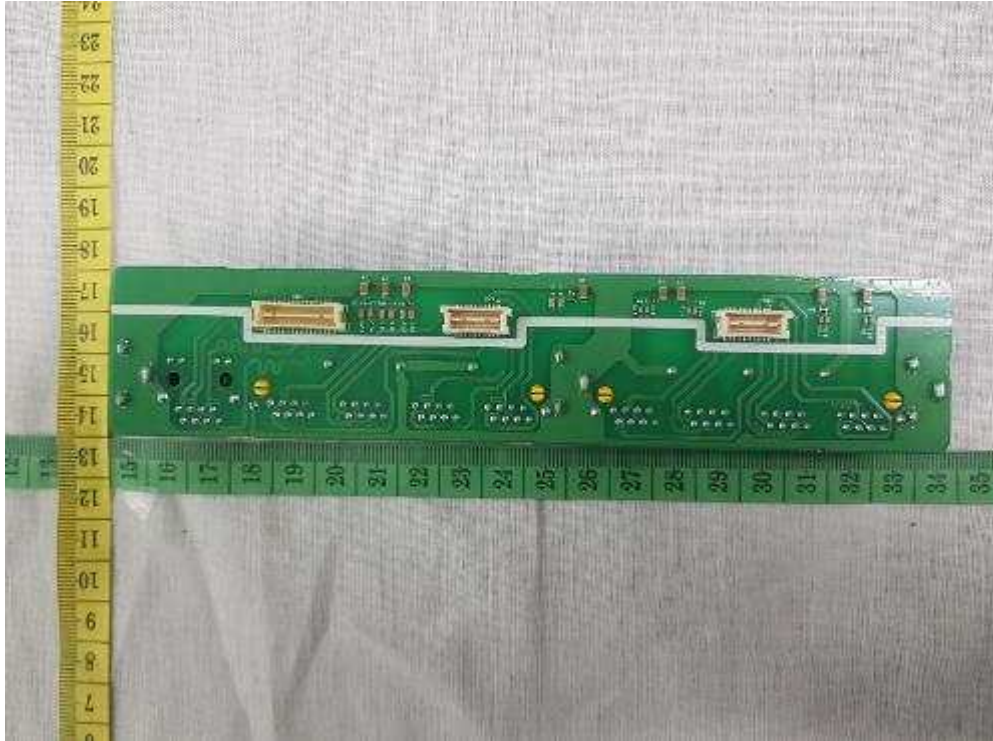

< PoE PCB bottom view >

- The end of test report -

This report shall not be reproduced except in full, without the written approval of KES Co., Ltd.  
The results shown in this test report refer only to the sample(s) tested unless otherwise stated.  
The authenticity of the test report, contact [shchoi@kes.co.kr](mailto:shchoi@kes.co.kr)