

WISENET

NETWORK SWITCH

Quick Manual

SPN-10080P
SPN-10080PM

CE

Network Switch

Quick Manual

Copyright

©2017 Hanwha Techwin Co., Ltd. All rights reserved.

Trademark

Each of trademarks herein is registered. The name of this product and other trademarks mentioned in this manual are the registered trademark of their respective company.

Restriction

Copyright of this document is reserved. Under no circumstances, this document shall be reproduced, distributed or changed, partially or wholly, without formal authorization.

Disclaimer

Hanwha Techwin makes the best to verify the integrity and correctness of the contents in this document, but no formal guarantee shall be provided. Use of this document and the subsequent results shall be entirely on the user's own responsibility. Hanwha Techwin reserves the right to change the contents of this document without prior notice.

❖ Design and specifications are subject to change without prior notice.

IMPORTANT SAFETY INSTRUCTIONS

Read these operating instructions carefully before using the unit.
Follow all the safety instructions listed below.
Keep these operating instructions handy for future reference.

- 1) Read these instructions.
- 2) Keep these instructions.
- 3) Heed all warnings.
- 4) Follow all instructions.
- 5) Do not use this apparatus near water.
- 6) Clean the contaminated area on the product surface with a soft, dry cloth or a damp cloth. (Do not use a detergent or cosmetic products that contain alcohol, solvents or surfactants or oil constituents as they may deform or cause damage to the product.)
- 7) Do not block any ventilation openings, Install in accordance with the manufacturer's instructions.
- 8) Do not install near any heat sources such as radiators, heat registers, stoves, or other apparatus (including amplifiers) that produce heat.
- 9) Do not defeat the safety purpose of the polarized or grounding- type plug. A polarized plug has two blades with one wider than the other. A grounding type plug has two blades and a third grounding prong. The wide blade or the third prong are provided for your safety. If the provided plug does not fit into your outlet, consult an electrician for replacement of the obsolete outlet.
- 10) Protect the power cord from being walked on or pinched particularly at plugs, convenience receptacles, and the point where they exit from the apparatus.
- 11) Only use attachments/accessories specified by the manufacturer.
- 12) Use only with the cart, stand, tripod, bracket, or table specified by the manufacturer, or sold with the apparatus. When a cart is used, use caution when moving the cart/ apparatus combination to avoid injury from tip-over.
- 13) Unplug this apparatus during lightning storms or when unused for long periods of time.
- 14) Refer all servicing to qualified service personnel. Servicing is required when the apparatus has been damaged in any way, such as power-supply cord or plug is damaged, liquid has been spilled or objects have fallen into the apparatus, the apparatus has been exposed to rain or moisture, does not operate normally, or has been dropped.



Standards Approvals



- ! Any changes or modifications in construction of this device which are not expressly approved by the party responsible for compliance could void the user's authority to operate the equipment.
- ✍ This device complies with part 15 of the FCC Rules. Operation is subject to the following two conditions: (1) This device may not cause harmful interference, and (2) this device must accept any interference received, including interference that may cause undesired operation.
 - This equipment has been tested and found to comply with the limits for a Class A digital device, pursuant to part 15 of the FCC Rules. These limits are designed to provide reasonable protection against harmful interference when the equipment is operated in a commercial environment. This equipment generates, uses, and can radiate radio frequency energy and, if not installed and used in accordance with the instruction manual, may cause harmful interference to radio communications. Operation of this equipment in a residential area is likely to cause harmful interference in which case the user will be required to correct the interference at his own expense.

BEFORE START

This manual provides operational information necessary for using the product and contains a description about each component part and its function as well as menu or network settings.

You have to keep in mind the following notices :



- Hanwha Techwin retains the copyright on this manual.
- This manual cannot be copied without Hanwha Techwin's prior written approval.
- We are not liable for any or all losses to the product incurred by your use of non-standard product or violation of instructions mentioned in this manual.
- Prior to opening the case, please consult a qualified technician first. Whenever this is needed power must be removed from the unit.
- Before adding a hard disk drive or external storage (USB memory, USB HDD, etc), check if it is compliant with this product. For the compatibility list, contact the retailer.

PRECAUTIONS RELATED TO INSTALLATION AND USE

- Users should not disassemble the switch arbitrarily.
- Users should be careful when handling the switch.
- Users should not punch or shake the switch. The user should take care not to cause damage due to careless storage or incorrect operation.
- The switch should not be installed in places where it rains or where there is high humidity. It should not be operated in wet environments.
- The switch body should not be cleaned using a harsh abrasive. When it gets dirty, it should be cleaned with a dry cloth.
- The switch should be installed in a cool place, away from direct sunlight.
- Direct sunlight may negatively affect the product.
- Ensure that there is adequate ventilation around the switch when installing the switch on a shelf or rack.
- Be sure to visually check the power cord (power cable) for any abnormality before connecting to the power supply.
- Allow sufficient space around the product for heat dissipation.
- Do not place heavy objects on the product.

Package Contents

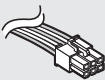
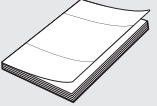
Make sure you have all of the following.
(Accessories may vary depending on the country of sale.)

		
Switch body	Power cable	Quick Manual
		
Fixing screws		



Hanwha Techwin cares for the environment at all product manufacturing stages, and is taking measures to provide customers with more environmentally friendly products.
The Eco mark represents Hanwha Techwin's devotion to creating environmentally friendly products, and indicates that the product satisfies the EU RoHS Directive.



Correct Disposal of This Product (Waste Electrical & Electronic Equipment)

(Applicable in the European Union and other European countries with separate collection systems)

This marking on the product, accessories or literature indicates that the product and its electronic accessories (e.g. charger, headset, USB cable) should not be disposed of with other household waste at the end of their working life. To prevent possible harm to the environment or human health from uncontrolled waste disposal, please separate these items from other types of waste and recycle them responsibly to promote the sustainable reuse of material resources.

Household users should contact either the retailer where they purchased this product, or their local government office, for details of where and how they can take these items for environmentally safe recycling.

Business users should contact their supplier and check the terms and conditions of the purchase contract. This product and its electronic accessories should not be mixed with other commercial wastes for disposal.



Correct disposal of batteries in this product

(Applicable in the European Union and other European countries with separate battery return systems.)

This marking on the battery, manual or packaging indicates that the batteries in this product should not be disposed of with other household waste at the end of their working life. Where marked, the chemical symbols Hg, Cd or Pb indicate that the battery contains mercury, cadmium or lead above the reference levels in EC Directive 2006/66. If batteries are not properly disposed of, these substances can cause harm to human health or the environment.

To protect natural resources and to promote material reuse, please separate batteries from other types of waste and recycle them through your local, free battery return system.

PART NAMES AND FUNCTIONS

Front

- SPN-10080P

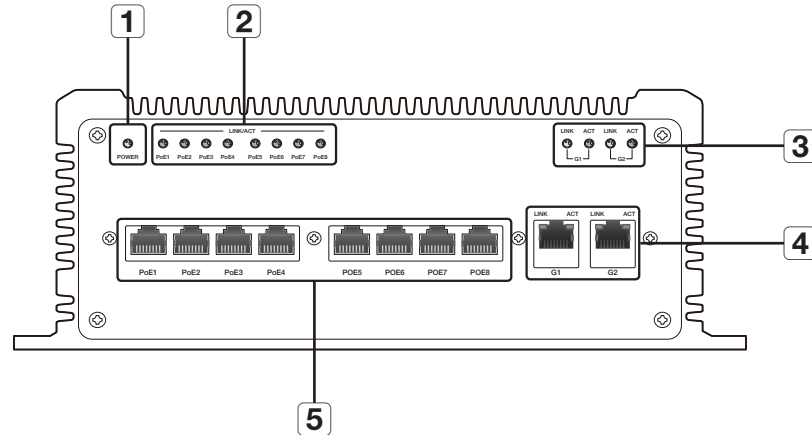

- SPN-10080PM

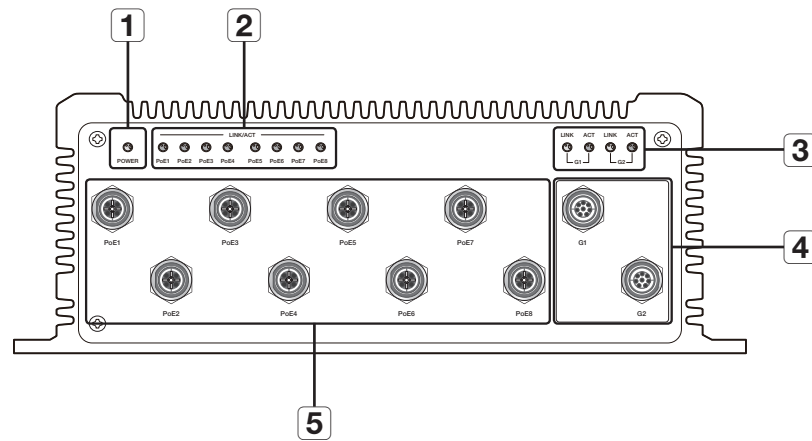

Rear

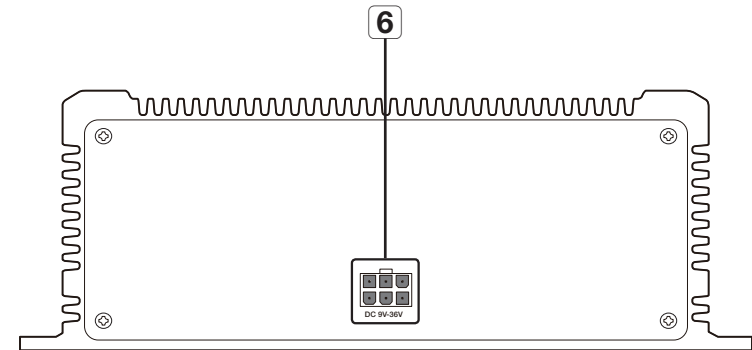

Part Names		Functions
1	POWER	Shows the power On/Off status.
2	LED lamp	PoE1~8 When the PoE camera is connected, the LED will blink.
3	Giga port	Displays the LINK/ACT connection status.
4	G1, G2	The main set or switch is connected to a Gigabit Ethernet port.
5	PoE1~8	PoE camera connection terminal.
6	Power input (DC 9 - 36V)	Terminal to connect to the power supply. Use the power cable provided when purchasing the product.

- ! The maximum power of PoE 1 to 4 and PoE 5 to 8 is 32W.
- Please connect/install the camera in a manner that ensures that 32W is not exceeded.
- When 32W is exceeded, the power of the last connected PoE is turned off.
- If 32W is exceeded during operation, PoE power is turned off in order of PoE 4 to 1 and PoE 8 to 5.
- If the power consumption of cameras connected to the set (eg., PoE1 - PoE4) is less than 24W, PoE cameras can be connected to the powered-off port.

How to install and connect

DC POWER CONNECTOR WIRING DIAGRAM

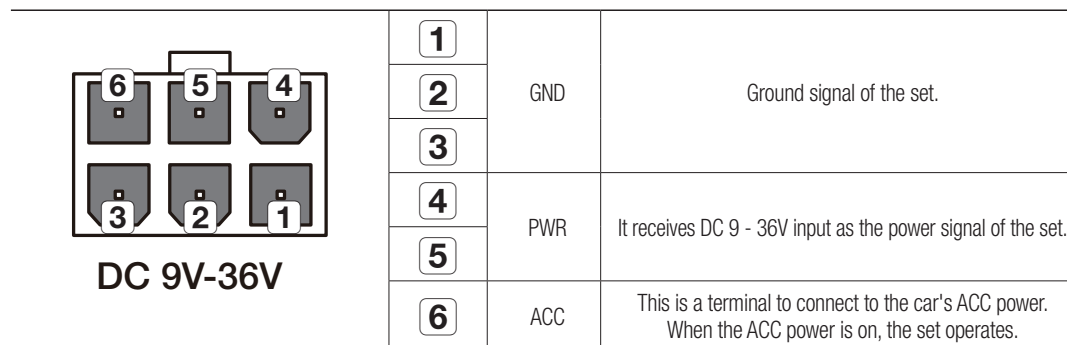

! If the ACC yellow line on the power cable is not connected to the power or the car's ACC terminal, the power will not turn on.

HOW TO CHECK M12 TERMINAL PINS

Gigabit Ethernet (M12 8pin A-Code Pinout)

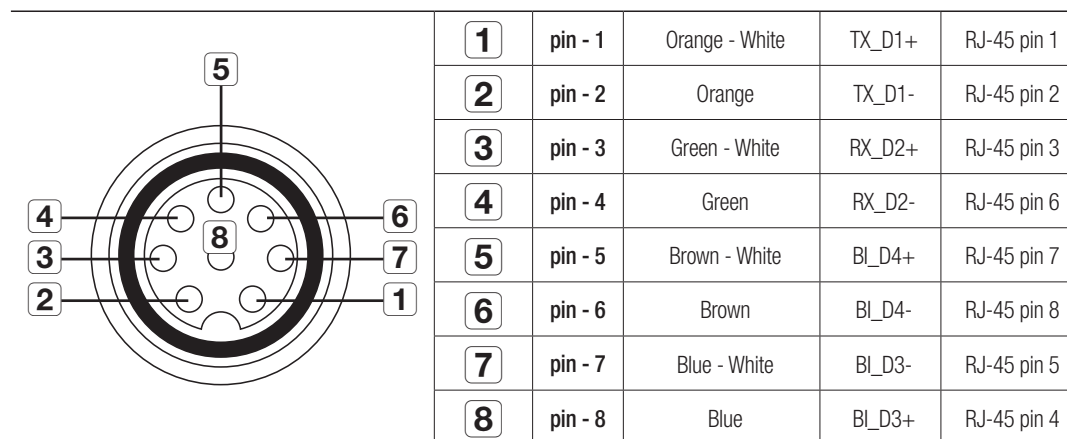

PoE (M12 4pin D-Code Pinout)

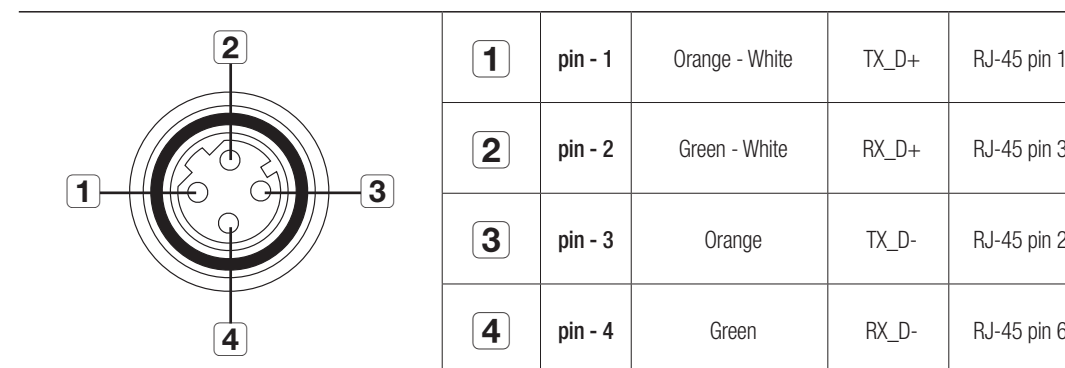

HOW TO CONNECT TO SWITCH

Connect the Ethernet port of the switch to the Ethernet port of the PC with a LAN cable (RJ-45).

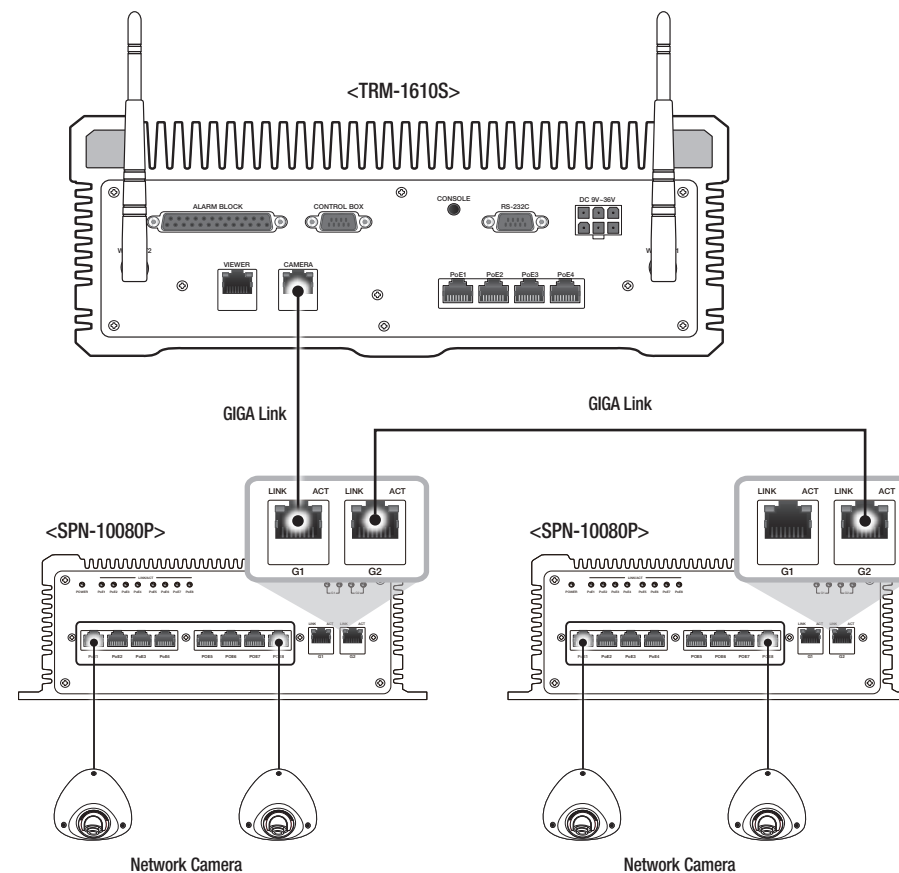

PRODUCT SPECIFICATION

Item	Details	
	SPN-10080PM	SPN-10080P
PoE		
Maximum PoE Budget	64W(32W + 32W)	
PoE Standard	IEEE 802.3af / 802.3at	
PoE/PoE+ Ports	Port 1 ~ 8 : PoE/PoE+	
Performance		
Switching Capacity	2.8Gbps	
Compatible Devices		
Network CCTV Devices	WiseNet Network Cameras, TRM NVR Series	
Interface		
1000Base-T Interface	2 (M12, A-Code, 8P Female)	2 RJ-45
100Base-T PoE Interface	8 (M12, D-Code, 4P Female)	8 RJ-45
MDI/MDIX adjustable	Yes	
Power Input	Molex 6P -> 6P Gender Included	
Indicator		
LED	Power Status : 1 EA G 1 : Link 1 EA, ACT1 EA G 2 : Link 1 EA, ACT1 EA PoE(1~8) Link: 8 EA	

Item	Details	
	SPN-10080PM	SPN-10080P
General		
Dimension (W x D x H)	270 x 134 x 93mm	
Weight	2.68 Kg	2.6 Kg
Operation Temperature	-40 ~ 75°C	
Operation/Storage Humidity	0% - 95% RH	
Maximum Power Consumption	95W	
Power Input	9 ~ 36 VDC (Fanless)	
Color/Material	Black / Al	
Standard Approval		
General	CE, FCC, cUL	
Special	EN-50155 (Rail Shock/Vib) EN-50121-4 (Railway EMC)	

PRODUCT OVERVIEW

- SPN-10080P

unit : mm (inches)

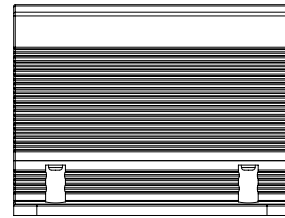
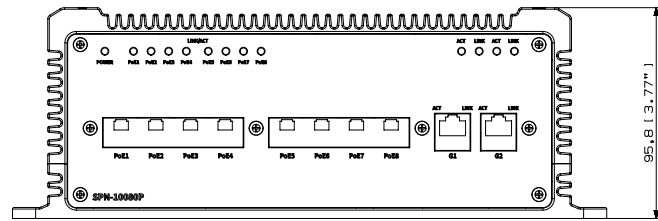
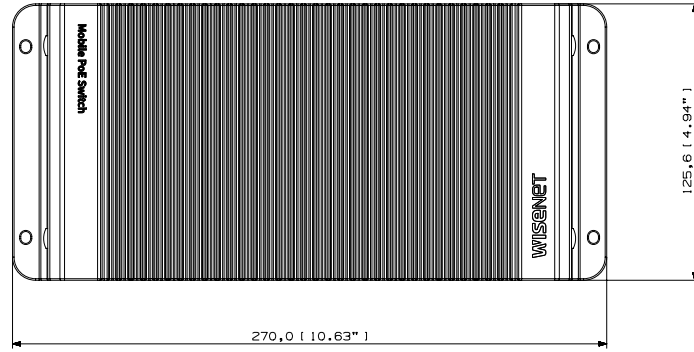

- SPN-10080PM

unit : mm (inches)

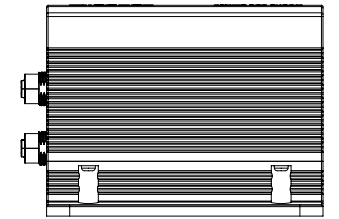
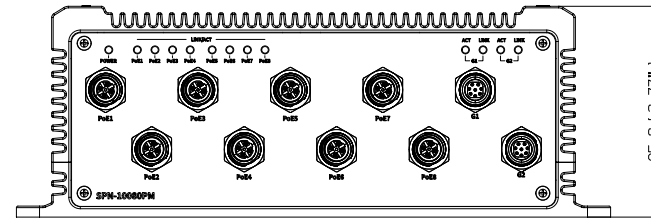
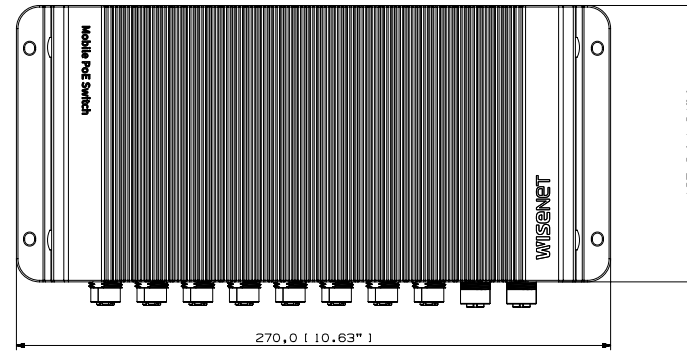

Head Office

6, Pangyo-ro 319 beon-gil, Bundang-gu, Seongnam-si,
Gyeonggi-do, 463-400 Rep. of KOREA

Tel : +82.70.7147.8753 Fax : +82.31.8018.3740

www.hanwha-security.com

Hanwha Techwin America

500 Frank W. Burr Blvd. Suite 43 Teaneck, NJ 07666

Toll Free +1.877.213.1222 Direct +1.201.325.6920

Fax +1.201.373.0124

www.hanwha-security.com

Hanwha Techwin Europe

Heriot House, Heriot Road, Chertsey, Surrey, KT16 9DT, United Kingdom

Tel +44.1932.57.8100 Fax +44.1932.57.8101

www.hanwha-security.eu
