

# EMC TEST REPORT For VCCI

Test Report No. : KES-E1-17T0644  
Date of Issue : Sep. 21, 2017  
Product name : PoE Switch  
Model/Type No. : SPN-10080P  
Variant Model : -  
Applicant : Hanwha Techwin Co., Ltd.  
Applicant Address : 1204, Changwon-daero, Seongsan-gu Changwon-si,  
Gyeongsangnam-do, Korea  
Manufacturer : Hanwha Techwin (Tianjin) Co., Ltd.  
Manufacturer Address : No.11 Weiliu Rd, Micro-Electronic Industrial  
Park, TEDA, Tianjin, 300385, People's Republic of China  
Equipment authorization :  Declaration of Conformity  
 Verification  
 Certification  
Date of Receipt : Sep. 06, 2017  
Test date : Sep. 16, 2017  
Test Results :  In Compliance  Not in Compliance

Tested by



Young Jun, Jo  
EMC Test Engineer

Reviewed by



Dong-Hun, Jang  
EMC Technical Manager

This test report is not related to KOLAS.



**KES Co., Ltd.**

C-3701, Simin-daero 365-40,  
Dongan-gu, Anyang-si, Gyeonggi-do, 14057, Korea  
Tel: +82-31-425-6200 / Fax: +82-31-424-0450  
www.kes.co.kr

Test report No.:  
KES-E1-17T0644  
Page (2) of (37)

---

## REPORT REVISION HISTORY

Date	Test Report No.	Revision History
Sep. 21, 2017	KES-E1-17T0644	Issued

*This report shall not be reproduced except in full, without the written approval of KES Co., Ltd. This document Sep be altered or revised by KES Co., Ltd. personnel only, and shall be noted in the revision section of the document. Any alteration of this document not carried out by KES Co., Ltd. will constitute fraud and shall nullify the document.*

---

This report shall not be reproduced except in full, without the written approval of KES Co., Ltd.  
The results shown in this test report refer only to the sample(s) tested unless otherwise stated.



---

## TABLE OF CONTENTS

1.0	General Product Description.....	4
1.1	Test Voltage & Frequency .....	5
1.2	Variant Model Differences.....	5
1.3	Device Modifications .....	5
1.4	Equipment Under Test.....	5
1.5	Support Equipments .....	5
1.6	External I/O Cabling .....	6
1.7	EUT Operating Mode(s) .....	6
1.8	Configuration.....	7
1.9	Remarks when standards applied .....	8
1.10	Calibration Details of Equipment Used for Measurement .....	8
1.11	Test Facility .....	8
1.12	Laboratory Accreditations and Listings .....	8
2.0	Test Regulations.....	9
2.1	Conducted Emissions Mains Power Ports.....	11
2.2	Conducted Emissions at Telecommunication Ports.....	12
2.3	Radiated Electric Field Emissions(Below 1 GHz) .....	13
2.4	Radiated Electric Field Emissions(Above 1 GHz) .....	14
APPENDIX A – TEST DATA.....		15
	Conducted Emissions at Mains Power Ports.....	15
	Conducted Emissions at Telecommunication Ports .....	17
	Radiated Electric Field Emissions(Below 1 GHz) .....	23
	Radiated Electric Field Emissions(Above 1 GHz) .....	24
	Test Setup Photos and Configuration .....	28
	Conducted Voltage Emissions .....	28
	Conducted Telecommunication Emissions .....	29
	Radiated Electric Field Emissions(Below 1 GHz) .....	31
	Radiated Electric Field Emissions(Above 1 GHz) .....	32
	EUT External Photographs.....	33
	EUT Internal Photographs .....	34



## 1.0 General Product Description

Main Specifications of EUT are:

<b>PoE</b>	
Maximum PoE Budget	64W
PoE Standard	IEEE 802.3af / 802.3at
PoE/PoE+ Ports	Port 1 ~ 8 : PoE/PoE+
<b>Compatible Devices</b>	
Network CCTV Devices	WiseNet Network Cameras, TRM NVR Series
<b>Interface</b>	
1000Base-T Interface	2 (M12, A-Code, 8P Female)
100Base-T PoE Interface	8 (M12, D-Code, 4P Female)
MDI/MDIX adjustable	Yes
Power Input	Molex 6P -> 6P Gender Included
<b>Indicator</b>	
LED	Power Status : 1 -> 0 Ethernet : Link 10-> 2, ACT 10 ->2 PoE Status : 8 -> PoE Link: 8
<b>General</b>	
Dimension (W x D x H)	270 x 134 x 93mm
Weight	TBD
Operation Temperature	-20 ~ 55°C
Operation/Storage Humidity	0% - 95% RH
Maximum Power Consumption	TBD
Power Input	9 ~ 36 VDC (Fanless)
Color/Material	Black / Al
Imgression	X

This report shall not be reproduced except in full, without the written approval of KES Co., Ltd.  
The results shown in this test report refer only to the sample(s) tested unless otherwise stated.



## 1.1 Test Voltage & Frequency

Unless indicated otherwise on the individual data sheet or test results, the test voltage and frequency was as indicated below.

Voltage       230 Vac    100 Vac    24 Vac    12 Vdc    PoE  
Frequency     50 Hz     60 Hz            Hz

## 1.2 Variant Model Differences

Not applicable

## 1.3 Device Modifications

Not applicable

## 1.4 Equipment Under Test

Description	Model Number	Serial Number	Manufacturer	Remarks
PoE Switch	SPN-10080P	-	Hanwha Techwin (Tianjin) Co.,Ltd.	E.U.T

## 1.5 Support Equipments

Description	Model Number	Serial Number	Manufacturer	Remarks
Notebook	NT63025J	JK9091EF400432X	SAMSUNG Electronics Co., Ltd.	-
Notebook AC/DC adapter	A13-040N2A	-	Chicony Power Technbology Co., Ltd.	-
PoE Camera 1	-	-	SAMSUNG	-
PoE Camera 2	RS-CH292H3C-36P-ST	-	SAMSUNG	7 EA

This report shall not be reproduced except in full, without the written approval of KES Co., Ltd.  
The results shown in this test report refer only to the sample(s) tested unless otherwise stated.

## 1.6 External I/O Cabling

Start		END		Cable Spec.	
Description	I/O Port	Description	I/O Port	Length	Shield
PoE Switch (E.U.T)	RJ-45	Notebook	RJ-45	3.5	S
	RJ-45	PoE Camera 1	RJ-45	3.5	S
	RJ-45	PoE Camera 2	RJ-45	5.0	S
	RJ-45	PoE Camera 2	RJ-45	5.0	S
	RJ-45	PoE Camera 2	RJ-45	5.0	S
	RJ-45	PoE Camera 2	RJ-45	5.0	S
	RJ-45	PoE Camera 2	RJ-45	5.0	S
	RJ-45	PoE Camera 2	RJ-45	5.0	S
	RJ-45	PoE Camera 2	RJ-45	5.0	S

\* Unshielded=U, Shielded=S

## 1.7 EUT Operating Mode(s)

Test mode	operating
Normal Operating	Check the video output of the camera & Ping test

E.U.T Test operating S/W		
Name	Version	Manufacture Company
-	-	-

This report shall not be reproduced except in full, without the written approval of KES Co., Ltd.  
 The results shown in this test report refer only to the sample(s) tested unless otherwise stated.

## 1.8 Configuration

■ AC Main  
□ DC Main

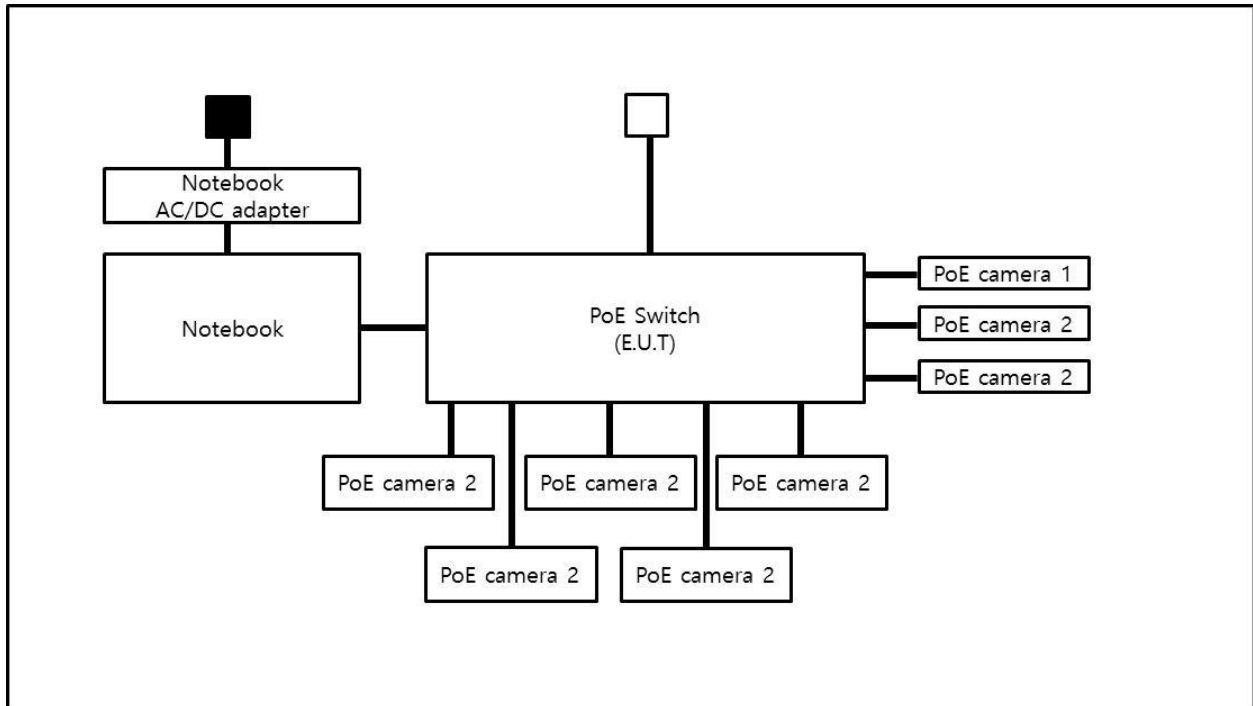

This report shall not be reproduced except in full, without the written approval of KES Co., Ltd.  
The results shown in this test report refer only to the sample(s) tested unless otherwise stated.

## 1.9 Remarks when standards applied

N/A







## 1.10 Calibration Details of Equipment Used for Measurement

Test equipment and test accessories are calibrated on regular basis. The maximum time between calibrations is one year or what is recommended by the manufacturer, whichever is less.

## 1.11 Test Facility

The measurement facility is located at 473-21 Gayeo-ro, Yeosu-si, Gyeonggi-do, 12658, Korea. The sites are constructed in conformance with the requirements of ANSI C63.4 and CISPR Publication 22.

## 1.12 Laboratory Accreditations and Listings

Country	Agency	Scope of Accreditation	Logo
USA	FCC	3 & 10 meter Open Area Test Sites and one conducted site to perform FCC Part 15/18 measurements.	
JAPAN	VCCI	Mains Ports Conducted Interference Measurement, Telecommunication Ports Conducted Disturbance Measurement and Radiation 10 meter site, Facility for measuring radiated disturbance above 1 GHz	 R-4308, C-4798, T-2311, G-914
KOREA	MSIP	EMI (10 meter Open Area Test Site and two conducted sites) Radio(3 & 10 meter Open Area Test Sites and one conducted site) EMS (ESD, RS, EFT/Burst, Surge, CS, Magnetic, Dips and interruptions)	 KR0100
Canada	IC	3 & 10 meter Open Area Test Sites and one conducted site	 4769B-1
Europe	CE	EMI (10 meter Open Area Test Site and two conducted sites) Radio(3 & 10 meter Open Area Test Sites and one conducted site) EMS (ESD, RS, EFT/Burst, Surge, CS, Magnetic, Dips and interruptions)	
International	KOLAS	EMI (10 meter Open Area Test Site and two conducted sites) Radio(3 & 10 meter Open Area Test Sites and one conducted site) EMS (ESD, RS, EFT/Burst, Surge, CS, Magnetic, Dips and interruptions)	

This report shall not be reproduced except in full, without the written approval of KES Co., Ltd.  
The results shown in this test report refer only to the sample(s) tested unless otherwise stated.



## 2.0 Test Regulations

The emissions tests were performed according to following regulations:

EMC – Directive 2014/30/EU

EN 61000-6-3: 2011

EN 61000-6-1: 2007

EN 61000-6-4: 2007 +A1: 2011

EN 61000-6-2: 2005

EN 55011: 2007 +A1: 2010

Group 1  
 Class A

Group 2  
 Class B

EN 55014-1: 2006 +A2: 2011

EN 55014-2: 1997 +A2: 2008

EN 55015: 2013

EN 61547 : 2009

EN 55032: 2015

Class A

Class B

EN 55024: 2010 +A1: 2015

EN 50130-4: 2011 +A1: 2014

EN 61000-3-2: 2014

EN 61000-3-3: 2013

EN 61326-1: 2013



**KES Co., Ltd.**

C-3701, Simin-daero 365-40,  
Dongan-gu, Anyang-si, Gyeonggi-do, 14057, Korea  
Tel: +82-31-425-6200 / Fax: +82-31-424-0450  
www.kes.co.kr

Test report No.:  
KES-E1-17T0644  
Page (10) of (37)

- 
- |  |   |                                  |
|--|---|----------------------------------|
| <input checked="" type="checkbox"/> VCCI V-3 / 2015.04 | <input checked="" type="checkbox"/> Class A | <input type="checkbox"/> Class B |
| <input type="checkbox"/> AS/NZS CISPR22:2009 +A1:2010  | <input type="checkbox"/> Class A            | <input type="checkbox"/> Class B |
| <input type="checkbox"/> 47 CFR Part 15, Subpart B     |   |                                  |
| <input type="checkbox"/> CISPR 22: 2009 +A1: 2010      | <input type="checkbox"/> Class A            | <input type="checkbox"/> Class B |
| <input type="checkbox"/> ANSI C63.4-2009               |   |                                  |
| <input type="checkbox"/> IC Regulation ICES-003 : 2016 |   |                                  |
| <input type="checkbox"/> CAN/CSA CISPR 22-10           | <input type="checkbox"/> Class A            | <input type="checkbox"/> Class B |
| <input type="checkbox"/> ANSI C63.4-2014               |   |                                  |
| <br>   |   |                                  |
| <input type="checkbox"/> RE- Directive 2014/53/EU      |   |                                  |
| <br>   |   |                                  |
| <input type="checkbox"/> EN 301 489-1 V1.9.2           |   |                                  |
| <input type="checkbox"/> Equipment for fixed use       |   |                                  |
| <input type="checkbox"/> Equipment for vehicular use   |   |                                  |
| <input type="checkbox"/> Equipment for portable use    |   |                                  |
| <br>   |   |                                  |
| <input type="checkbox"/> EN 301 489-3 V1.6.1           |   |                                  |
| <br>   |   |                                  |
| <input type="checkbox"/> EN 301 489-17 V2.2.1          |   |                                  |
| <br>   |   |                                  |
| <input type="checkbox"/> EN 60945: 2002                |   |                                  |

---

This report shall not be reproduced except in full, without the written approval of KES Co., Ltd.  
The results shown in this test report refer only to the sample(s) tested unless otherwise stated.



## 2.1 Conducted Emissions Mains Power Ports

Test Date  
N/A

Test Location  
Electro wave Shieldroom

Test Equipment

Used	Description	Model Number	Manufacturer	Serial Number	Cal. Due
<input type="checkbox"/>	EMI Test S/W	EMC32	R & S	9.12.00	-
<input type="checkbox"/>	EMI TEST RECEIVER	ESR3	R & S	101783	04, 27, 2018
<input type="checkbox"/>	LISN	ENV216	R & S	101137	02, 03, 2018
<input type="checkbox"/>	LISN	ENV216	R & S	101786	04, 27, 2018
<input type="checkbox"/>	PULSE LIMITER	ESH3-Z2	R & S	101914	12, 13, 2017

Test Conditions

Temperature: °C  
Relative Humidity: %

Frequency Range of Measurement  
150 kHz to 30 MHz

Instrument Settings

IF Band Width: 9 kHz

Test Results

The requirements are:

- PASS
- NOT PASS
- NOT APPLICABLE

Remarks

N/A

## 2.2 Conducted Emissions at Telecommunication Ports

Test Date  
 Sep. 16, 2017

Test Location  
 Electro wave Shieldroom

### Test Equipment

Used	Description	Model Number	Manufacturer	Serial Number	Cal. Due
<input checked="" type="checkbox"/>	EMI Test S/W	EMC32	R & S	9.12.00	-
<input checked="" type="checkbox"/>	EMI TEST RECEIVER	ESR3	R & S	101783	04, 27, 2018
<input checked="" type="checkbox"/>	LISN	ENV216	R & S	101137	02, 03, 2018
<input checked="" type="checkbox"/>	LISN	ENV216	R & S	101786	04, 27, 2018
<input checked="" type="checkbox"/>	PULSE LIMITER	ESH3-Z2	R & S	101914	12, 13, 2017
<input checked="" type="checkbox"/>	ISN	ISN S8	SCHWARZBECK	ISN-S8-0019	05, 12, 2018

### Test Conditions

Temperature: 23,0 °C  
 Relative Humidity: 52,1 %

### Frequency Range of Measurement

150 kHz to 30 MHz

### Instrument Settings

IF Band Width: 9 kHz

### Test Results

The requirements are:

- PASS
- NOT PASS
- NOT APPLICABLE

### Remarks

See Appendix A for test data.



## 2.3 Radiated Electric Field Emissions(Below 1 GHz)

Test Date  
Sep. 16, 2017

Test Location  
 OPEN AREA TEST SITE #1       OPEN AREA TEST SITE #2

### Test Equipment

Used	Description	Model Number	Manufacturer	Serial Number	Cal. Due
<input checked="" type="checkbox"/>	EMI TEST RECEIVER	ESVS10	Rohde & Schwarz	826008/014	04, 18, 2018
<input checked="" type="checkbox"/>	TRILOG-BROADBAND ANTENNA	VULB9163	Schwarzbeck	715	04, 14, 2018

Test Conditions  
Temperature: 25,7°C  
Relative Humidity: 54,0 %

Frequency Range of Measurement  
30 MHz to 1 GHz

Instrument Settings  
IF Band Width: 120 kHz

Test Results  
The requirements are:

- PASS
- NOT PASS
- NOT APPLICABLE

Remarks  
See Appendix A for test data.



## 2.4 Radiated Electric Field Emissions(Above 1 GHz)

Test Date  
Sep. 16, 2017

Test Location  
SEMI ANECHOIC CHAMBER #2

### Test Equipment

Used	Description	Model Number	Manufacturer	Serial Number	Cal. Due
<input checked="" type="checkbox"/>	EMI Test S/W	e3	AUDIX	8.083b	-
<input checked="" type="checkbox"/>	PREAMPLIFIER	8449B	AGILENT	3008A01729	05, 31, 2018
<input type="checkbox"/>	ATTENUATOR	8491A	HP	35496	05, 31, 2018
<input checked="" type="checkbox"/>	LOG-PERIODIC ANTENNA	STLP 9149	SCHWARZBECK	9149-255	05, 17, 2018

### Test Conditions

Temperature: 23,0 °C  
Relative Humidity: 52,1 %

Frequency Range of Measurement  
1 GHz to 6 GHz

### Instrument Settings

IF Band Width: 1 MHz

### Test Results

The requirements are:

- PASS
- NOT PASS
- NOT APPLICABLE

### Remarks

See Appendix A for test data.



**KES Co., Ltd.**

C-3701, Simin-daero 365-40,  
Dongan-gu, Anyang-si, Gyeonggi-do, 14057, Korea  
Tel: +82-31-425-6200 / Fax: +82-31-424-0450  
www.kes.co.kr

Test report No.:  
KES-E1-17T0644  
Page (15) of (37)

---

## APPENDIX A – TEST DATA

### Conducted Emissions at Mains Power Ports

[HOT]

N/A

---

This report shall not be reproduced except in full, without the written approval of KES Co., Ltd.  
The results shown in this test report refer only to the sample(s) tested unless otherwise stated.



**KES Co., Ltd.**

C-3701, Simin-daero 365-40,  
Dongan-gu, Anyang-si, Gyeonggi-do, 14057, Korea  
Tel: +82-31-425-6200 / Fax: +82-31-424-0450  
www.kes.co.kr

Test report No.:  
KES-E1-17T0644  
Page (16) of (37)

---

[NEUTRAL]

N/A

◆ Calculation

QuasiPeak[dBuV] / CAverage [dBuV] = Reading Value[dBuV] + Corr. [dB]

QuasiPeak / CAverage : The Final Value

Reading Value : Not shown in the table.

Corr. : Correction values (LISN FACTOR + (Cable Loss + Pulse Limiter FACTOR))

---

This report shall not be reproduced except in full, without the written approval of KES Co., Ltd.  
The results shown in this test report refer only to the sample(s) tested unless otherwise stated.



## Conducted Emissions at Telecommunication Ports

- LAN Mode

[10 Mbps]

### Common Information

Test Description:	Telecommunication Emission
Model No.:	SPN-10080P
Mode	LAN 10 Mbps
Operator Name:	KES

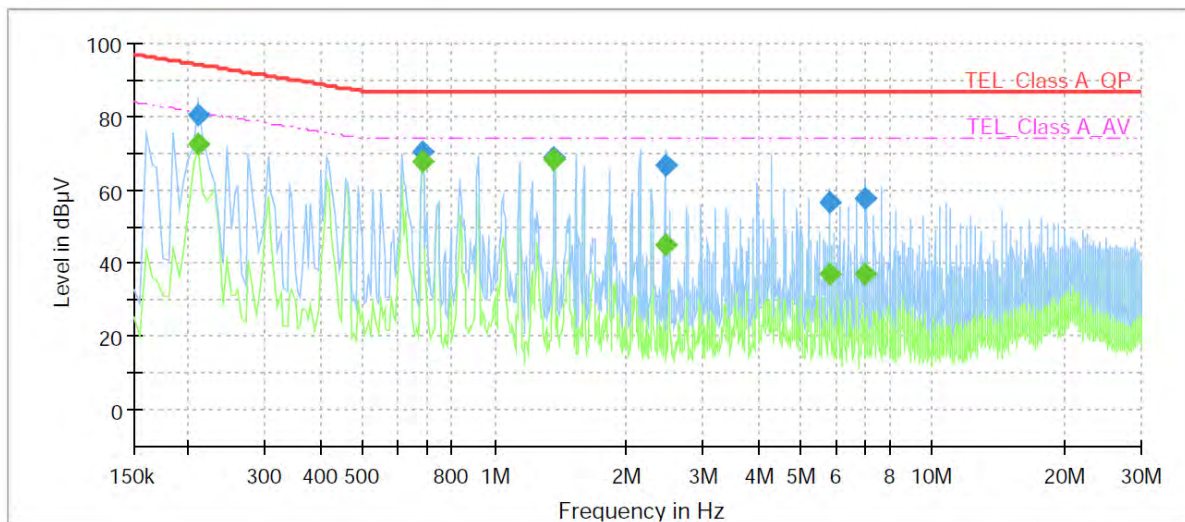

### Final Result

Frequency (MHz)	QuasiPeak (dBµV)	CAverage (dBµV)	Limit (dBµV)	Margin (dB)	Meas. Time (ms)	Bandwidth (kHz)	Line	Corr. (dB)
0.210000	---	72.31	81.21	8.90	1000.0	9.000	Single Line	19.4
0.210000	80.54	---	94.21	13.67	1000.0	9.000	Single Line	19.4
0.685000	---	67.60	74.00	6.40	1000.0	9.000	Single Line	19.6
0.685000	70.31	---	87.00	16.69	1000.0	9.000	Single Line	19.6
1.370000	---	68.12	74.00	5.88	1000.0	9.000	Single Line	19.7
1.370000	68.89	---	87.00	18.11	1000.0	9.000	Single Line	19.7
2.450000	---	45.26	74.00	28.74	1000.0	9.000	Single Line	19.8
2.450000	66.92	---	87.00	20.08	1000.0	9.000	Single Line	19.8
5.820000	---	36.99	74.00	37.01	1000.0	9.000	Single Line	19.7
5.820000	56.81	---	87.00	30.19	1000.0	9.000	Single Line	19.7
7.050000	---	36.93	74.00	37.07	1000.0	9.000	Single Line	19.6
7.050000	57.55	---	87.00	29.45	1000.0	9.000	Single Line	19.6

This report shall not be reproduced except in full, without the written approval of KES Co., Ltd.  
 The results shown in this test report refer only to the sample(s) tested unless otherwise stated.

[100 Mbps]

## Common Information

Test Description:	Telecommunication Emission
Model No.:	SPN-10080P
Mode	LAN 100 Mbps
Operator Name:	KES

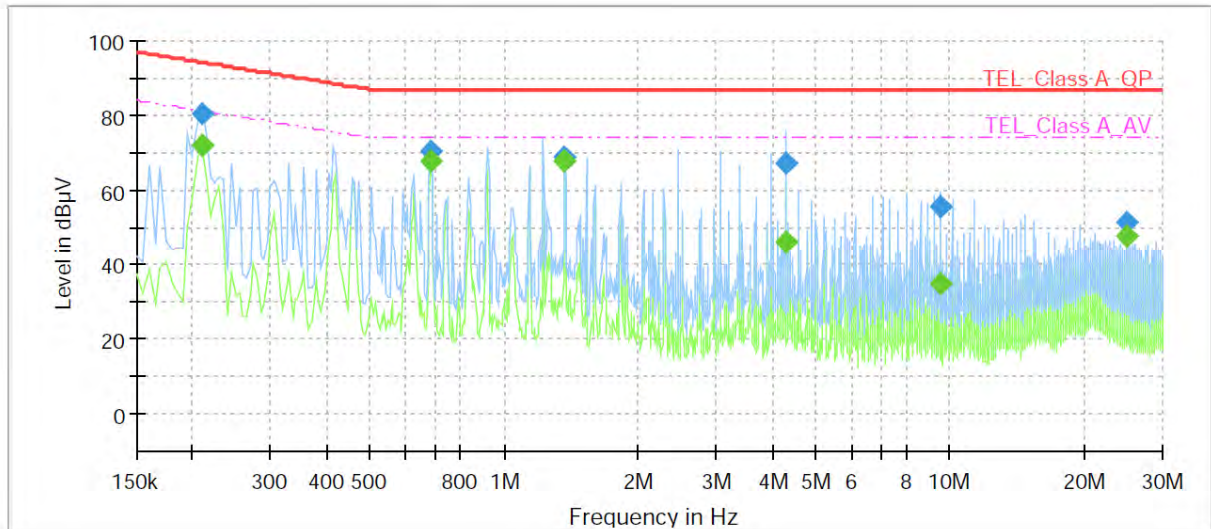

## Final Result

Frequency (MHz)	QuasiPeak (dBµV)	CAverage (dBµV)	Limit (dBµV)	Margin (dB)	Meas. Time (ms)	Bandwidth (kHz)	Line	Corr. (dB)
0.210000	---	71.95	81.21	9.26	1000.0	9.000	Single Line	19.4
0.210000	80.65	---	94.21	13.56	1000.0	9.000	Single Line	19.4
0.685000	---	67.54	74.00	6.46	1000.0	9.000	Single Line	19.6
0.685000	70.24	---	87.00	16.76	1000.0	9.000	Single Line	19.6
1.370000	---	67.94	74.00	6.06	1000.0	9.000	Single Line	19.7
1.370000	68.81	---	87.00	18.19	1000.0	9.000	Single Line	19.7
4.295000	---	46.00	74.00	28.00	1000.0	9.000	Single Line	19.7
4.295000	67.43	---	87.00	19.57	1000.0	9.000	Single Line	19.7
9.500000	---	35.09	74.00	38.91	1000.0	9.000	Single Line	19.6
9.500000	55.43	---	87.00	31.57	1000.0	9.000	Single Line	19.6
25.000000	---	47.90	74.00	26.10	1000.0	9.000	Single Line	19.9
25.000000	51.13	---	87.00	35.87	1000.0	9.000	Single Line	19.9

This report shall not be reproduced except in full, without the written approval of KES Co., Ltd.  
 The results shown in this test report refer only to the sample(s) tested unless otherwise stated.

[1000 Mbps]

## Common Information

Test Description:	Telecommunication Emission
Model No.:	SPN-10080P
Mode	LAN 1 000 Mbps
Operator Name:	KES

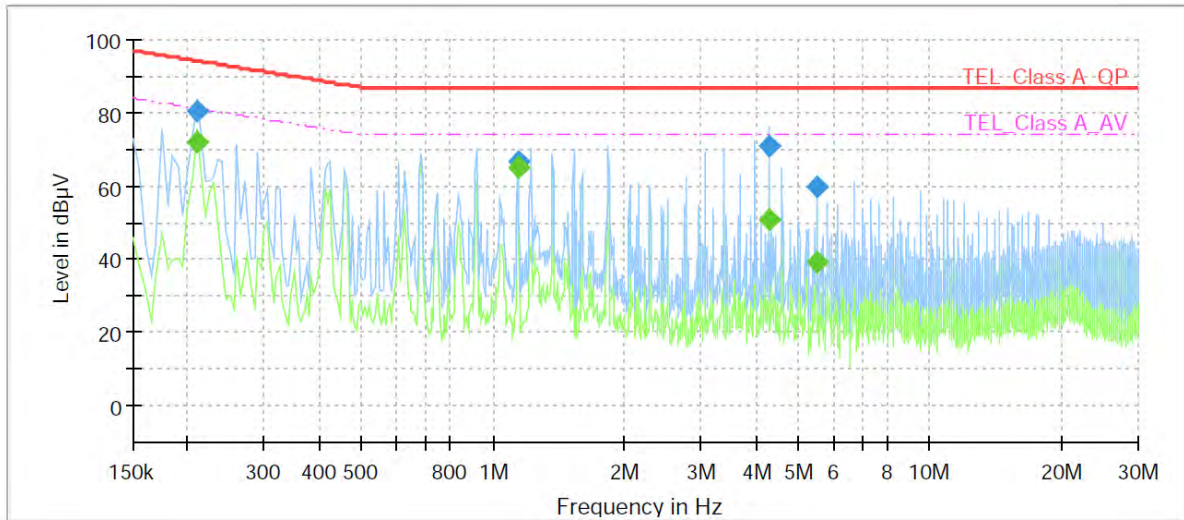

## Final Result

Frequency (MHz)	QuasiPeak (dBµV)	CAverage (dBµV)	Limit (dBµV)	Margin (dB)	Meas. Time (ms)	Bandwidth (kHz)	Line	Corr. (dB)
0.210000	---	71.89	81.21	9.32	1000.0	9.000	Single Line	19.4
0.210000	80.56	---	94.21	13.65	1000.0	9.000	Single Line	19.4
1.140000	---	65.10	74.00	8.90	1000.0	9.000	Single Line	19.7
1.140000	66.83	---	87.00	20.17	1000.0	9.000	Single Line	19.7
4.290000	---	50.88	74.00	23.12	1000.0	9.000	Single Line	19.7
4.290000	70.76	---	87.00	16.24	1000.0	9.000	Single Line	19.7
5.515000	---	39.18	74.00	34.82	1000.0	9.000	Single Line	19.7
5.515000	60.01	---	87.00	26.99	1000.0	9.000	Single Line	19.7

This report shall not be reproduced except in full, without the written approval of KES Co., Ltd.  
 The results shown in this test report refer only to the sample(s) tested unless otherwise stated.



- PoE Mode

[10 Mbps]

## Common Information

Test Description:	Telecommunication Emission
Model No.:	SPN-10080P
Mode	POE 10 Mbps
Operator Name:	KES

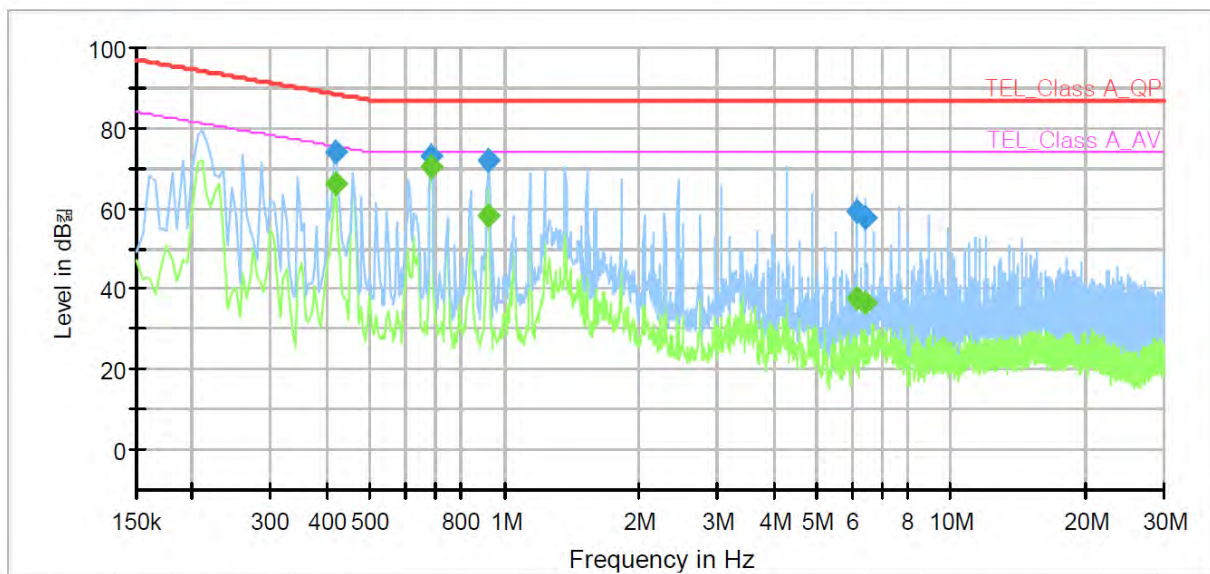

## Final Result

Frequency (MHz)	QuasiPeak (dB <sub>μV</sub> )	CAverage (dB <sub>μV</sub> )	Limit (dB <sub>μV</sub> )	Margin (dB)	Meas. Time (ms)	Bandwidth (kHz)	Line	Corr. (dB)
0.420000	---	66.32	75.45	9.13	1000.0	9.000	Single Line	19.5
0.420000	74.19	---	88.45	14.26	1000.0	9.000	Single Line	19.5
0.685000	---	70.52	74.00	3.48	1000.0	9.000	Single Line	19.6
0.685000	73.15	---	87.00	13.85	1000.0	9.000	Single Line	19.6
0.920000	---	58.12	74.00	15.88	1000.0	9.000	Single Line	19.7
0.920000	71.82	---	87.00	15.18	1000.0	9.000	Single Line	19.7
6.130000	---	37.76	74.00	36.24	1000.0	9.000	Single Line	19.7
6.130000	59.34	---	87.00	27.66	1000.0	9.000	Single Line	19.7
6.435000	---	36.65	74.00	37.35	1000.0	9.000	Single Line	19.7
6.435000	57.90	---	87.00	29.10	1000.0	9.000	Single Line	19.7

This report shall not be reproduced except in full, without the written approval of KES Co., Ltd.  
The results shown in this test report refer only to the sample(s) tested unless otherwise stated.

[100 Mbps]

### Common Information

Test Description:	Telecommunication Emission
Model No.:	SPN-10080P
Mode	POE 100 Mbps
Operator Name:	KES

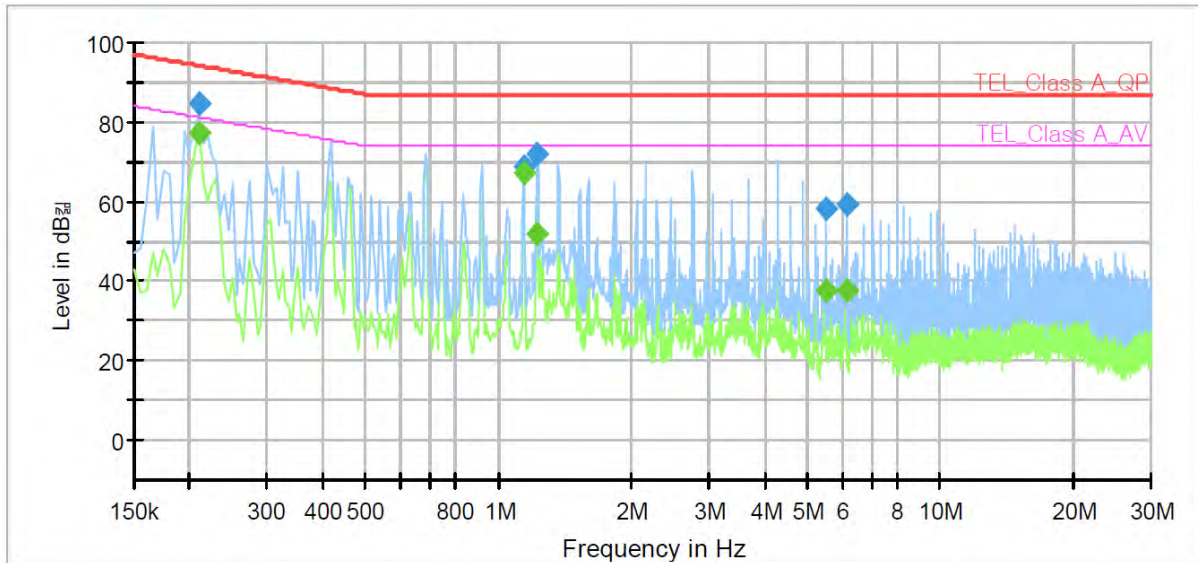

### Final\_Result

Frequency (MHz)	QuasiPeak (dB <sub>μV</sub> )	CAverage (dB <sub>μV</sub> )	Limit (dB <sub>μV</sub> )	Margin (dB)	Meas. Time (ms)	Bandwidth (kHz)	Line	Corr. (dB)
0.210000	---	77.01	81.21	4.20	1000.0	9.000	Single Line	19.4
0.210000	84.42	---	94.21	9.79	1000.0	9.000	Single Line	19.4
1.140000	---	67.07	74.00	6.93	1000.0	9.000	Single Line	19.7
1.140000	68.69	---	87.00	18.31	1000.0	9.000	Single Line	19.7
1.225000	---	52.03	74.00	21.97	1000.0	9.000	Single Line	19.7
1.225000	71.93	---	87.00	15.07	1000.0	9.000	Single Line	19.7
5.515000	---	37.70	74.00	36.30	1000.0	9.000	Single Line	19.7
5.515000	58.10	---	87.00	28.90	1000.0	9.000	Single Line	19.7
6.130000	---	37.44	74.00	36.56	1000.0	9.000	Single Line	19.7
6.130000	59.25	---	87.00	27.75	1000.0	9.000	Single Line	19.7

This report shall not be reproduced except in full, without the written approval of KES Co., Ltd.  
 The results shown in this test report refer only to the sample(s) tested unless otherwise stated.

[1000 Mbps]

## Common Information

Test Description:	Telecommunication Emission
Model No.:	SPN-10080P
Mode	POE 1 000 Mbps
Operator Name:	KES

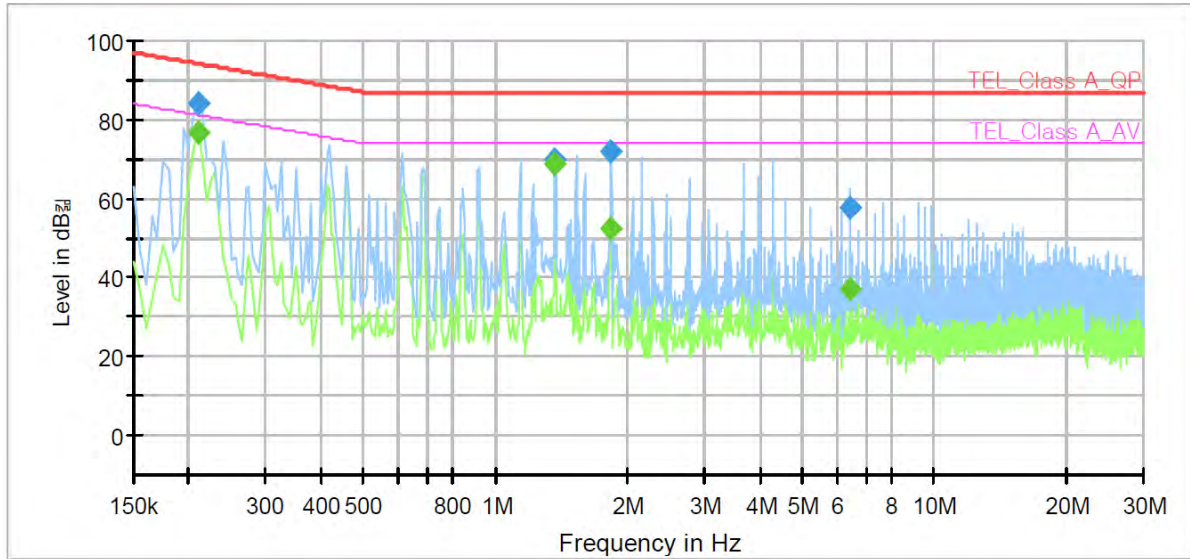

## Final Result

Frequency (MHz)	QuasiPeak (dB $\mu$ V)	CAverage (dB $\mu$ V)	Limit (dB $\mu$ V)	Margin (dB)	Meas. Time (ms)	Bandwidth (kHz)	Line	Corr. (dB)
0.210000	---	76.80	81.21	4.41	1000.0	9.000	Single Line	19.4
0.210000	84.27	---	94.21	9.94	1000.0	9.000	Single Line	19.4
1.370000	---	69.01	74.00	4.99	1000.0	9.000	Single Line	19.7
1.370000	70.09	---	87.00	16.91	1000.0	9.000	Single Line	19.7
1.840000	---	52.18	74.00	21.82	1000.0	9.000	Single Line	19.8
1.840000	71.87	---	87.00	15.13	1000.0	9.000	Single Line	19.8
6.435000	---	37.32	74.00	36.68	1000.0	9.000	Single Line	19.7
6.435000	57.76	---	87.00	29.24	1000.0	9.000	Single Line	19.7

### ◆ Calculation

QuasiPeak[dBuV] / CAverage [dBuV] = Reading Value[dBuV] + Corr. [dB]

QuasiPeak / CAverage : The Final Value

Reading Value : Not shown in the table.

Corr. : Correction values (ISN FACTOR + (Cable Loss + Pulse Limiter FACTOR))

This report shall not be reproduced except in full, without the written approval of KES Co., Ltd.  
The results shown in this test report refer only to the sample(s) tested unless otherwise stated.



Radiated Electric Field Emissions(Below 1 GHz)

Frequency [MHz]	Amplitude [dB $\mu$ V]	ANT Polar. (H/V)	ANT. Height [m]	Correction Factor		Corrected Amplitude [dB $\mu$ V/m]	Applicable Limit [dB $\mu$ V/m]	Margin [dB]
				ANT. [dB/m]	Cable [dB]			
248.69	17.40	V	1.20	12.52	3.55	33.47	47.00	13.53
299.36	20.00	H	4.00	13.39	3.87	37.26	47.00	9.74
348.58	15.80	H	3.93	14.45	4.19	34.44	47.00	12.56
370.09	18.30	V	1.00	14.92	4.37	37.59	47.00	9.41
483.96	13.10	H	4.00	17.02	5.25	35.37	47.00	11.63
525.18	11.20	H	3.86	17.80	5.39	34.39	47.00	12.61

\* H : Horizontal, V : Vertical

◆ Calculation

Corrected Amplitude [dB $\mu$ V] = Amplitude[dBuV] + Correction Factor [dB]

Corrected Amplitude : The Final Value, Amplitude : Reading Value,

Correction Factor : ANT FACTOR + Cable loss

This report shall not be reproduced except in full, without the written approval of KES Co., Ltd.  
 The results shown in this test report refer only to the sample(s) tested unless otherwise stated.





Radiated Electric Field Emissions(Above 1 GHz)

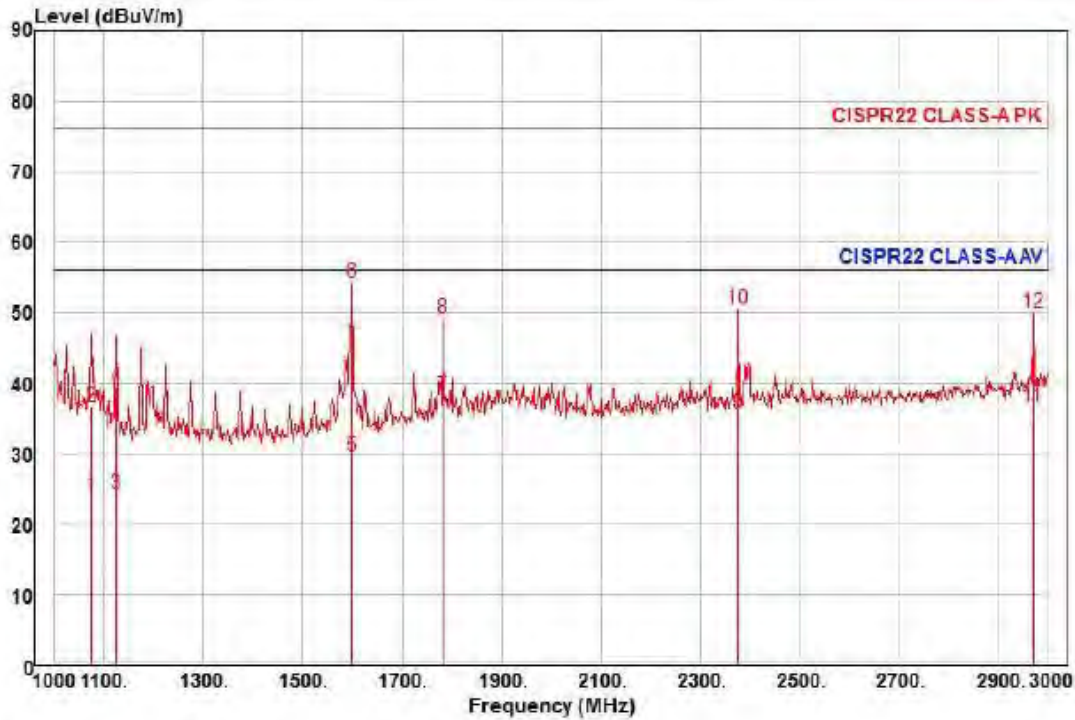

Site : YEOJU\_C 3 m SAC  
 Condition: CISPR22 CLASS-A PK 3m STLP9149(RRA CAL 2017-05-18) horizontal  
 : RBW:1000.000kHz VBW:1000.000kHz SWT:Auto  
 Project :  
 Model : SPN-10080P  
 Mode :  
 Memo : 1 - 3 GHz

	Read	Ant	Cable	Preamp	TPos	Limit	Over		
Freq	Level	Factor	Loss	Factor		Line	Limit	Pol/Phase	Remark
MHz	dBuV	dB/m	dB	dB	deg	dBuV/m	dB		
1	1074.00	30.53	22.72	6.88	35.99	196	56.00	-31.86	horizontal Average
2	1074.00	43.01	22.72	6.88	35.99	196	76.00	-39.38	horizontal Peak
3	1124.00	30.26	22.88	7.04	35.95	151	56.00	-31.77	horizontal Average
4	1124.00	45.40	22.88	7.04	35.95	151	76.00	-36.63	horizontal Peak
5	1598.00	32.31	24.41	8.50	35.53	286	56.00	-26.31	horizontal Average
6 pk	1598.00	56.93	24.41	8.50	35.53	286	76.00	-21.69	horizontal Peak
7 pp	1782.00	39.47	25.14	9.04	35.36	254	56.00	-17.71	horizontal Average
8	1782.00	50.38	25.14	9.04	35.36	254	76.00	-26.80	horizontal Peak
9	2376.00	33.28	27.15	10.54	35.32	136	56.00	-20.35	horizontal Average
10	2376.00	48.18	27.15	10.54	35.32	136	76.00	-25.45	horizontal Peak
11	2970.00	30.46	29.61	12.06	35.55	67	56.00	-19.42	horizontal Average
12	2970.00	43.85	29.61	12.06	35.55	67	76.00	-26.03	horizontal Peak

This report shall not be reproduced except in full, without the written approval of KES Co., Ltd.  
 The results shown in this test report refer only to the sample(s) tested unless otherwise stated.



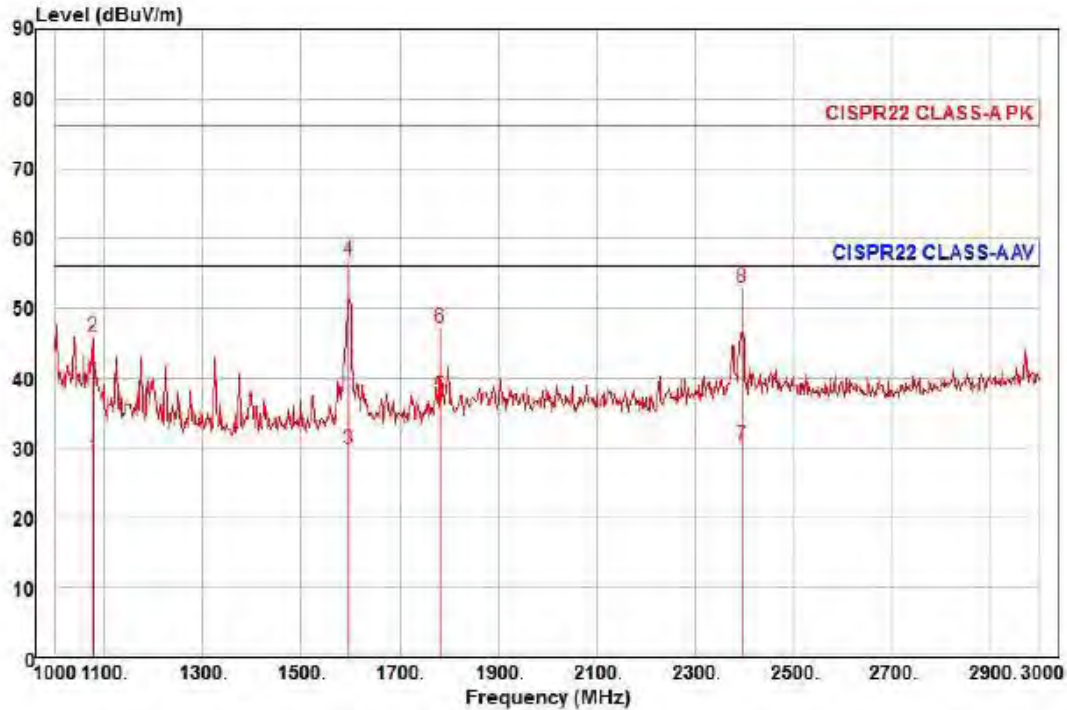

Site : YEOJU\_C 3 m SAC  
 Condition: CISPR22 CLASS-A PK 3m STLP9149(RRA CAL 2017-05-18) vertical  
 : RBW:1000.000kHz VBW:1000.000kHz SWT:Auto  
 Project :  
 Model : SPN-10080P  
 Mode :  
 Memo : 1 - 3 GHz

	Freq	Read Level	Ant Factor	Cable Loss	Preamp Factor	TPos	Limit Line	Over Limit	Pol/Phase	Remark
	MHz	dBuV	dB/m	dB	dB	deg	dBuV/m	dB		
1	1076.00	35.04	22.73	6.88	35.99	68	56.00	-27.34	vertical	Average
2	1076.00	52.36	22.73	6.88	35.99	68	76.00	-30.02	vertical	Peak
3	1596.00	32.51	24.40	8.49	35.53	4	56.00	-26.13	vertical	Average
4 pk	1596.00	59.43	24.40	8.49	35.53	4	76.00	-19.21	vertical	Peak
5 pp	1782.00	38.61	25.14	9.04	35.36	80	56.00	-18.57	vertical	Average
6	1782.00	48.51	25.14	9.04	35.36	80	76.00	-28.67	vertical	Peak
7	2396.00	27.84	27.21	10.58	35.32	96	56.00	-25.69	vertical	Average
8	2396.00	50.54	27.21	10.58	35.32	96	76.00	-22.99	vertical	Peak

This report shall not be reproduced except in full, without the written approval of KES Co., Ltd.  
 The results shown in this test report refer only to the sample(s) tested unless otherwise stated.

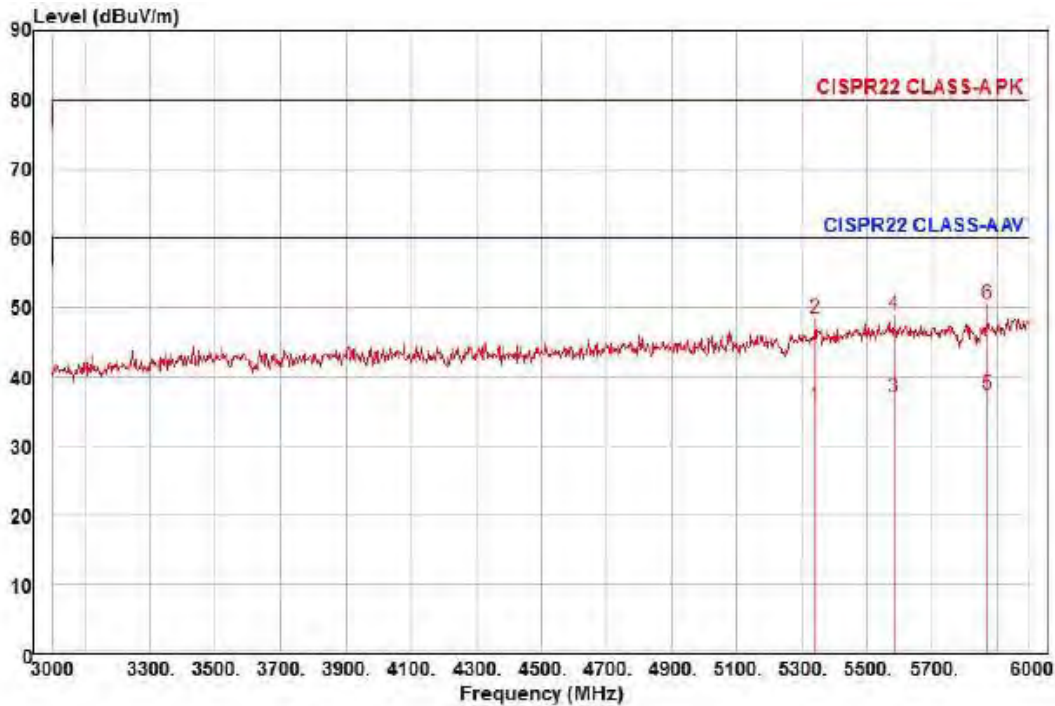

Site : YEOJU\_C 3 m SAC  
 Condition: CISPR22 CLASS-A PK 3m STLP9149(RRA CAL 2017-05-18) horizontal  
 : RBW:1000.000kHz VBW:1000.000kHz SWT:Auto  
 Project :  
 Model : SPN-10080P  
 Mode :  
 Memo : 3 - 6 GHz

	Freq	Read Level	Ant Factor	Cable Loss	Preamplifier Factor	TPos	Limit Line	Over Limit	Pol/Phase	Remark
	MHz	dBuV	dB/m	dB	dB	deg	dBuV/m	dB		
1	5343.00	20.50	34.75	16.34	35.65	290	60.00	-24.06	horizontal	Average
2	5343.00	32.92	34.75	16.34	35.65	290	80.00	-31.64	horizontal	Peak
3	5583.00	20.49	35.49	16.74	35.66	68	60.00	-22.94	horizontal	Average
4	5583.00	32.40	35.49	16.74	35.66	68	80.00	-31.03	horizontal	Peak
5	5874.00	19.94	35.93	17.27	35.68	32	60.00	-22.54	horizontal	Average
6	5874.00	33.09	35.93	17.27	35.68	32	80.00	-29.39	horizontal	Peak

This report shall not be reproduced except in full, without the written approval of KES Co., Ltd.  
 The results shown in this test report refer only to the sample(s) tested unless otherwise stated.

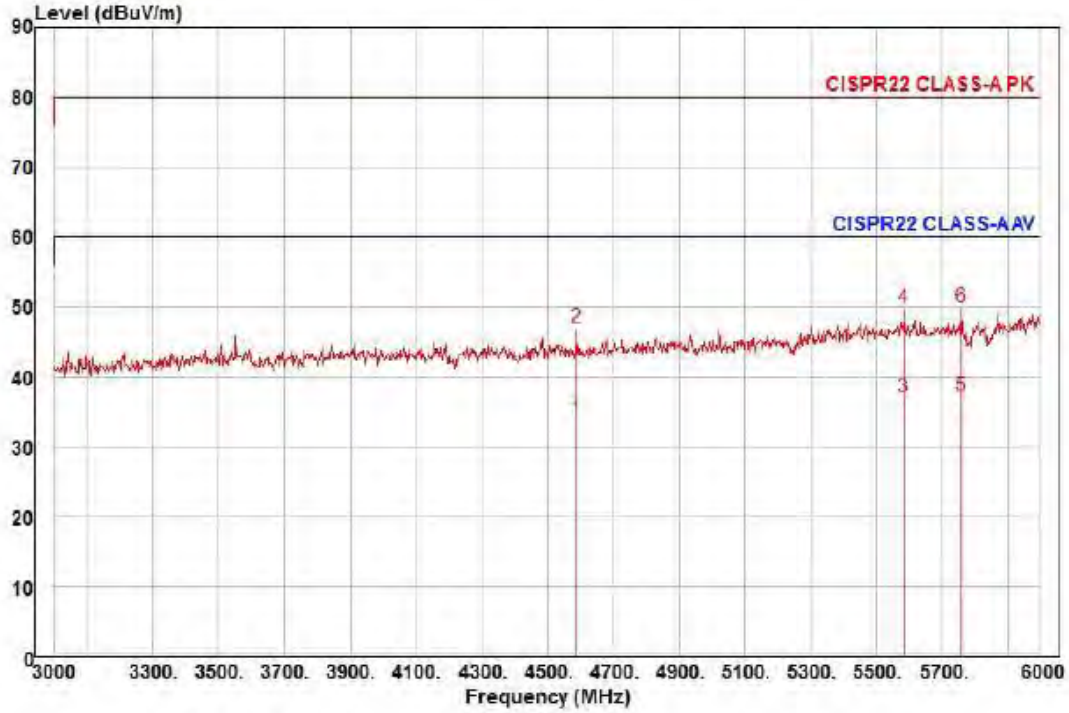

Site : YEOJU\_C 3 m SAC  
 Condition: CISPR22 CLASS-A PK 3m STLP9149(RRA CAL 2017-05-18) vertical  
 : RBW:1000.000kHz VBW:1000.000kHz SWT:Auto  
 Project :  
 Model : SPN-10080P  
 Mode :  
 Memo : 3 - 6 GHz

	Read	Ant	Cable	Preamp	TPos	Limit	Over			
Freq	Level	Factor	Loss	Factor		Line	Limit	Pol/Phase	Remark	
MHz	dBuV	dB/m	dB	dB	deg	dBuV/m	dB			
1	4590.00	21.73	32.55	15.11	35.49	19	60.00	-26.10	vertical	Average
2	4590.00	34.87	32.55	15.11	35.49	19	80.00	-32.96	vertical	Peak
3	5586.00	20.49	35.50	16.74	35.67	159	60.00	-22.94	vertical	Average
4	5586.00	33.31	35.50	16.74	35.67	159	80.00	-30.12	vertical	Peak
5 pp	5760.00	20.14	35.76	16.99	35.68	57	60.00	-22.79	vertical	Average
6 pk	5760.00	33.01	35.76	16.99	35.68	57	80.00	-29.92	vertical	Peak

◆ Calculation

$$\text{Over Limit [dB]} = (\text{Read Level [dB}\mu\text{V]} + \text{Ant Factor [dB/m]} + \text{Cable Loss [dB]} - \text{Preamp Factor [dB]}) - \text{Limit Line [dB}\mu\text{V]}$$

Over Limit : Margin, Read Level : Reading value, Ant Factor : ANT Factor,  
 Cable Loss : Cable loss, Preamp Factor : Preamp Factor

This report shall not be reproduced except in full, without the written approval of KES Co., Ltd.  
 The results shown in this test report refer only to the sample(s) tested unless otherwise stated.



**KES Co., Ltd.**

C-3701, Simin-daero 365-40,  
Dongan-gu, Anyang-si, Gyeonggi-do, 14057, Korea  
Tel: +82-31-425-6200 / Fax: +82-31-424-0450  
www.kes.co.kr

Test report No.:  
KES-E1-17T0644  
Page (28) of (37)

---

## Test Setup Photos and Configuration

### Conducted Voltage Emissions

N/A

N/A

---

This report shall not be reproduced except in full, without the written approval of KES Co., Ltd.  
The results shown in this test report refer only to the sample(s) tested unless otherwise stated.



## Conducted Telecommunication Emissions

- LAN Mode



This report shall not be reproduced except in full, without the written approval of KES Co., Ltd.  
The results shown in this test report refer only to the sample(s) tested unless otherwise stated.

- PoE Mode



This report shall not be reproduced except in full, without the written approval of KES Co., Ltd.  
The results shown in this test report refer only to the sample(s) tested unless otherwise stated.



## Radiated Electric Field Emissions(Below 1 GHz)



This report shall not be reproduced except in full, without the written approval of KES Co., Ltd.  
The results shown in this test report refer only to the sample(s) tested unless otherwise stated.

## Radiated Electric Field Emissions(Above 1 GHz)



This report shall not be reproduced except in full, without the written approval of KES Co., Ltd.  
The results shown in this test report refer only to the sample(s) tested unless otherwise stated.



## EUT External Photographs

(Top)



(Bottom)



This report shall not be reproduced except in full, without the written approval of KES Co., Ltd.  
The results shown in this test report refer only to the sample(s) tested unless otherwise stated.

## EUT Internal Photographs

(Internal View)

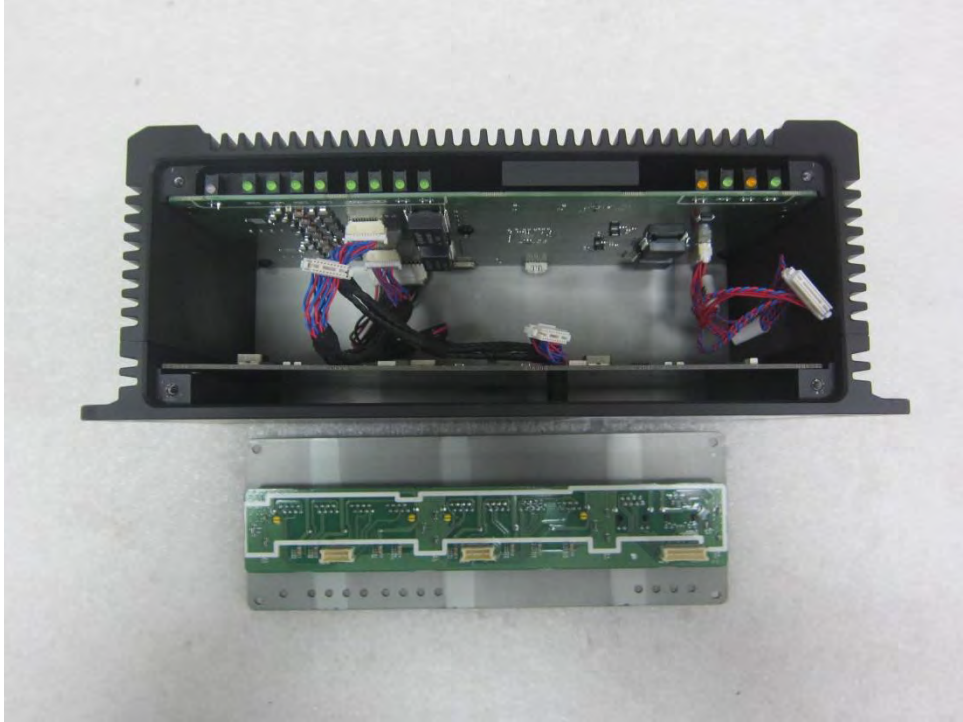

This report shall not be reproduced except in full, without the written approval of KES Co., Ltd.  
The results shown in this test report refer only to the sample(s) tested unless otherwise stated.

## EUT Internal View – Main Board

(Top)

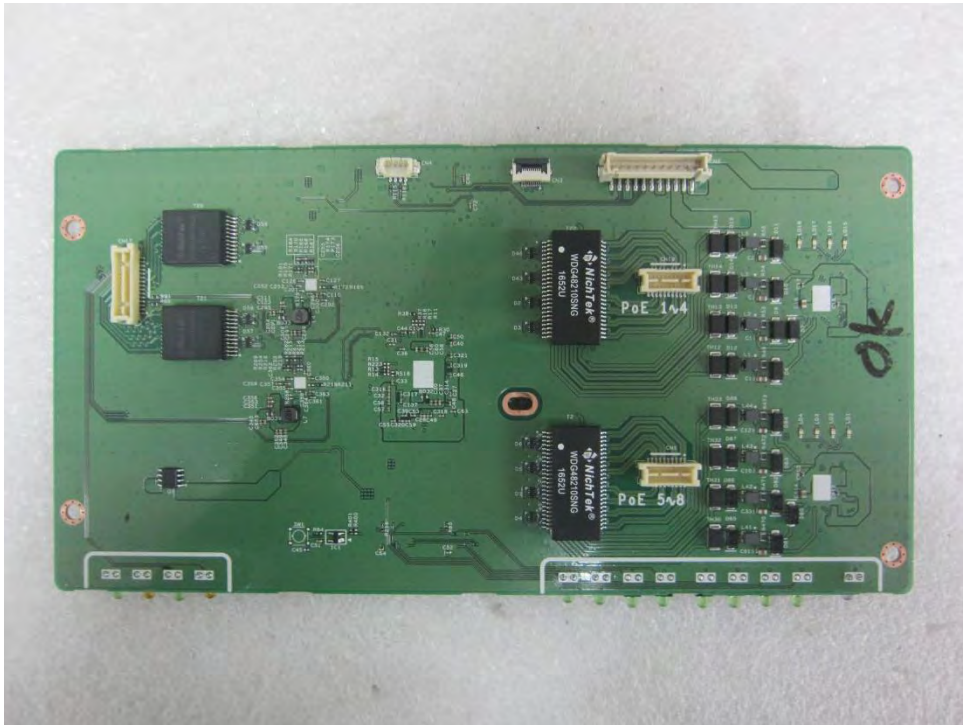

(Bottom)

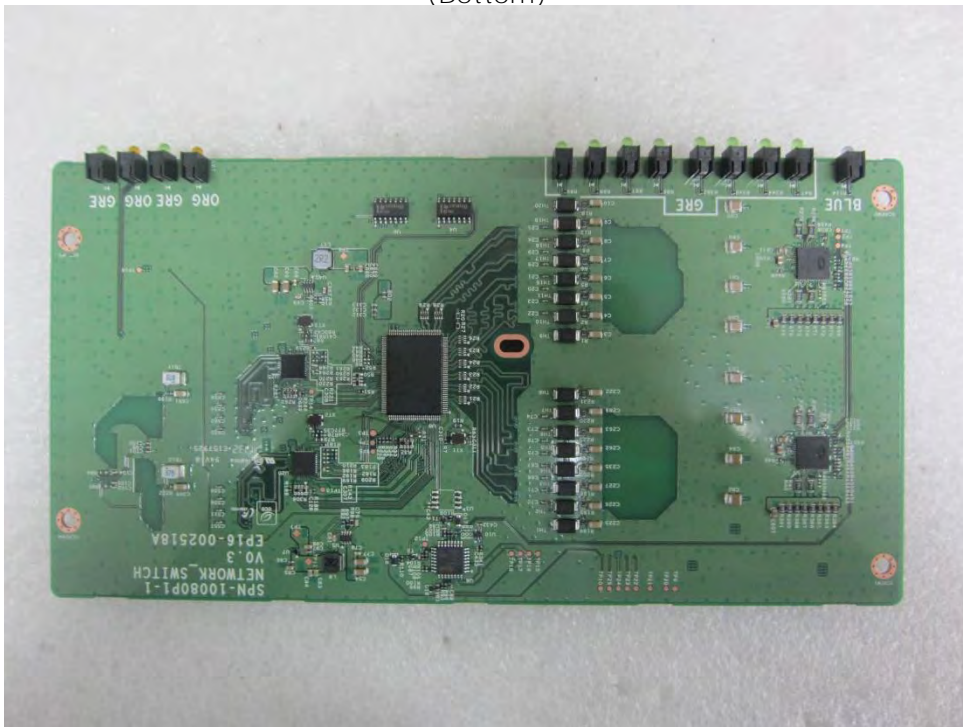

This report shall not be reproduced except in full, without the written approval of KES Co., Ltd.  
The results shown in this test report refer only to the sample(s) tested unless otherwise stated.



## EUT Internal View – Power Board

(Top)

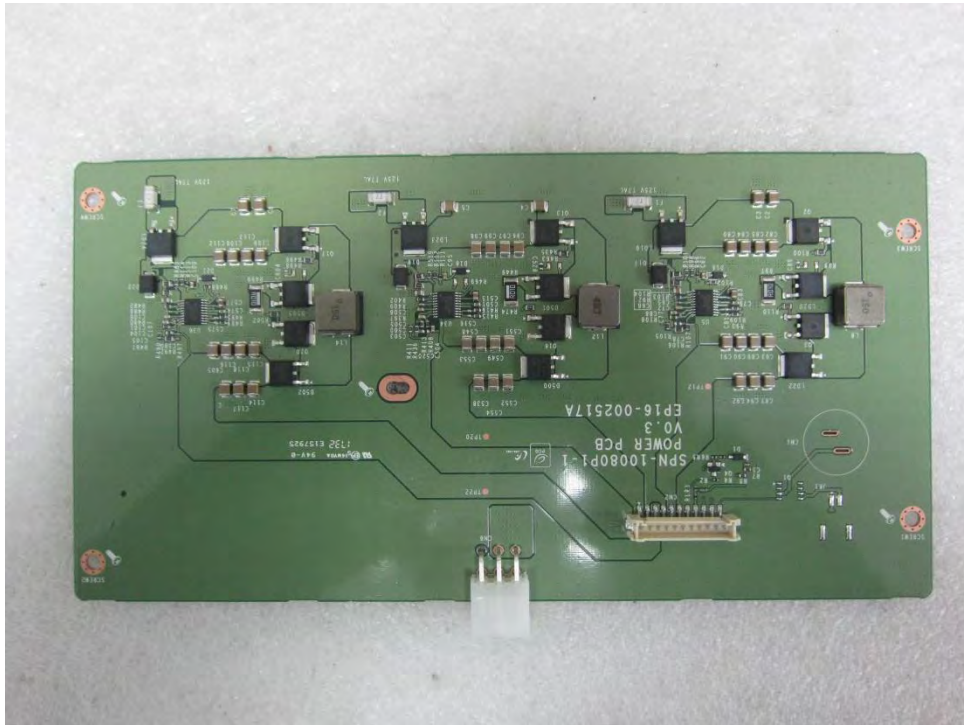

(Bottom)

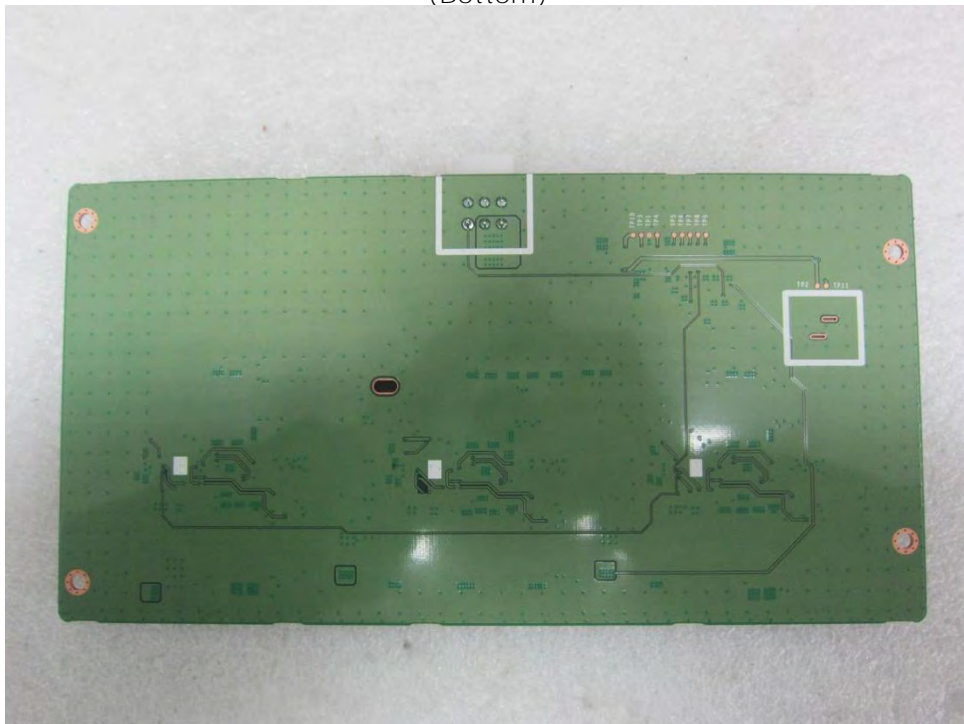

This report shall not be reproduced except in full, without the written approval of KES Co., Ltd.  
The results shown in this test report refer only to the sample(s) tested unless otherwise stated.

## EUT Internal View – Slot Board

(Top)

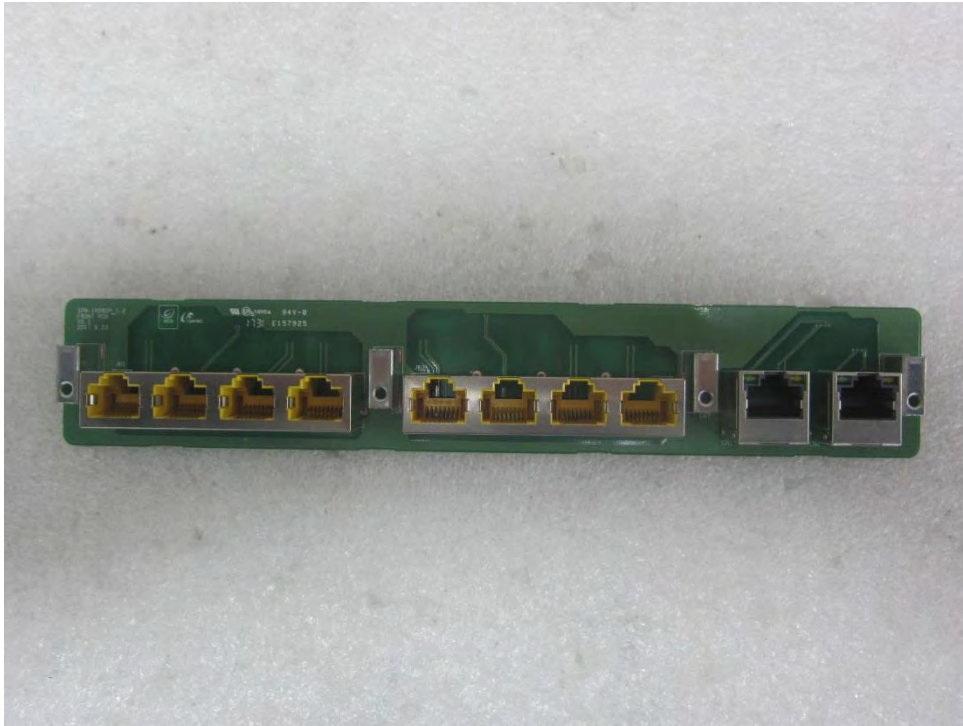

(Bottom)

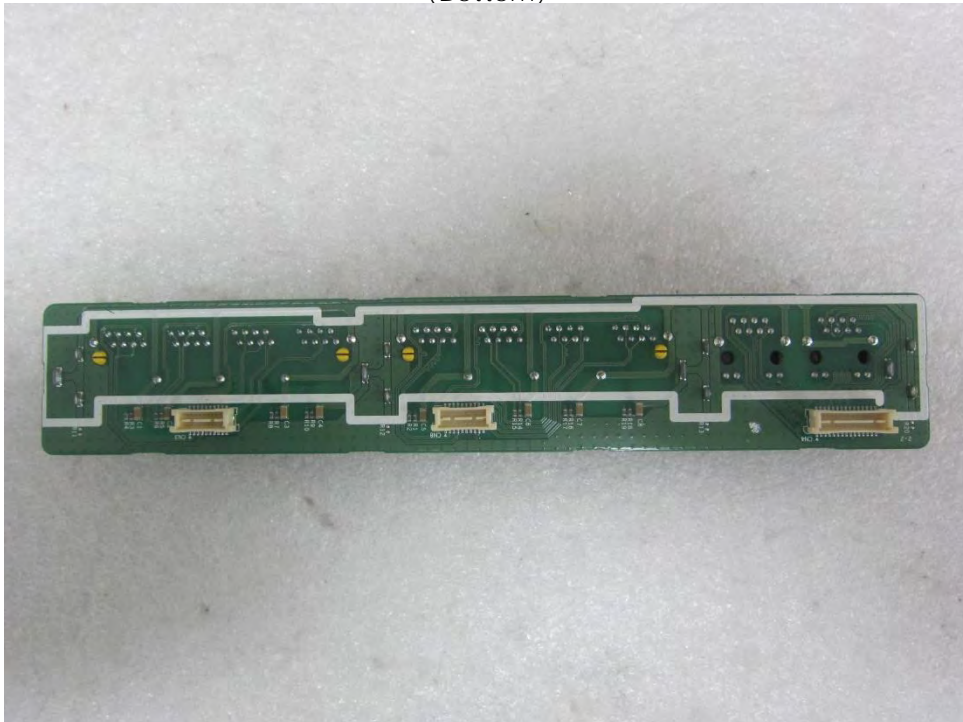

This report shall not be reproduced except in full, without the written approval of KES Co., Ltd.  
The results shown in this test report refer only to the sample(s) tested unless otherwise stated.