

EMC TEST REPORT For FCC

Test Report No. : KES-E1-17T0648
Date of Issue : Sep. 21, 2017
Product name : PoE Switch
Model/Type No. : SPN-10080PM
Variant Model : -
Applicant : Hanwha Techwin Co., Ltd.
Applicant Address : 1204, Changwon-daero, Seongsan-gu Changwon-si,
Gyeongsangnam-do, Korea
Manufacturer : Hanwha Techwin (Tianjin) Co.,Ltd.
Manufacturer Address : No.11 Weiliu Rd, Micro-Electronic Industrial
Park, TEDA, Tianjin, 300385, People's Republic of China
Equipment authorization : Declaration of Conformity
 Verification
 Certification
Date of Receipt : Sep. 06, 2017
Test date : Sep. 16, 2017
Test Results : In Compliance Not in Compliance

Tested by



Young Jun, Jo
EMC Test Engineer

Reviewed by



Dong-Hun, Jang
EMC Technical Manager

This test report is not related to KOLAS.



KES Co., Ltd.

C-3701, Simin-daero 365-40,
Dongan-gu, Anyang-si, Gyeonggi-do, 14057, Korea
Tel: +82-31-425-6200 / Fax: +82-31-424-0450
www.kes.co.kr

Test report No.:
KES-E1-17T0648
Page (2) of (25)

REPORT REVISION HISTORY

Date	Test Report No.	Revision History
Sep. 21, 2017	KES-E1-17T0648	Issued

This report shall not be reproduced except in full, without the written approval of KES Co., Ltd. This document Jul be altered or revised by KES Co., Ltd. personnel only, and shall be noted in the revision section of the document. Any alteration of this document not carried out by KES Co., Ltd. will constitute fraud and shall nullify the document.

This report shall not be reproduced except in full, without the written approval of KES Co., Ltd.
The results shown in this test report refer only to the sample(s) tested unless otherwise stated.



TABLE OF CONTENTS

1.0	General Product Description.....	4
1.1	Test Voltage & Frequency	5
1.2	Variant Model Differences	5
1.3	Device Modifications	5
1.4	Equipment Under Test.....	5
1.5	Support Equipments	5
1.6	External I/O Cabling	6
1.7	EUT Operating Mode(s)	6
1.8	Configuration.....	7
1.9	Remarks when standards applied	8
1.10	Calibration Details of Equipment Used for Measurement	8
1.11	Test Facility	8
1.12	Laboratory Accreditations and Listings	8
2.0	Test Regulations.....	9
2.1	Conducted Emissions at Mains Power Ports	11
2.2	Radiated Electric Field Emissions(Below 1 GHz)	12
2.3	Radiated Electric Field Emissions(Above 1 GHz)	13
APPENDIX A – TEST DATA.....		14
Conducted Emissions at Mains Power Ports.....		14
Radiated Electric Field Emissions(Below 1 GHz)		16
Radiated Electric Field Emissions(Above 1 GHz)		17
Test Setup Photos and Configuration		18
Conducted Voltage Emissions		18
Radiated Electric Field Emissions(Below 1 GHz)		19
Radiated Electric Field Emissions(Above 1 GHz).....		20
EUT External Photographs.....		21
EUT Internal Photographs		22

This report shall not be reproduced except in full, without the written approval of KES Co., Ltd.
The results shown in this test report refer only to the sample(s) tested unless otherwise stated.



1.0 General Product Description

Main Specifications of EUT are:

PoE	
Maximum PoE Budget	64W
PoE Standard	IEEE 802.3af / 802.3at
PoE/PoE+ Ports	Port 1 ~ 8 : PoE/PoE+
Compatible Devices	
Network CCTV Devices	WiseNet Network Cameras, TRM NVR Series
Interface	
1000Base-T Interface	2 (M12, A-Code, 8P Female)
100Base-T PoE Interface	8 (M12, D-Code, 4P Female)
MDI/MDIX adjustable	Yes
Power Input	Molex 6P -> 6P Gender Included
Indicator	
LED	Power Status : 1 -> 0 Ethernet : Link 10-> 2, ACT 10 ->2 PoE Status : 8 -> PoE Link: 8
General	
Dimension (W x D x H)	270 x 134 x 93mm
Weight	TBD
Operation Temperature	-40 ~ 70°C
Operation/Storage Humidity	0% - 95% RH
Maximum Power Consumption	TBD
Power Input	9 ~ 36 VDC (Fanless)
Color/Material	Black / Al
Imgression	X

This report shall not be reproduced except in full, without the written approval of KES Co., Ltd.
The results shown in this test report refer only to the sample(s) tested unless otherwise stated.



1.1 Test Voltage & Frequency

Unless indicated otherwise on the individual data sheet or test results, the test voltage and frequency was as indicated below.

Voltage 230 Vac 120 Vac 24 Vac 12 Vdc PoE
Frequency 50 Hz 60 Hz Hz

1.2 Variant Model Differences

Not applicable

1.3 Device Modifications

Not applicable

1.4 Equipment Under Test

Description	Model Number	Serial Number	Manufacturer	Remarks
PoE Switch	SPN-10080PM	-	Hanwha Techwin (Tianjin) Co.,Ltd.	E.U.T

1.5 Support Equipments

Description	Model Number	Serial Number	Manufacturer	Remarks
Notebook	NT63025J	JK9091EF400432X	SAMSUNG Electronics Co., Ltd.	-
Notebook AC/DC adapter	A13-040N2A	-	Chicony Power Technbology Co., Ltd.	-
PoE Camera 1	-	-	SAMSUNG	-
PoE Camera 2	RS-CH292H3C-36P-ST	-	SAMSUNG	7 EA

This report shall not be reproduced except in full, without the written approval of KES Co., Ltd.
The results shown in this test report refer only to the sample(s) tested unless otherwise stated.

1.6 External I/O Cabling

Start		END		Cable Spec.	
Description	I/O Port	Description	I/O Port	Length	Shield
PoE Switch (E.U.T)	RJ-45	Notebook	RJ-45	3.5	S
	RJ-45	PoE Camera 1	RJ-45	3.5	S
	RJ-45	PoE Camera 2	RJ-45	5.0	S
	RJ-45	PoE Camera 2	RJ-45	5.0	S
	RJ-45	PoE Camera 2	RJ-45	5.0	S
	RJ-45	PoE Camera 2	RJ-45	5.0	S
	RJ-45	PoE Camera 2	RJ-45	5.0	S
	RJ-45	PoE Camera 2	RJ-45	5.0	S
	RJ-45	PoE Camera 2	RJ-45	5.0	S

* Unshielded=U, Shielded=S

1.7 EUT Operating Mode(s)

Test mode	operating
Normal Operating	Check the video output of the camera & Ping test

E.U.T Test operating S/W		
Name	Version	Manufacture Company
-	-	-

This report shall not be reproduced except in full, without the written approval of KES Co., Ltd.
 The results shown in this test report refer only to the sample(s) tested unless otherwise stated.

1.8 Configuration

■ AC Main
□ DC Main

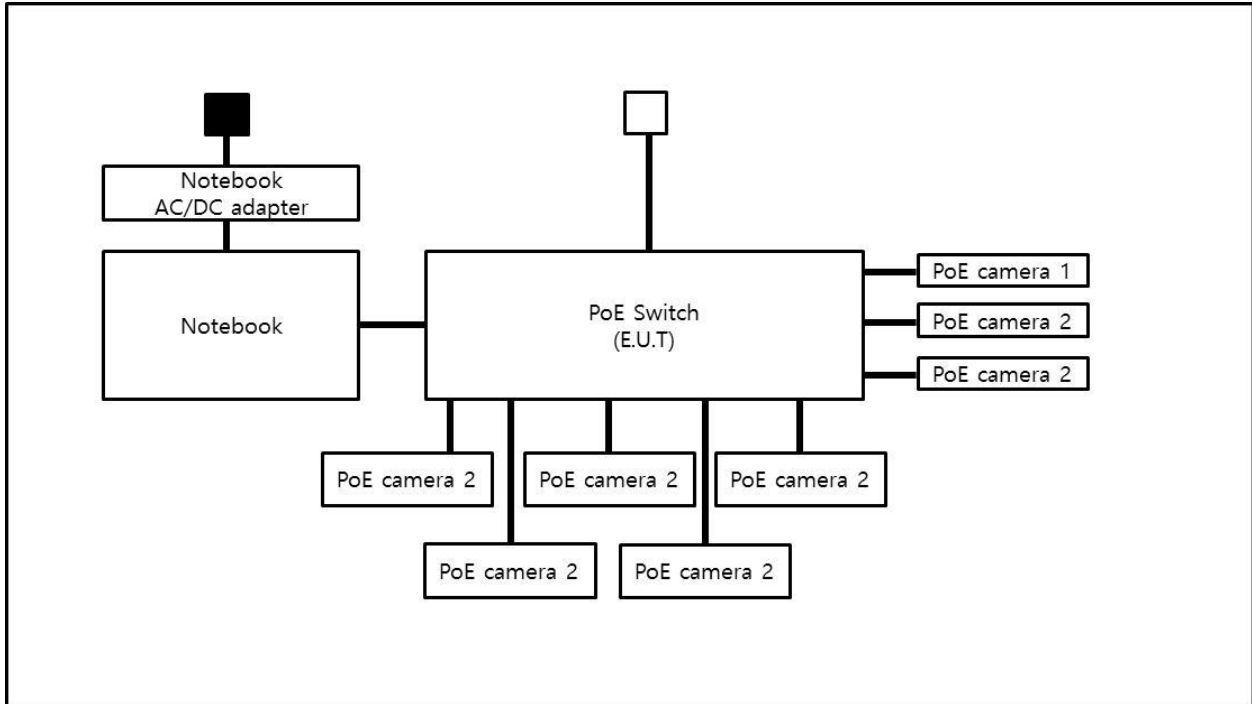

This report shall not be reproduced except in full, without the written approval of KES Co., Ltd.
The results shown in this test report refer only to the sample(s) tested unless otherwise stated.

1.9 Remarks when standards applied

N/A







1.10 Calibration Details of Equipment Used for Measurement

Test equipment and test accessories are calibrated on regular basis. The maximum time between calibrations is one year or what is recommended by the manufacturer, whichever is less.

1.11 Test Facility

The measurement facility is located at 473-21 Gayeo-ro, Yeosu-si, Gyeonggi-do, 12658, Korea. The sites are constructed in conformance with the requirements of ANSI C63.4 and CISPR Publication 22.

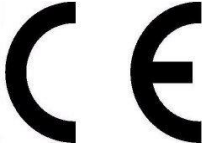
1.12 Laboratory Accreditations and Listings

Country	Agency	Scope of Accreditation	Logo
USA	FCC	3 & 10 meter Open Area Test Sites and one conducted site to perform FCC Part 15/18 measurements.	
JAPAN	VCCI	Mains Ports Conducted Interference Measurement, Telecommunication Ports Conducted Disturbance Measurement and Radiation 10 meter site, Facility for measuring radiated disturbance above 1 GHz	 R-4308, C-4798, T-2311, G-914
KOREA	MSIP	EMI (10 meter Open Area Test Site and two conducted sites) Radio(3 & 10 meter Open Area Test Sites and one conducted site) EMS (ESD, RS, EFT/Burst, Surge, CS, Magnetic, Dips and interruptions)	 KR0100
Canada	IC	3 & 10 meter Open Area Test Sites and one conducted site	 4769B-1
Europe	CE	EMI (10 meter Open Area Test Site and two conducted sites) Radio(3 & 10 meter Open Area Test Sites and one conducted site) EMS (ESD, RS, EFT/Burst, Surge, CS, Magnetic, Dips and interruptions)	
International	KOLAS	EMI (10 meter Open Area Test Site and two conducted sites) Radio(3 & 10 meter Open Area Test Sites and one conducted site) EMS (ESD, RS, EFT/Burst, Surge, CS, Magnetic, Dips and interruptions)	

This report shall not be reproduced except in full, without the written approval of KES Co., Ltd.
 The results shown in this test report refer only to the sample(s) tested unless otherwise stated.

2.0 Test Regulations

The emissions tests were performed according to following regulations:

EMC – Directive 2014/30/EU

EN 61000-6-3:2011

EN 61000-6-1:2007

EN 61000-6-4:2007 +A1:2011

EN 61000-6-2:2005

EN 55011:2007 +A1:2010

Group 1
 Class A

Group 2
 Class B

EN 55014-1:2006 +A2:2011

EN 55014-2:1997 +A2:2008

EN 55015:2013

EN 55032:2015

Class A

Class B

EN 55024:2010

EN 50130-4:2011 +A1:2014

EN 61000-3-2:2014

EN 61000-3-3:2013

EN 61326-1:2013



-
- | | | |
|---|---|----------------------------------|
| <input type="checkbox"/> VCCI V-3 / 2015.04 | <input type="checkbox"/> Class A | <input type="checkbox"/> Class B |
| <input type="checkbox"/> AS/NZS:2013 | <input type="checkbox"/> Class A | <input type="checkbox"/> Class B |
| <input checked="" type="checkbox"/> 47 CFR Part 15, Subpart B | | |
| <input checked="" type="checkbox"/> CISPR 22:2009 +A1:2010
(Below 1 GHz) | <input checked="" type="checkbox"/> Class A | <input type="checkbox"/> Class B |
| <input checked="" type="checkbox"/> ANSI C63.4-2014
(Above 1 GHz) | <input checked="" type="checkbox"/> Class A | <input type="checkbox"/> Class B |
| <input type="checkbox"/> IC Regulation ICES-003 : 2016 | | |
| <input type="checkbox"/> CAN/CSA CISPR 22-10 | <input type="checkbox"/> Class A | <input type="checkbox"/> Class B |
| <input type="checkbox"/> ANSI C63.4-2014 | | |
| <input type="checkbox"/> RE- Directive 2014/53/EU | | |
| <input type="checkbox"/> EN 301 489-1 V1.9.2 | | |
| <input type="checkbox"/> Equipment for fixed use | | |
| <input type="checkbox"/> Equipment for vehicular use | | |
| <input type="checkbox"/> Equipment for portable use | | |
| <input type="checkbox"/> EN 301 489-3 V1.6.1 | | |
| <input type="checkbox"/> EN 301 489-17 V2.2.1 | | |
| <input type="checkbox"/> EN 60945:2002 | | |

This report shall not be reproduced except in full, without the written approval of KES Co., Ltd.
The results shown in this test report refer only to the sample(s) tested unless otherwise stated.



2.1 Conducted Emissions at Mains Power Ports

Test Date

N/A

Test Location

Electro wave Shieldroom

Test Equipment

Used	Description	Model Number	Manufacturer	Serial Number	Cal. Due
<input type="checkbox"/>	EMI Test S/W	EMC32	R & S	9.12.00	-
<input type="checkbox"/>	EMI TEST RECEIVER	ESR3	R & S	101783	04, 27, 2018
<input type="checkbox"/>	LISN	ENV216	R & S	101137	02, 03, 2018
<input type="checkbox"/>	LISN	ENV216	R & S	101786	04, 27, 2018
<input type="checkbox"/>	PULSE LIMITER	ESH3-Z2	R & S	101914	12, 13, 2017

Test Conditions

Temperature: °C
Relative Humidity: %

Frequency Range of Measurement

150 kHz to 30 MHz

Instrument Settings

IF Band Width: 9 kHz

Test Results

The requirements are:

- PASS
- NOT PASS
- NOT APPLICABLE

Remarks

N/A

2.2 Radiated Electric Field Emissions(Below 1 GHz)

Test Date

Sep. 16, 2017

Test Location OPEN AREA TEST SITE #2 SAC #4(10 m)**Test Equipment**

Used	Description	Model Number	Manufacturer	Serial Number	Cal. Due
<input checked="" type="checkbox"/>	EMI Test S/W	EP5/RE	TOYO Corporation	6.0.0	-
<input checked="" type="checkbox"/>	EMI TEST RECEIVER	ESU26	R & S	100551	04, 18, 2018
<input checked="" type="checkbox"/>	AMPLIFIER	SCU 01	R & S	100603	12, 13, 2017
<input checked="" type="checkbox"/>	TRILOG-BROADBAND ANTENNA	VULB9163	Schwarzbeck	716	11, 28, 2018

Test Conditions

Temperature: 23,6 °C

Relative Humidity: 52,3 %

Frequency Range of Measurement

30 MHz to 1 GHz

Instrument Settings

IF Band Width: 120 kHz

Test Results

The requirements are:

- PASS
 NOT PASS
 NOT APPLICABLE

RemarksSee Appendix A for test data.

2.3 Radiated Electric Field Emissions(Above 1 GHz)

Test Date

Sep. 16, 2017

Test Location

SAC #4(10 m)

Test Equipment

Used	Description	Model Number	Manufacturer	Serial Number	Cal. Due
<input checked="" type="checkbox"/>	EMI Test S/W	EP5/RE	TOYO Corporation	6.0.0	-
<input checked="" type="checkbox"/>	EMI TEST RECEIVER	ESU26	R & S	100551	04, 17, 2018
<input checked="" type="checkbox"/>	PREAMPLIFIER	8449B	AGILENT	3008A01967	05, 31, 2017
<input type="checkbox"/>	ATTENUATOR	8491A	HP	32173	03, 24, 2018
<input checked="" type="checkbox"/>	DOUBLE RIDGED HORN ANTENNA	SAS-571	A.H.SYSTEM,INC	781	05, 02, 2019

Test Conditions

Temperature: 23,6 °C

Relative Humidity: 52,3 %

Frequency Range of Measurement

1 GHz to 5 GHz

Instrument Settings

IF Band Width: 1 MHz

Test Results

The requirements are:

- PASS
 NOT PASS
 NOT APPLICABLE

RemarksSee Appendix A for test data.



KES Co., Ltd.

C-3701, Simin-daero 365-40,
Dongan-gu, Anyang-si, Gyeonggi-do, 14057, Korea
Tel: +82-31-425-6200 / Fax: +82-31-424-0450
www.kes.co.kr

Test report No.:
KES-E1-17T0648
Page (14) of (25)

APPENDIX A – TEST DATA

Conducted Emissions at Mains Power Ports

[HOT]

N/A

This report shall not be reproduced except in full, without the written approval of KES Co., Ltd.
The results shown in this test report refer only to the sample(s) tested unless otherwise stated.



KES Co., Ltd.

C-3701, Simin-daero 365-40,
Dongan-gu, Anyang-si, Gyeonggi-do, 14057, Korea
Tel: +82-31-425-6200 / Fax: +82-31-424-0450
www.kes.co.kr

Test report No.:
KES-E1-17T0648
Page (15) of (25)

[NEUTRAL]

N/A

◆ Calculation

QuasiPeak[dBuV] / CAverage [dBuV] = Reading Value[dBuV] + Corr. [dB]

QuasiPeak / CAverage : The Final Value

Reading Value : Not shown in the table.

Corr. : Correction values (LISN FACTOR + (Cable Loss + Pulse Limiter FACTOR))

This report shall not be reproduced except in full, without the written approval of KES Co., Ltd.
The results shown in this test report refer only to the sample(s) tested unless otherwise stated.

Radiated Electric Field Emissions(Below 1 GHz)

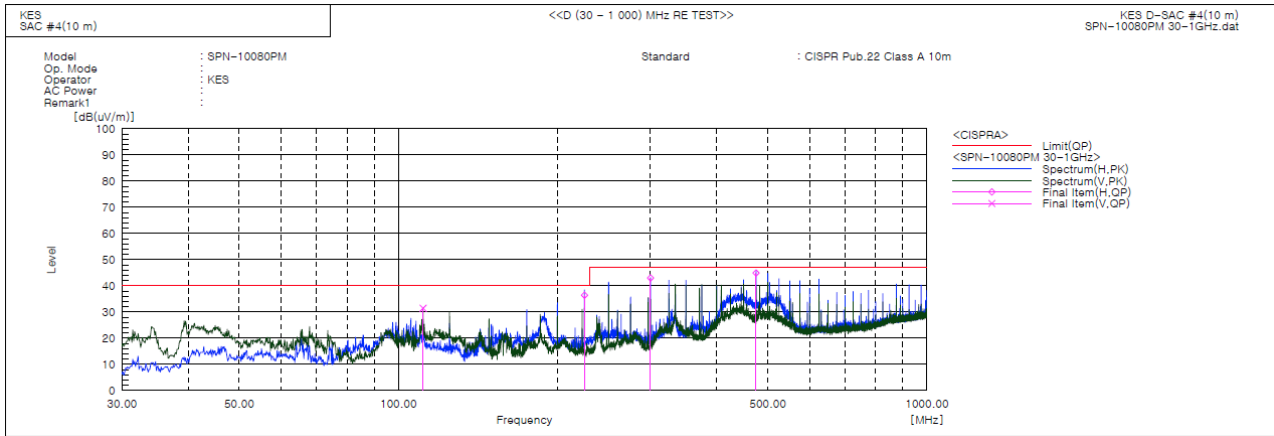

Final Result

No.	Frequency [MHz]	(P)	Reading QP [dB(uV)]	c.f [dB(1/m)]	Result QP [dB(uV/m)]	Limit QP [dB(uV/m)]	Margin QP [dB]	Height [cm]	Angle [deg]	Remark
1	111.375	V	60.9	-29.4	31.5	40.0	8.5	114.0	105.0	
2	225.009	H	62.5	-26.1	36.4	40.0	3.6	386.0	134.0	
3	300.018	H	66.8	-23.8	43.0	47.0	4.0	260.0	260.0	
4	475.031	H	63.2	-18.3	44.9	47.0	2.1	191.0	196.0	

◆ Calculation - SAC #4(10 m)

Result(QP) [dB(μV/m)] = (Reading(QP)[dB(μV)] + c.f[dB(1/m)])

Margin(QP)[dB] = Limit[dB(μV/m)] - Result(QP) [dB(μV/m)]

Reading(QP) : Reading value, Result(QP) : Reading value + Factor value

Limit(QP) : Limit value, c.f : (ANT Factor + Cable Loss - Preamp Factor), Margin: Margin value

Radiated Electric Field Emissions(Above 1 GHz)

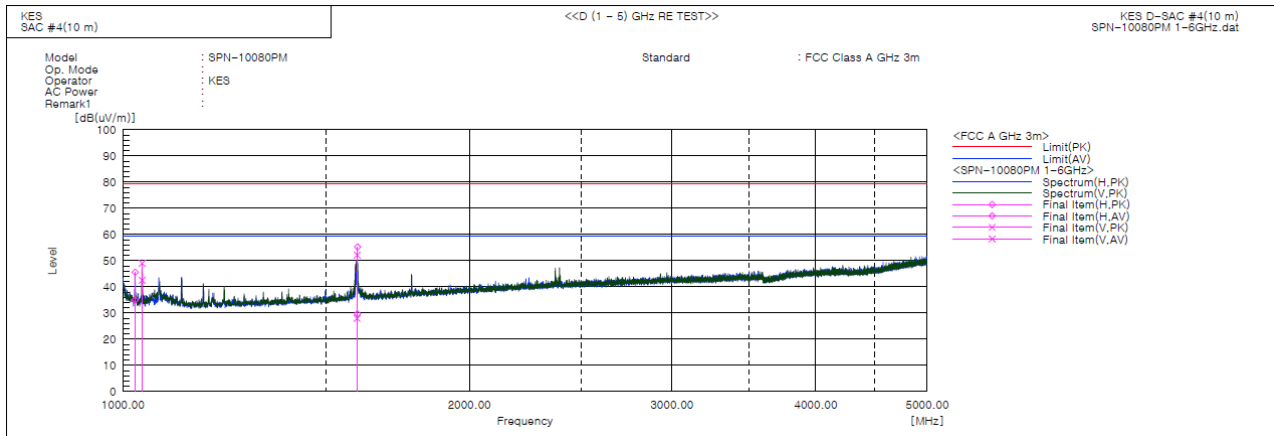

Final Result

No.	Frequency [MHz]	(P)	Reading PK [dB(uV)]	Reading AV [dB(uV)]	c.f [dB(1/m)]	Result PK [dB(uV/m)]	Result AV [dB(uV/m)]	Limit PK [dB(uV/m)]	Limit AV [dB(uV/m)]	Margin PK [dB]	Margin AV [dB]	Height [cm]	Angle [deg]	Remark
1	1024.920	H	52.1	41.5	-6.5	45.6	35.0	79.5	59.5	33.9	24.5	127.0	232.0	
2	1039.515	V	55.4	49.0	-6.4	49.0	42.6	79.5	59.5	30.5	16.9	100.0	12.0	
3	1597.890	V	53.4	29.1	-1.2	52.2	27.9	79.5	59.5	27.3	31.6	127.0	19.0	
4	1599.095	H	56.4	31.0	-1.2	55.2	29.8	79.5	59.5	24.3	29.7	141.0	287.0	

◆ Calculation

Result(PK/CAV) [dB(μV/m)] = (Reading(PK/CAV)[dB(μV)] + c.f[dB(1/m)])

Margin(PK/CAV)[dB] = Limit[dB(μV/m)] - Result(PK/CAV) [dB(μV/m)]

Reading(PK/CAV) : Reading value, Result(PK/CAV) : Reading value + Factor value

Limit(QP) : Limit value, c.f : (ANT Factor + Cable Loss - Preamp Factor), Margin: Margin value



KES Co., Ltd.

C-3701, Simin-daero 365-40,
Dongan-gu, Anyang-si, Gyeonggi-do, 14057, Korea
Tel: +82-31-425-6200 / Fax: +82-31-424-0450
www.kes.co.kr

Test report No.:
KES-E1-17T0648
Page (18) of (25)

Test Setup Photos and Configuration

Conducted Voltage Emissions

N/A

N/A

This report shall not be reproduced except in full, without the written approval of KES Co., Ltd.
The results shown in this test report refer only to the sample(s) tested unless otherwise stated.

Radiated Electric Field Emissions(Below 1 GHz)

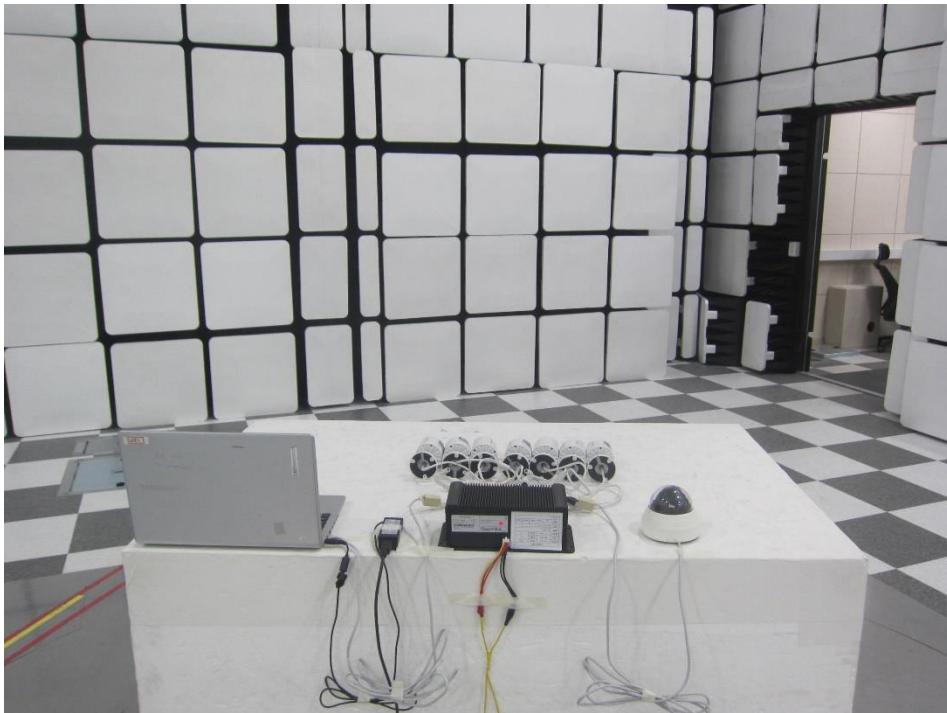
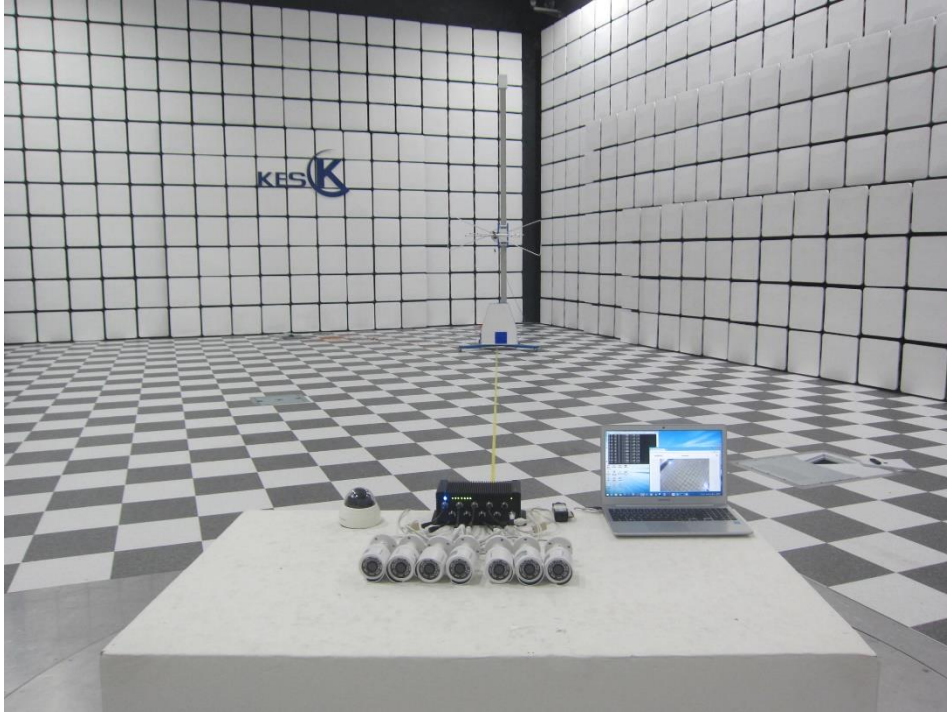

This report shall not be reproduced except in full, without the written approval of KES Co., Ltd.
The results shown in this test report refer only to the sample(s) tested unless otherwise stated.

Radiated Electric Field Emissions(Above 1 GHz)

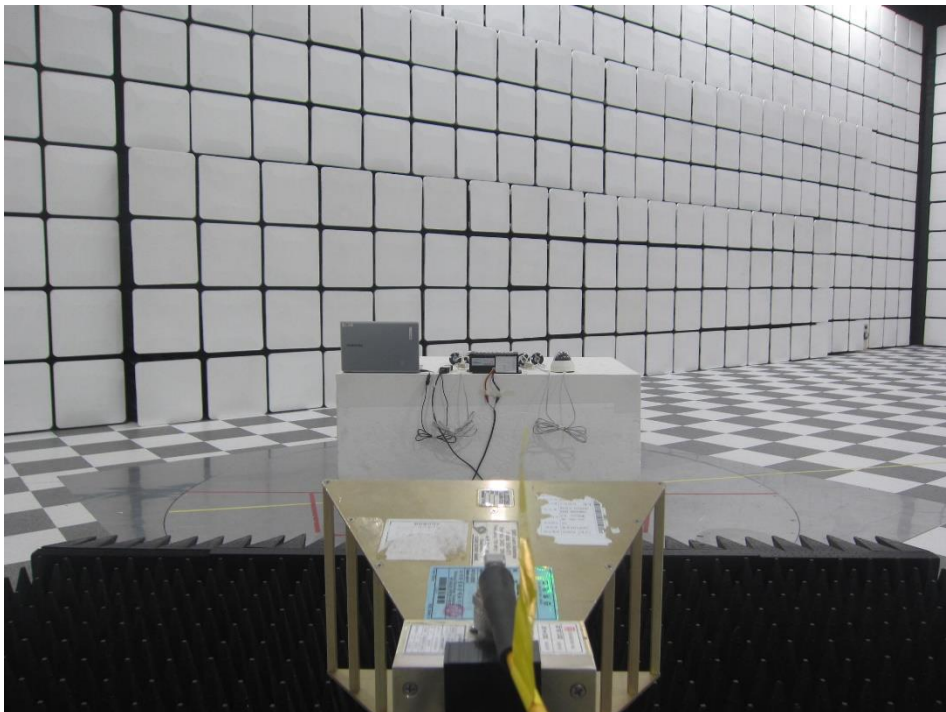
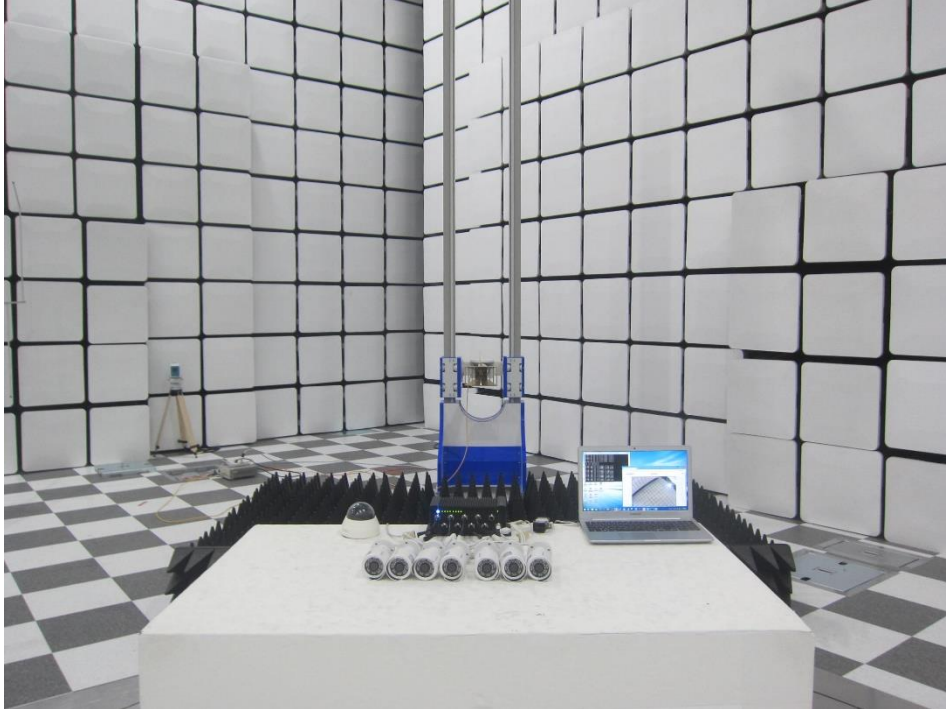

This report shall not be reproduced except in full, without the written approval of KES Co., Ltd.
The results shown in this test report refer only to the sample(s) tested unless otherwise stated.

EUT External Photographs

(Top)



(Bottom)



This report shall not be reproduced except in full, without the written approval of KES Co., Ltd.
The results shown in this test report refer only to the sample(s) tested unless otherwise stated.

EUT Internal Photographs

(Internal View)

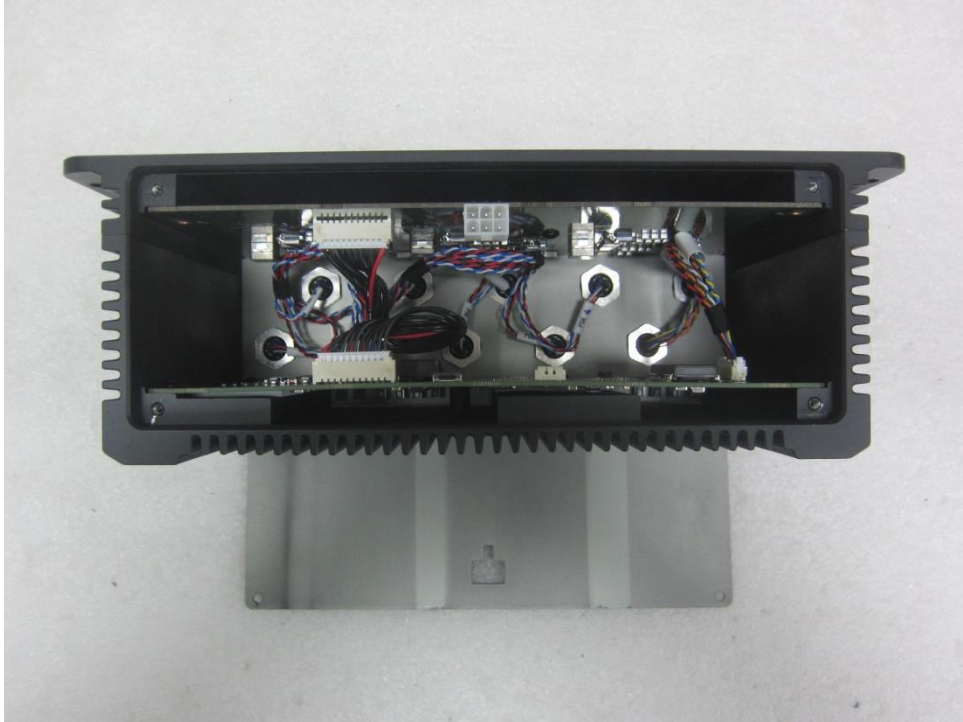

This report shall not be reproduced except in full, without the written approval of KES Co., Ltd.
The results shown in this test report refer only to the sample(s) tested unless otherwise stated.

EUT Internal View – Main Board

(Top)

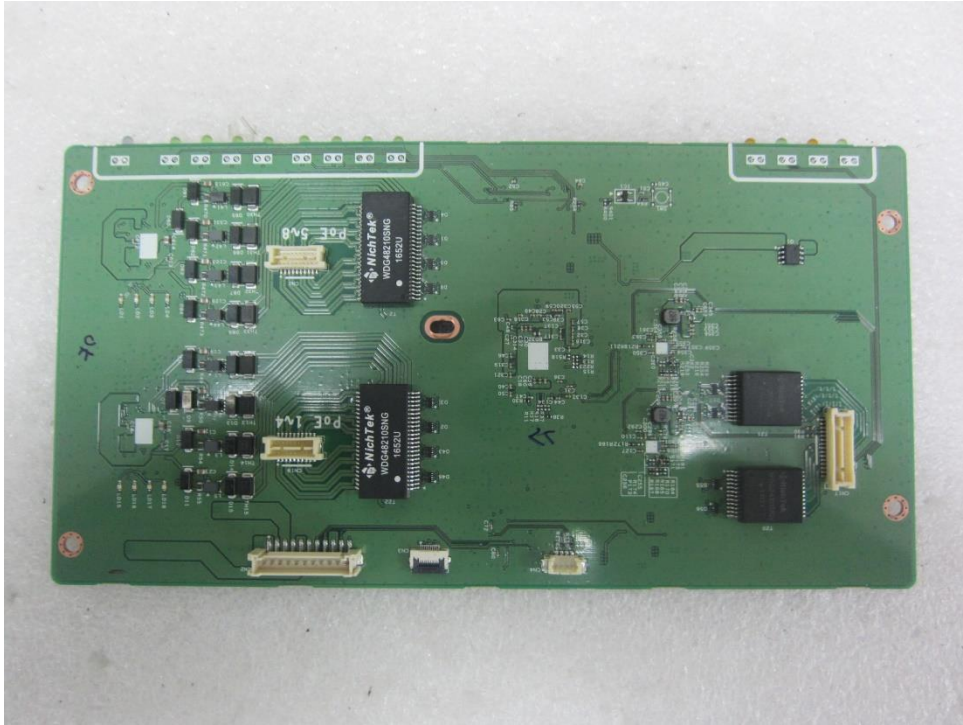

(Bottom)

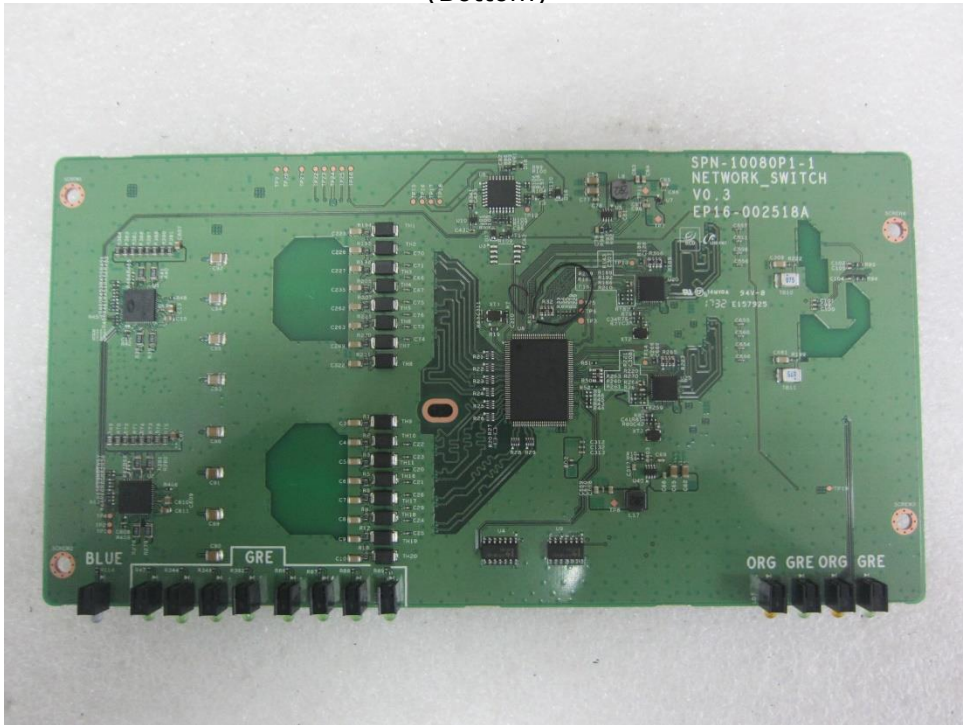

This report shall not be reproduced except in full, without the written approval of KES Co., Ltd.
The results shown in this test report refer only to the sample(s) tested unless otherwise stated.

EUT Internal View – Power Board

(Top)

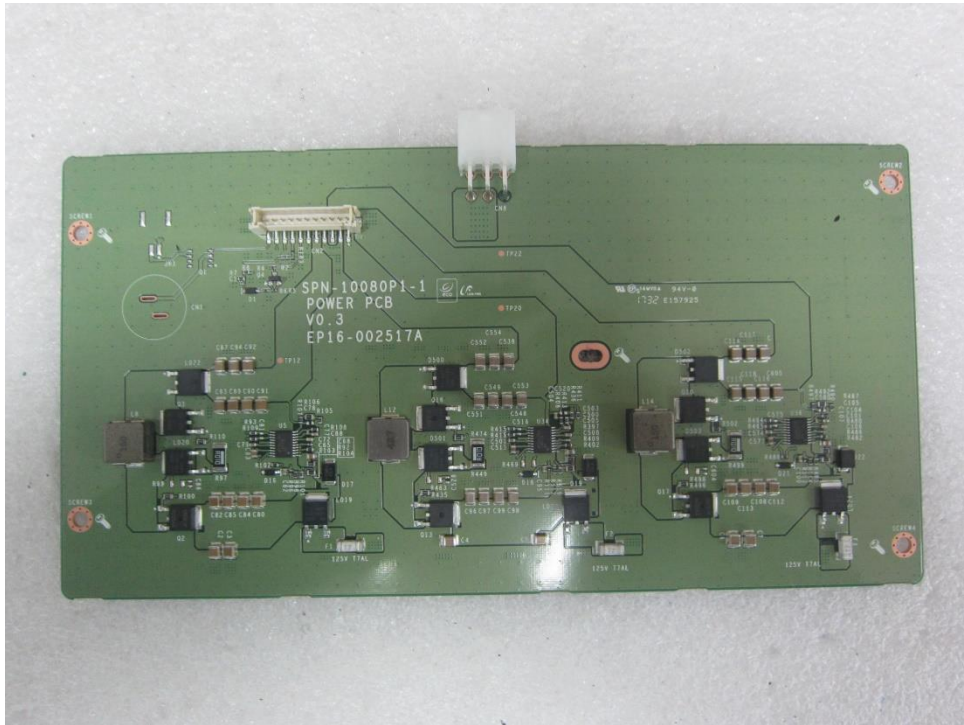

(Bottom)

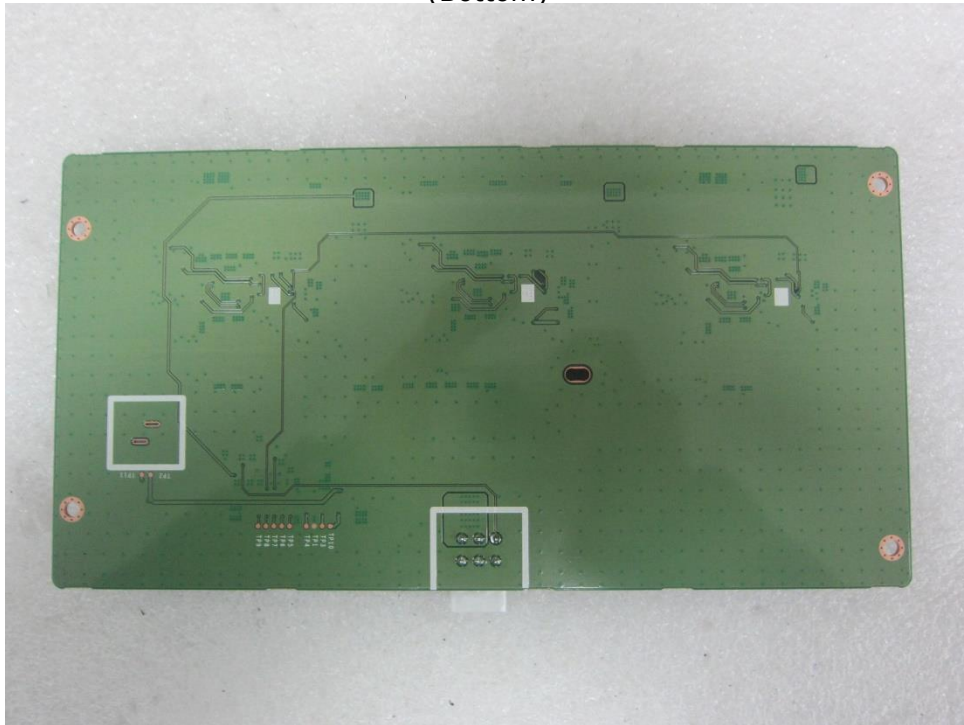

This report shall not be reproduced except in full, without the written approval of KES Co., Ltd.
The results shown in this test report refer only to the sample(s) tested unless otherwise stated.

Label Photographs

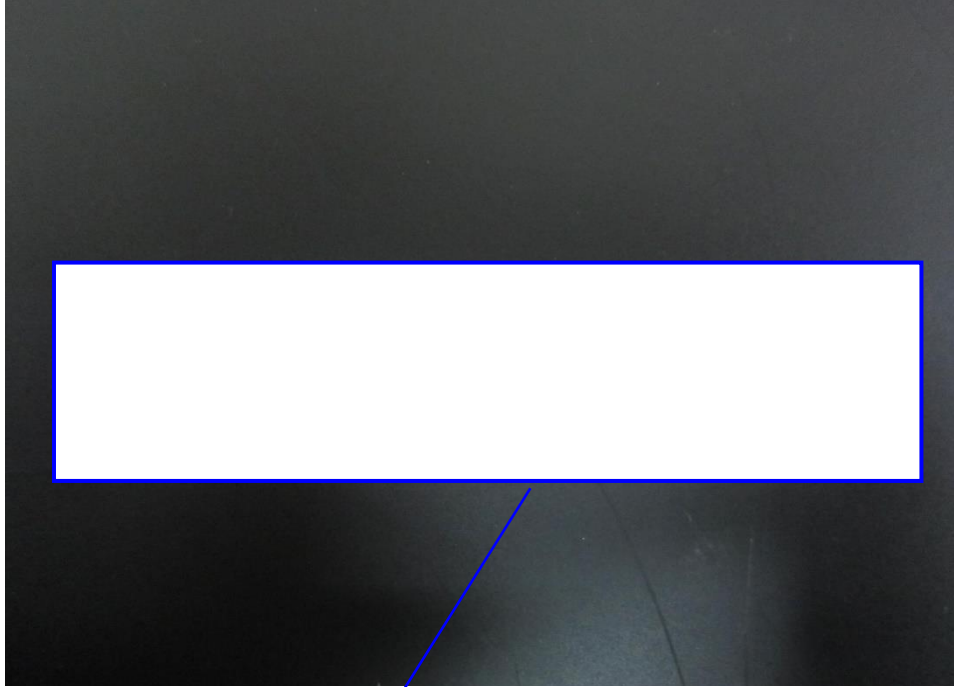

This device complies with part 15 of the FCC Rules. Operation in subject to the following two conditions: (1) This device Sep not cause harmful interference, and (2) this device must accept any interference received, including interference that Sep cause undesired operation.