

WISENET

NETWORK VIDEO DECODER

User Manual

SPD-150

CE

Network Video Decoder

User Manual

Copyright

©2017 Hanwha Techwin Co., Ltd. All rights reserved.

Trademark

Each of trademarks herein is registered. The name of this product and other trademarks mentioned in this manual are the registered trademark of their respective company.

Restriction

Copyright of this document is reserved. Under no circumstances, this document shall be reproduced, distributed or changed, partially or wholly, without formal authorization.

Disclaimer

Hanwha Techwin makes the best to verify the integrity and correctness of the contents in this document, but no formal guarantee shall be provided. Use of this document and the subsequent results shall be entirely on the user's own responsibility. Hanwha Techwin reserves the right to change the contents of this document without prior notice.

❖ Design and specifications are subject to change without prior notice.

❖ The initial administrator ID is “admin” and the password should be set when logging in for the first time.
Please change your password every three months to safely protect personal information and to prevent the damage of the information theft.
Please, take note that it's a user's responsibility for the security and any other problems caused by mismanaging a password.

IMPORTANT SAFETY INSTRUCTIONS

Read these operating instructions carefully before using the unit.
Follow all the safety instructions listed below.
Keep these operating instructions handy for future reference.

- 1) Read these instructions.
- 2) Keep these instructions.
- 3) Heed all warnings.
- 4) Follow all instructions.
- 5) Do not use this apparatus near water.
- 6) Clean the contaminated area on the product surface with a soft, dry cloth or a damp cloth. (Do not use a detergent or cosmetic products that contain alcohol, solvents or surfactants or oil constituents as they may deform or cause damage to the product.)
- 7) Do not block any ventilation openings, Install in accordance with the manufacturer's instructions.
- 8) Do not install near any heat sources such as radiators, heat registers, stoves, or other apparatus (including amplifiers) that produce heat.
- 9) Do not defeat the safety purpose of the polarized or grounding- type plug. A polarized plug has two blades with one wider than the other. A grounding type plug has two blades and a third grounding prong. The wide blade or the third prong are provided for your safety. If the provided plug does not fit into your outlet, consult an electrician for replacement of the obsolete outlet.
- 10) Protect the power cord from being walked on or pinched particularly at plugs, convenience receptacles, and the point where they exit from the apparatus.
- 11) Only use attachments/accessories specified by the manufacturer.
- 12) Use only with the cart, stand, tripod, bracket, or table specified by the manufacturer, or sold with the apparatus. When a cart is used, use caution when moving the cart/ apparatus combination to avoid injury from tip-over.
- 13) Unplug this apparatus during lightning storms or when unused for long periods of time.
- 14) Refer all servicing to qualified service personnel. Servicing is required when the apparatus has been damaged in any way, such as power-supply cord or plug is damaged, liquid has been spilled or objects have fallen into the apparatus, the apparatus has been exposed to rain or moisture, does not operate normally, or has been dropped.
- 15) This product is intended to be supplied by Listed Power Unit marked "Class 2" or "LPS" and rated 12 Vdc, Min. 1.8 A.
- 16) The wired LAN hub providing power over the Ethernet (PoE) in accordance with IEEE 802-3af shall be a UL Listed device with the output evaluated as a Limited Power Source as defined in UL60950-1.
- 17) Associated Ethernet wiring shall be limited to inside the building.



Standards Approvals



- ! Any changes or modifications in construction of this device which are not expressly approved by the party responsible for compliance could void the user's authority to operate the equipment.
- ✍ This device complies with part 15 of the FCC Rules. Operation is subject to the following two conditions: (1) This device may not cause harmful interference, and (2) this device must accept any interference received, including interference that may cause undesired operation.
 - This equipment has been tested and found to comply with the limits for a Class A digital device, pursuant to part 15 of the FCC Rules. These limits are designed to provide reasonable protection against harmful interference when the equipment is operated in a commercial environment. This equipment generates, uses, and can radiate radio frequency energy and, if not installed and used in accordance with the instruction manual, may cause harmful interference to radio communications. Operation of this equipment in a residential area is likely to cause harmful interference in which case the user will be required to correct the interference at his own expense.

BEFORE START

This manual provides operational information necessary for using the product and contains a description about each component part and its function as well as menu or network settings.

You have to keep in mind the following notices :

- Hanwha Techwin retains the copyright on this manual.
- This manual cannot be copied without Hanwha Techwin's prior written approval.
- We are not liable for any or all losses to the product incurred by your use of non-standard product or violation of instructions mentioned in this manual.
- Prior to opening the case, please consult a qualified technician first. Whenever this is needed power must be removed from the unit.

Warning

Battery

It is essential that when changing the battery in the unit, the replacement battery must be of the same type otherwise there may be a possibility of an explosion.

The following are the specifications of the battery you are using now.

- Normal voltage : 3V
- Normal capacity : 210mAh
- Continuous standard load : 0.4mA
- Operating temperature : -20°C ~ +60°C
(-4°F ~ +140°F)

CALIFORNIA USA ONLY

This Perchlorate warning applies only to primary CR (Manganese Dioxide) Lithium coin cells in the product sold or distributed ONLY in California USA.
"Perchlorate Material - special handling may apply,
See www.dtsc.ca.gov/hazardouswaste/perchlorate."

Caution

- Connect the power cord into a grounded outlet.
- The Mains plug is used as a disconnect device and shall stay readily operable at any time.
- Batteries shall not be exposed to excessive heat such as sunshine, fire or the like.
- Risk of Explosion if Battery is replaced by an Incorrect Type. Dispose of Used Batteries According to the Instructions.

Operating Temperature

The guaranteed operating temperature range of this product is 0°C ~ 40°C (32°F ~ 104°F).

This product may not work properly if you run right after a long period of storage at a temperature below the guaranteed one.

Prior to using a device that has been stored for a long period in low temperatures, allow the product to stand at room temperature for a period.

Security Precautions

The initial administrator ID is "admin" and the password should be set when logging in for the first time.

Please change your password every three months to safely protect personal information and to prevent the damage of the information theft.

Please, take note that it's a user's responsibility for the security and any other problems caused by mismanaging a password.

CONTENTS

OVERVIEW	3	Important Safety Instructions
	4	Before Start
	5	Contents
	6	Features
	7	Part Names and Functions (Front)
	7	Part Names and Functions (Rear)

CONNECTING WITH OTHER DEVICE	8	Connecting to an external device
	8	Connecting the USB
	8	Connect Ethernet
	8	Connect power
	9	Connecting ground wire
	9	Connecting the Network

LIVE	10	Getting Started
	11	Live Screen Configuration
	13	Live Screen Mode
	14	Audio ON/OFF
	15	Set up layout
	15	Set up launcher
	15	BNC layout settings

MENU SETUP

17

17	System Setup
21	Setting the Device
24	Network Configuration

APPENDIX

26

26	Product Specification
27	Product Overview
27	Default Setting
28	Troubleshooting
29	Open Source License Report on the Product







FEATURES

This product can play back the video and audio captured by network cameras.

- User-friendly UI
- Supports a range of 4K camera resolutions (3840X2160, 4096X2160, 4000X3000)
- Outputs a 4K high definition image using HDMI
- Supports ONVIF Profile S standard and RTP / RTSP protocols
- 49 channels simultaneous output (HDMI: 32 channels, VGA: 16 channels, BNC: 1 channel)
- Installation Wizard Function (Easy Setup)

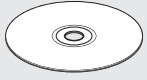
Package Contents

Please unwrap the product, and place the product on a flat place or in the place to be installed.
Please check the following contents are included in addition to the main unit.

		
Decoder	Mouse	User Manual CD
		
User Manual or Quick Manual	Terminal block	Taping screw
		
Plastic Anchor		

PART NAMES AND FUNCTIONS (FRONT)

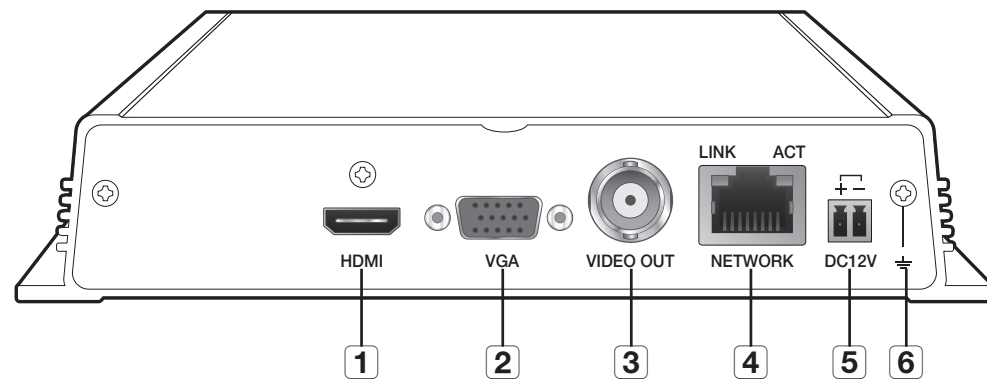

Part Names	Functions
1 HDMI	HDMI connector port.
2 VGA	VGA Video Signal Output Port.
3 VIDEO OUT	This is a BNC terminal to display video.
4 NETWORK	This is a terminal to connect to Ethernet cable. <ul style="list-style-type: none"> Power input can be provided using PoE. (Please see "Product specifications" for the PoE power specifications.)
5 DC12V	This is a terminal to connect a designated power supply.
6 Ground connection	Terminal to connect a separate ground cable. <ul style="list-style-type: none"> Add a ground cable to support the safe use of the device.

PART NAMES AND FUNCTIONS (REAR)

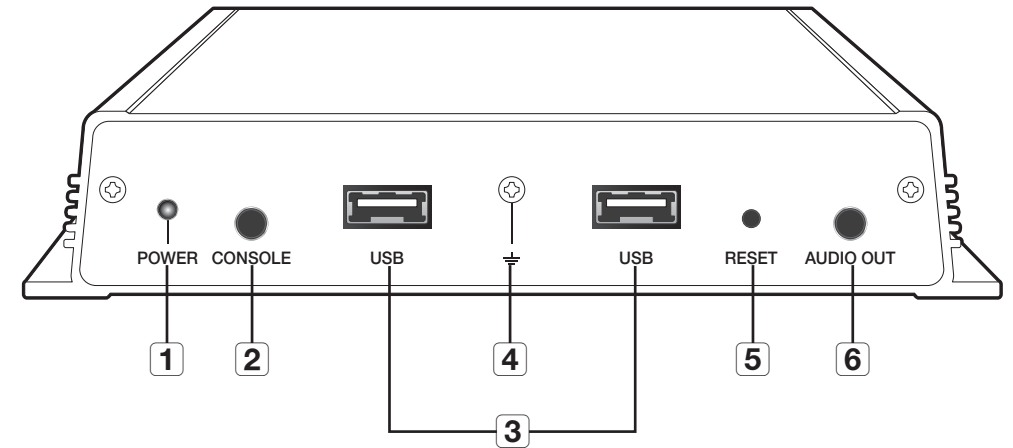

Part Names	Functions
1 POWER	It displays the power ON/OFF status using an LED. <ul style="list-style-type: none"> Normal operation: LED ON Abnormal operation: LED OFF
2 CONSOLE	[CONSOLE] is designed for the service repair purpose only.
3 USB	Connects the USB devices.
4 Ground connection	Terminal to connect a separate ground cable. <ul style="list-style-type: none"> Add a ground cable to support the safe use of the device.
5 RESET	This button can be used to initialize the device if you have forgotten your password. If you press and hold the button for about 10 seconds, the password initialization pop-up window will open, prompting you to reset the password.
6 AUDIO OUT	This is a terminal for voice signal output (3.5 π).

connecting with other device

CONNECTING TO AN EXTERNAL DEVICE

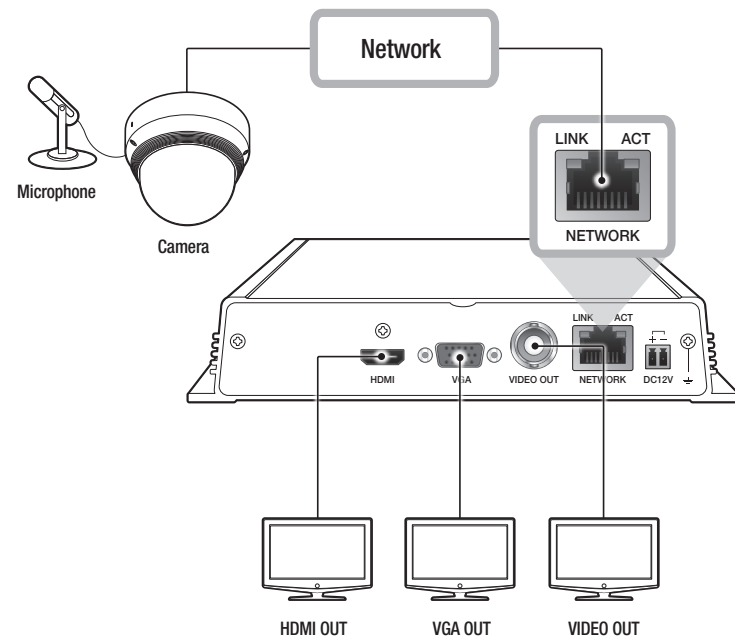

- ! Unrated or improper power source may cause damage to the system. Ensure that you use only the rated power source before pressing the POWER button.

CONNECTING THE USB

1. On the front of the product, there is a USB port.
2. You can connect USB memory or mouse to the USB port.
3. The product supports hot plugging function that enables connecting/disconnecting USB devices while in operating the system.

- ! Some USB devices may fail to function properly due to compatibility issue, please check the device before using.
- Only USB storage devices that comply with the standards (having a metal cover) are guaranteed for data transfer.
- In case if the USB device's electric contacts have been worn out, data transfer between the devices may not properly function.

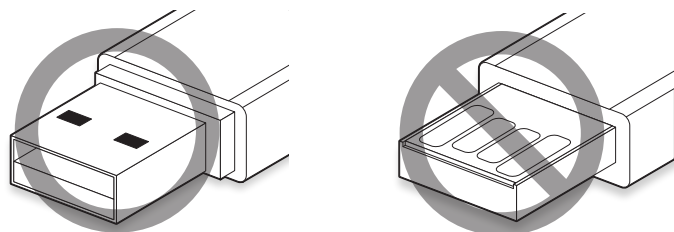

CONNECT ETHERNET

Connect the Ethernet cable to connect it to a local network or the internet. It can be connected without a power adapter by supplying power separately from the PoE switch.

- Please see "Product specifications" for the PoE power specifications. (Page 26)

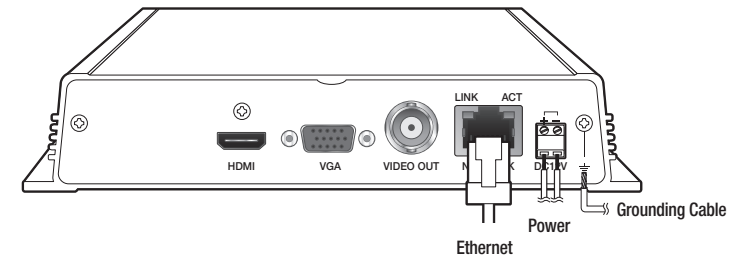

CONNECT POWER

When using a normal Ethernet cable, connect to the power adapter for power supply. Connect the (+, -) wires of the power adapter to the power input terminal of the network video decoder using a screwdriver.

- ! When using PoE and DC 12V power simultaneously, the device will be operated with the external power (DC 12V).
 - If you use and connect a router with a PoE function, no external power is required.
 - PoE should be compatible with IEEE 802.3af.
- As DC 12V has polarity, be careful when you connect it.
- When connecting external devices, you must first turn off the power to the devices.
- Connect the set and adapter power cable first, and then plug it into a wall socket rated 220V.
- Do not extend the adapter output cable.
- If you need to extend the power cable, contact the service center.

Power Cable Specification for Each Model

Input power	Wire Type (AWG)	Cable Length (Max.)
DC 12V	#18	19m
	#16	30m

CONNECTING GROUND WIRE

Connect the ground wire to the FG screw at the right side of the power input terminal using a screwdriver.

- ! Grounding protects the product from being damaged by lightning.
- When connecting, be sure to turn off the power to devices.

Recommended specifications for ground wire

- Length: Maximum 3M
- Thickness: 18AWG or thicker
Ex) UL1007 AWG18/16, UL1015 AWG18/16/14/12, UL2468 AWG18/16/14

CONNECTING THE NETWORK

- ✍ For more information about network connection, refer to "**Network Configuration**". (Page 24)

How to install the network video decoder

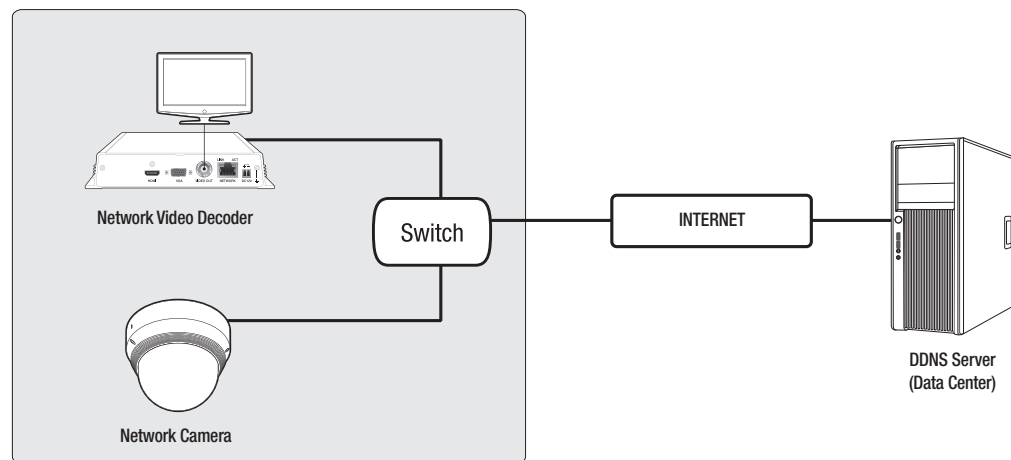

GETTING STARTED

Starting the system

1. Connect the decoder to the power supply.
2. Initialization will proceed in the order of the icons shown.
3. After step 3, the live screen will appear.



Install Wizard

As shown below, proceed through each step of the <Install Wizard>.

1. In the <Language> screen, select the language and press the <Next> button.
2. In the <ID/PW> screen, set the password and press <Next>.
3. In the <Network> screen, set the network access method and the access environment. To use a simple intranet, click <Next>.
 - Network (Camera) : Connects to the camera and receives the video feed from the camera
 - Network Setup
 - IP Type : Choose the network connection method.
 - IP Address, Subnet Mask, Gateway, DNS

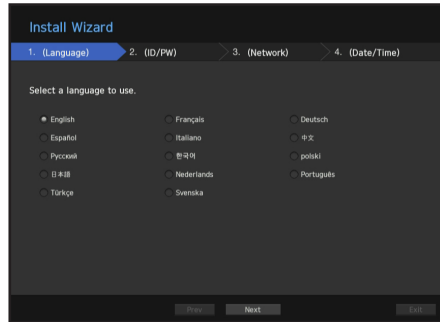

-  If the LAN cable is not connected to the port, the setting button will not be activated for use. Check the LAN cable connection.
 - For more details on network settings, refer to the user manual.

4. After setting the date/time settings in the <Date/Time> screen, click on the <Finish> button to launch the setting completion window.

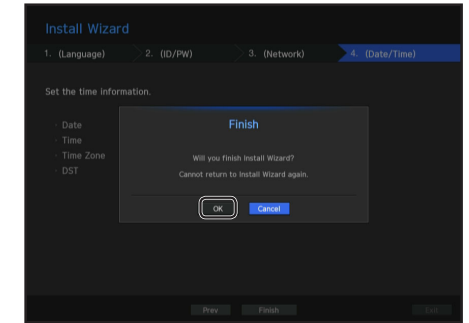

Shutting Down the System

1. In the live screen menu, select <Shutdown>.
2. The "Shutdown" confirmation pop-up window will appear.
3. Click on <OK>.
The system will shut down.



- Only the user with the "shutdown" permission can shut down the system.
- For the permission management, refer to "User > Setting Permissions". (Page 18)

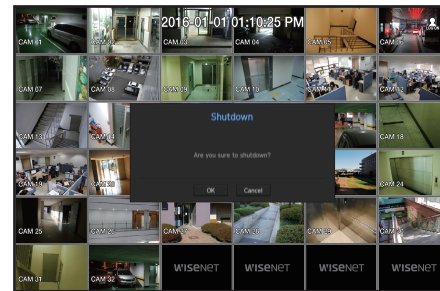

Login

To use the Decoder menu, you are required to login as a user that is authorized to access the applicable menu.

1. Right click with your mouse button on the live mode screen.
You will see the context menu on the screen as shown.
2. Select <Login>.
The login dialog appears.



- The initial administrator ID is set to "admin" and you will need to configure the password in the installation wizard.
- Please change your password every three months to safely protect personal information and to prevent the damage of the information theft.
Please, take note that it's a user's responsibility for the security and any other problems caused by mismanaging a password.

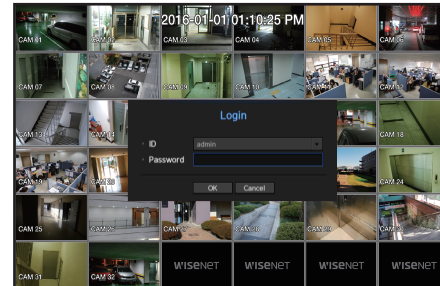

- For the restricted permission, refer to "User > Setting Permissions". (Page 18)

LIVE SCREEN CONFIGURATION

Icons on the Live Screen

You can check the status or operation of the Decoder with the icons on the live screen.

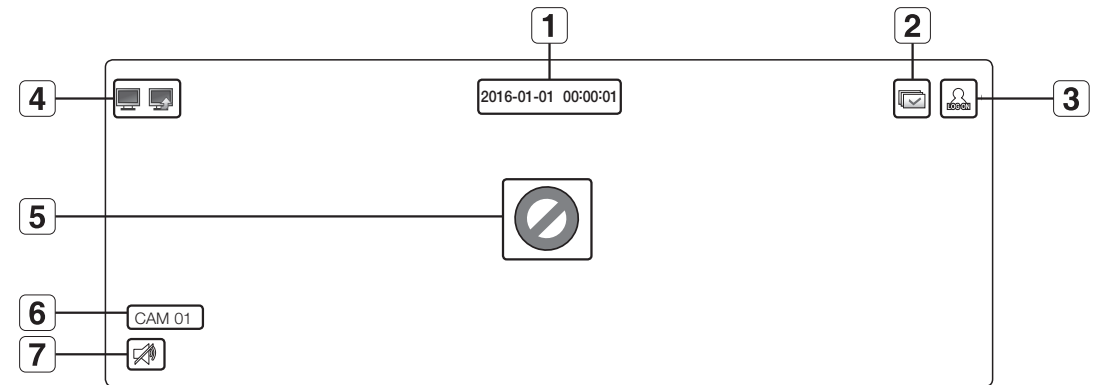

Name		Description
1	Current Date, Time	Displays the current time and date.
2	Screen Mode	It is displayed when all the channels are switched at the set time interval.
3	Login Information	When you are logged in, the "LOG ON" icon will be displayed.
4	System Operation	It is displayed when the network is overloaded. <ul style="list-style-type: none"> It occurs when the max receiving allowance is exceeded, causing an overload to the CPU. It will disappear if you modify the camera settings or delete a camera to reduce the performance burden.
		It is displayed when there is firmware to update the server.
5	Video Input Status	Displayed if no input is entered in the condition that the camera is set to <ON>.
		Displayed when the live image with the camera turned <ON> exceeds the supported resolution.
		wisenet It displays unsupported channels. (Display 32 channels of video in 36 splits)
6	Camera Title / Channel	Display the camera title and channel number.
7	Camera Operation	Displays AUDIO ON/MUTE. Not displayed in video mode if deactivated.

Live Screen Menu

If you right click with your mouse button in live screen mode, it will launch the live screen menu where you can access each menu.

The context menu differs depending on the state of Log in/out, split mode, and Decoder operation status.

Single Mode Menu

The single mode menu is available only in Single Mode.

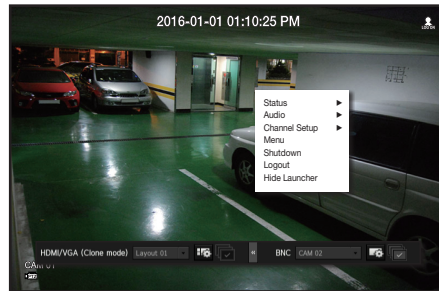

< Single Mode Menu >

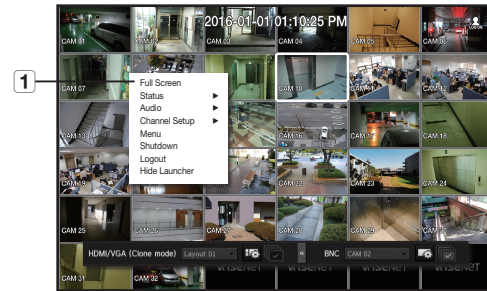

< One channel selection menu in the split screen >

Menu	Description
1 Full Screen	Select and click a desired channel in Split mode to switch to the full screen of the selected channel.

Split Mode Menu

In Live split mode, right-click to display this context menu as shown.

The context sensitive menu in split mode differs, depending on the login/logout status.

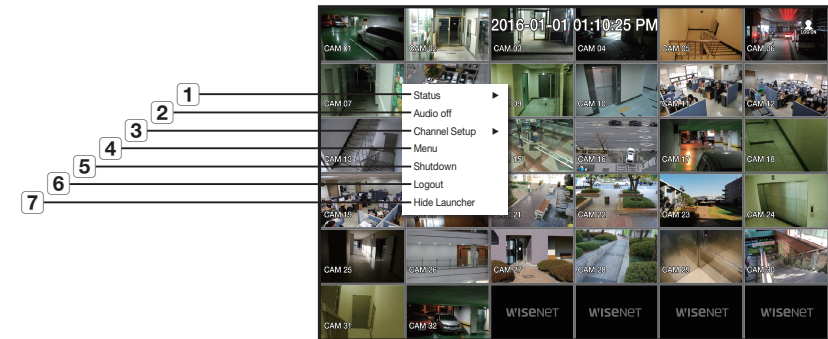

Menu	Description
1 Status	This shows the connection information and live status of the cameras connected to each channel. Please see "Status" . (Page 13)
2 Audio On/Off	Turns ON/MUTE the sound of the selected channel. Refer to "Audio ON/OFF" . (Page 14)
3 Channel Setup	Select single channel or multi-channel to change the settings of each channel. Refer to "Channel Setup" . (Page 14)
4 Menu	Enter the main menu. Refer to the menu settings. (Page 17)
5 Shutdown	The system shutdown dialog will appear.
6 Login/Logout	You can log in or out.
7 Show/Hide Launcher	Shows or hides the launcher.

LIVE SCREEN MODE

You can play up to 64 live video channels in single, 10-split, or auto sequence mode.

Method for displaying screen mode

If you want to change to split mode, select 'split mode' in the layout settings.

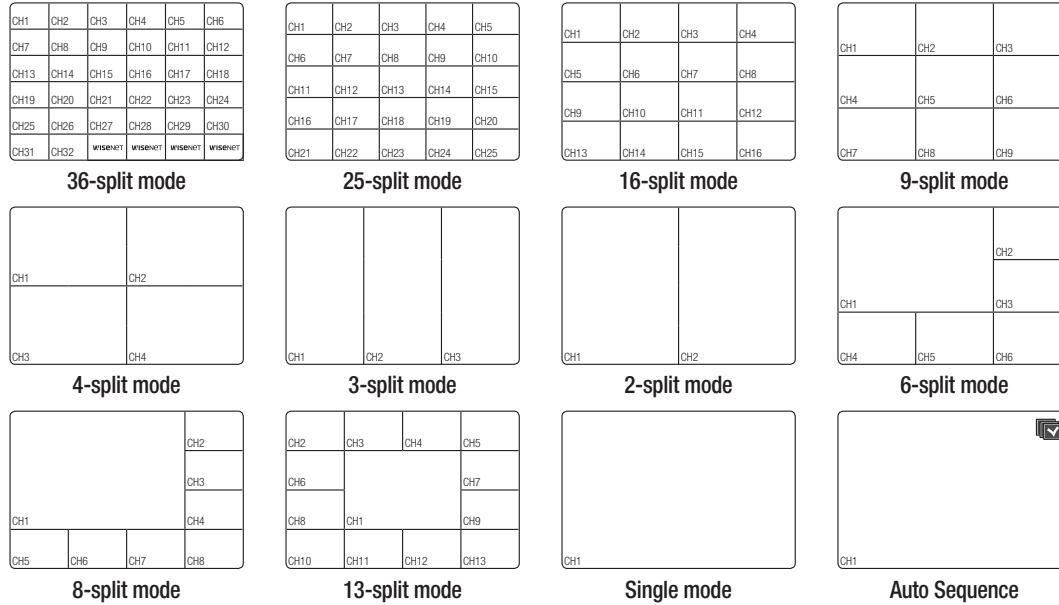



Status

You can check the connection information of the camera to be connected to each channel on the live screen.

Channel info

If you select <CH Info> in the <Status> menu on the live screen, the information of an incoming video on the live screen that you are currently monitoring is output.

-  The letter marked next to the model name indicates the protocol used when registering the camera.
 - S and V indicates Samsung protocol, O indicates ONVIF and R indicates RTSP.
-  If connected via RTSP or IPv6, it will not show the IP address.



Connection

If you select <Connection> in the <Status> menu on the live screen, you can check the connection state of the camera connected to each channel.

-  Please refer to "Register camera > Error code guide" for details regarding camera connection errors. (Page 21)

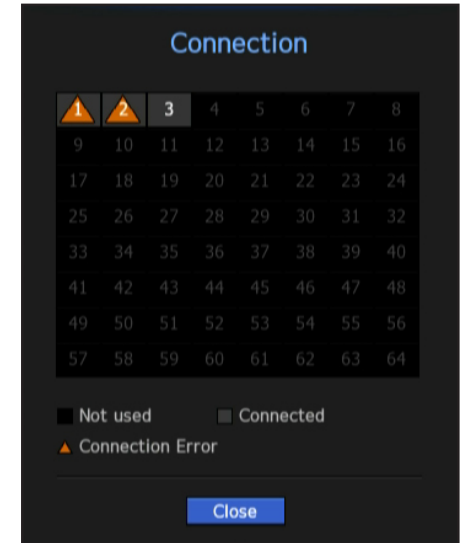

Live Status

If you select <Live> in the <Status> menu on the live screen, you can check the transmission information and state of the camera connected to each channel.

CH	Model	Status	IP Address	Codec	Resolution	Frame Rate
1	XNF-8110R	Connected	192.168.4.19	H.264	768X768	30fps
2	SNB-7002	Connected	192.168.4.44	H.264	800X600	20fps
3	-	-	-	-	-	-
4	-	-	-	-	-	-
5	-	-	-	-	-	-
6	-	-	-	-	-	-
7	-	-	-	-	-	-
8	-	-	-	-	-	-
9	-	-	-	-	-	-
10	-	-	-	-	-	-

- Model : Displays the camera model name connected to each channel.
- Status : Displays the status of camera connection set to each channel.
- IP Address : Displays the IP address of a camera set to each channel.
- Codec : Displays the live profile codec information for a camera set to each channel.
- Resolution : Displays the live profile resolution of a camera set to each channel.
- Frame Rate : Displays the live profile transmission rate for a camera set to each channel.

AUDIO ON/OFF

You can turn the sound on/off corresponding to the channel in Live mode.

AUDIO ON/OFF in Single mode

Click on the audio icon (🔊) on the screen to turn it ON/OFF.

- ✍️ If there is no sound even though the output settings have been properly configured, confirm that the connected network camera supports the audio function, and check to ensure that the audio settings are properly configured. The sound icon can be displayed if the sound signal fails to output from noise.
- Only the channel where <AUDIO> is set to <ON> in "Setting the Device > Camera" displays the audio icon (🔊) in Live mode that you can use to turn the sound on/off.

Channel Setting

While checking the video of registered channels, change the name of the channel to a name that makes sense for the video being captured.

1. Place the cursor over the camera name of each channel to display the <▼> key to the right on the screen.
2. Click a camera name to display a channel list where you can select a different channel.
3. Select a desired channel and click it. The current channel will be switched to the selected one. Use the cursor to select a channel to move, and drag and drop it to a desired channel; this can also change the channel position.
 - Ex : if switching CH 1 to CH 7



Switching to Single Mode

When in split mode, select and double-click a desired channel to switch to its Single mode.

- Ex : If double-clicking CH 3.

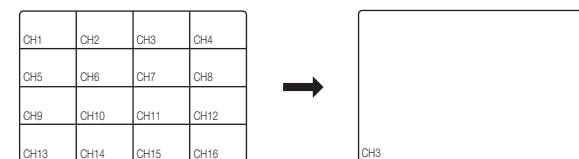

1 Rename single channel

Select one channel from the <Channel Setup> menu of the live screen, and click <Single Channel Change> to change the name of the channel.

- Please refer to "Use virtual keyboard". (Page 17)

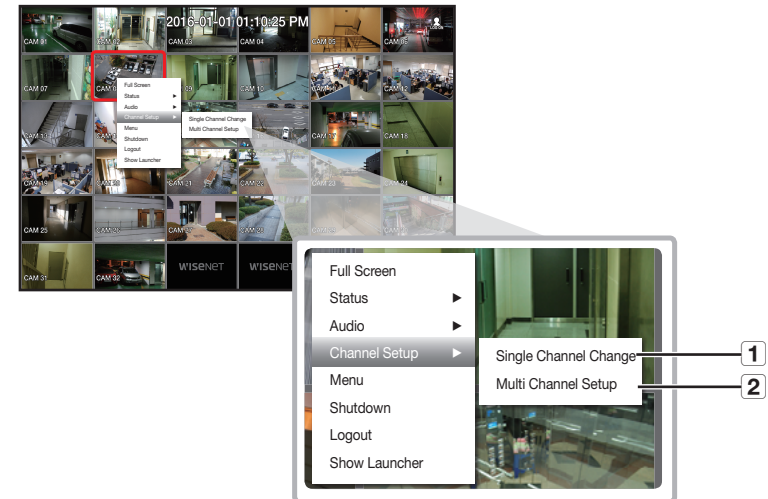

2 Set up multi-channels

You can set up anything related to video by channel.

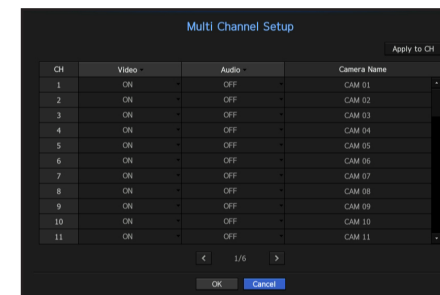

- Select the channel you want to change in live and move to <multi-channel settings>, and then the focus will shift to the video. You can change related information immediately by referring to the selected video.

- ✍️ Please see "Channel Setting" for details about the settings. (Page 23)

SET UP LAYOUT

You can set up the layout of each channel from the live screen.

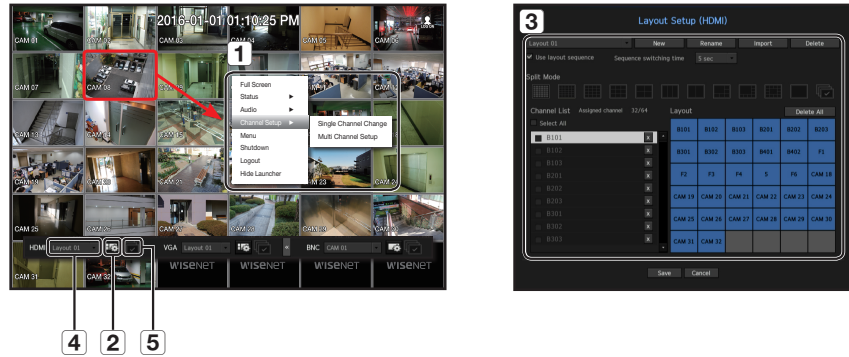

- 1 Designate the channel name related to the video through the single channel or multi-channel settings in the live screen.
Please see "Channel Setting".
- 2 Run the layout settings screen at launch.
- 3 Set up layout by composing the split screen mode with channel names.
You can set up multiple desired layouts at the same time.
- 4 After settings, you can check it out while changing layout, and change the order of channels by clicking with the mouse in the relevant order.
- 5 It will replay the live screen using different layouts in consecutive order for the sequence setting time.
 - Check <Use layout sequence> in the layout settings window to set up the sequence conversion time.

SET UP LAUNCHER

You can set up the video output layout by using the launcher menu at the bottom of the live screen.

1. Select <Show launcher> from the live screen menu.
2. Click the launcher menu on the bottom of the screen to enter the menu directly.



- If there is no input within 10 seconds, it will disappear.
- The launcher menu can only be selected by clicking.

- **Layout 01** : Select the layout to be displayed on the screen from among the layouts you set up. This is a layout list batch added from the HDMI/VGA layout settings page, and will be changed when you change it.
- **CAM 01** : It shows the list of cameras registered at BNC layout, and only those cameras can be selected.
- : Set up, change or delete the layout of each channel.
- : Run the sequence.

HDMI/VGA layout settings

Bundle channels based on user needs, to check them immediately when necessary.

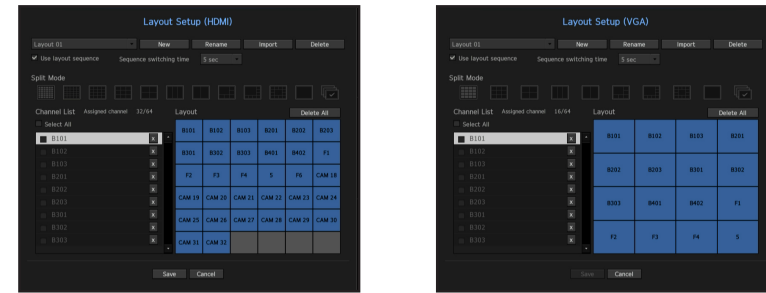

1. Select < >.
 - The layout settings window will appear.
 - New : You can set up a new layout.
 - Rename : Select the layout you want to set up and change the name.
 - Import : Select and import layouts from the layout list (HDMI, VGA) you have set up already.
 - Delete : You can delete a layout you set up previously.
 - Use layout sequence : Select whether or not you want to use the layout sequence.
 - Sequence switching time : The time when the layout split screen is automatically converted is set up.
 - Split Mode : Select split mode from the layout mode.
 - VGA layout supports up to 16 splits. However, the layout with 25 and 36 splits will be excluded from the HDMI layout list while importing the layout list.
 - < > is a single channel sequence, and will be excluded from the layout sequence operation of the live launcher.
 - **Use layout sequence** : Live launcher sequence is a layout sequence, and it will be included in the sequence usage and selection in the layout settings page.
 - Select channel: Select the channels which compose the layout.
 - Drag the channel selected from the layout at the right of the screen to move the channel.
2. Push <Save> to save the layout.
 - VGA layout and settings can be accessed through "Devices > Monitor > Expand".

BNC LAYOUT SETTINGS

BNC sequence will be operated through the selected channels.

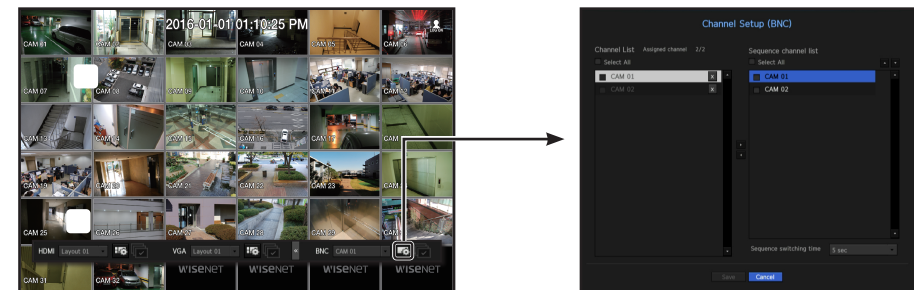

- BNC channel settings and sequence can be used when "Devices > Monitor > BNC Output" in the settings is selected as <ON>.

Configure live monitoring

- Please see each page for details of settings.
 1. Camera registration (Page 21) > 2. Designate Live channel name (Page 14) > 3. Layout settings (Page 15) > 4. Layout monitoring (Page 15)

1. Camera registration

The first screenshot shows a menu with options: Full Screen, Status, Audio, Channel Setup, Menu, Shutdown, Logout, and Show Launcher. An arrow points from 'Channel Setup' to the 'Setup' screen.

The 'Setup' screen has a 'Camera' menu item. An arrow points to the 'Camera Register' screen.

The 'Camera Register' screen shows a table of registered cameras:

CH	Preview	Protocol	Model	IP Address	Connection	Data Rate
1	Preview	SAMUNG	SNB-7002	192.168.4.44	Connected	0.1Mbps (0.1%)
2	Preview	SAMUNG	SAMUNG CAM	192.168.4.19	Error 01	0.0Mbps (0.0%)

The second screenshot shows a table of camera details:

Model	IP Address	MAC	Port	Network	Connection
PRO-900R	192.168.4.26	00:99:18:01:06:4E	4530	I	-
QW-700R	192.168.4.30	00:16:C7:75:F8	4530	I	-
SNB-7002	192.168.4.44	00:99:18:30:17:84	4530	I	Registered

2. Designate Live channel name

The first screenshot shows the same menu as in step 1. An arrow points from 'Channel Setup' to a keyboard input screen.

The keyboard input screen shows the text 'B101' being entered.

The second screenshot shows the 'Multi Channel Setup' screen with a table:

CH	Video	Audio	Camera Name
1	ON	OFF	B101
2	ON	OFF	B102
3	ON	OFF	B103
4	ON	OFF	B201
5	ON	OFF	B202
6	ON	OFF	B203
7	ON	OFF	B301
8	ON	OFF	B302
9	ON	OFF	B303
10	ON	OFF	B401
11	ON	OFF	B402

3. Layout settings

The first screenshot shows a 16-camera grid layout. An arrow points to the 'Channel Setup (BNC)' screen.

The 'Channel Setup (BNC)' screen shows a list of channels: B101, B102.

The second screenshot shows the 'Layout Setup (HDMI)' screen with a grid layout. An arrow points to the 'Layout Setup (VGA)' screen.

The 'Layout Setup (VGA)' screen shows a grid layout with channels B101 through B303.

4. Layout monitoring

The screenshot shows three monitors displaying live camera feeds. Above the monitors is a control bar with the following settings:

- HDMI PARKING
- VGA ELEVATOR
- BNC B101

The monitors are labeled: HDMI OUT, VGA OUT, and BNC OUT.

menu setup

System environment, device and network can be set up.

SYSTEM SETUP

You can setup Date/Time/Language, User, System Properties and Log.

Date/Time/Language

Setting the Date/Time/Language

You can check and setup the current Date/Time and time related properties, as well as the language used for the interface on the screen.

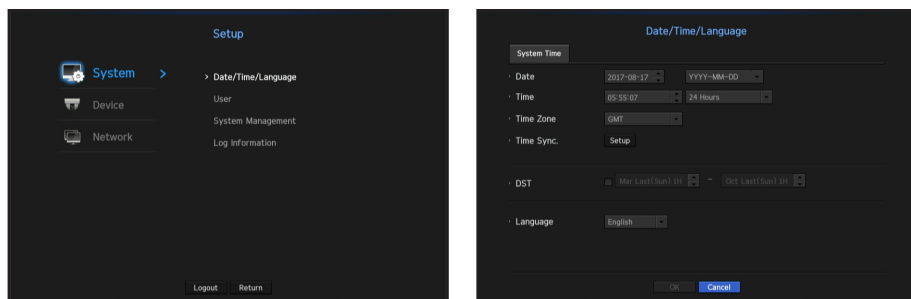

- Date : Sets the date and its format that will appear on the screen.
- Time : Sets the time and its format that will appear on the screen.
- Time Zone : Sets the time zone of your area based on the Greenwich Mean Time (GMT).
 - GMT (Greenwich Mean Time) is standard World Time and the basis of world time zone.
- Time Sync. : Specify the use of synchronization with the time server.
Click the <Setup> button to display time synchronization setup screen.
If you select to use the <Time Server>, the current time will be synchronized on a regular basis by the server defined as <Time Server>.
If this is the case, you cannot change the time setting manually.
 - Synchronization : Specify the use of synchronization with the time server.
 - Time Server : Enter an IP or URL address of the time server.
 - Last Sync Time : Displays the most recent synchronization time from the selected time server.
- DST : Set up Daylight Saving Time with its period to make the time earlier than the GMT of its time zone by 1 hour during the set period.
- Language : Select your language. Sets the language for the interface.
English, French, German, Spanish, Italian, Chinese, Russian, Korean, Polish, Japanese, Dutch, Portuguese, Turkish and Swedish languages are supported.

User

You can set permissions of each user over the Decoder's specific function and settings.

Setting the Administrator

You can set and change Administrator's ID and password.
The administrator can use and set all menu items and functions.

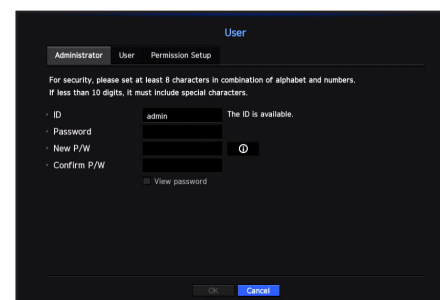

- ID : Change the admin ID.
- Password : Checks the current password.
- New P/W : Enter new password.
- Confirm P/W : Confirms the new password.
 - If <View password> is selected, the password will no longer be hidden on the screen when you type it.



- The initial administrator ID is set to "admin" and you will need to configure the password in the installation wizard.
- Please change your password every three months to safely protect personal information and to prevent the damage of the information theft.
Please, take note that it's a user's responsibility for the security and any other problems caused by mismanaging a password.
- If you click <View password>, a basic guide for password setup is displayed.

Using Virtual Keyboard



1. For alphanumeric inputs, the virtual keyboard window appears.
2. Using a mouse, click on the desired character tab.
3. In the upper text input box of the virtual keyboard, there displays a list of candidate words containing the selected character.
4. Select a word from the list, or use the keyboard to enter the whole word.
 - If there are many of candidate words, use <Left> <Right> buttons to move between them forward and backward.
5. Select <OK>.
Entered word is applied.
 - For upper case letters, use <Caps Lock> button.
 - For special characters, use <Shift> button.
 - Using the virtual keyboard is the same to a normal keyboard use in your region.
 - ID allows alphanumeric characters only.
 - The password should at a minimum be an 8-digit combination of alphabetical letters and numbers.

User setting

You can create a group or set permissions for each group.
You can add a user and edit the registered user information.

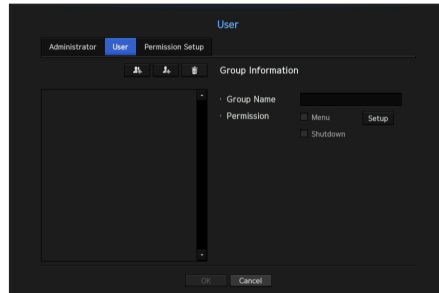

If you want to add a group

1. Click on the [] button to launch the Group Addition popup window.
If you want to add a group, click on <OK>.
2. Press the group name item to launch the virtual keyboard used to enter group names.
Enter the group name to register.
 - You can add a maximum of 10 groups.

If you want to set group permission

Set permission to access each group.
Each group's users can only access items with a check mark beside them.

1. Select the menu to set group permissions.
The menu with access permissions will appear when a user of the group logs in.
 - Menu : You can select and set the setting menu that can be accessed. A group user can only access the menu selected. If you select the menu, the menu permission setting screen will be displayed.
 - Shutdown : Authority for exiting the system will be given.
2. Click <OK>.
Check a group user to give them the permission to access the selected item.

If you want to register a user

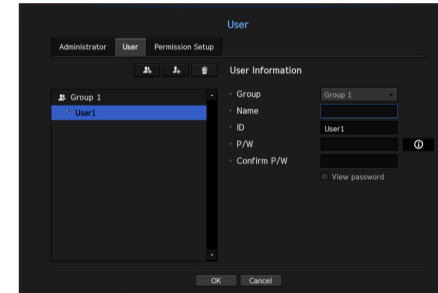

1. Click on the [] button to launch the user addition popup window.
To add a user, click on <OK>.
2. Select a group.
When registering a user, the selected group will be automatically registered.
 - A group can be changed after inputting all required information.
3. Enter name, ID and password.
4. Click <OK>.
Registered user information will be saved.

When you want to delete the group and user information

1. To delete, click on the [] button.
2. The deletion confirmation window will appear and you can select an item to delete and click on <Delete>.

Setting Permissions

You can set up an automatic log-out time and whether you are required to enter an ID manually or not.

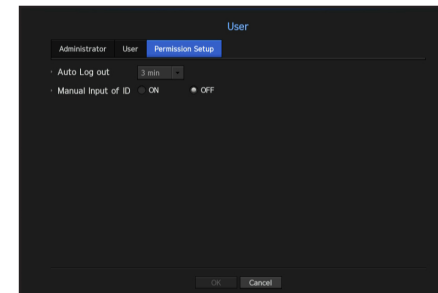

- Auto Log out : A user will be automatically logged out if there is no operation on Decoder for over set period of time.
- Manual Input of ID : In the login window, select whether to enter ID.

If the user has restricted access

If a new group is restricted to access the entire menus, the users belonging to the group can access only the basic menus and can change only their respective password.

If all permissions are restricted, you will see only some menu items accessible in the Live screen menu.

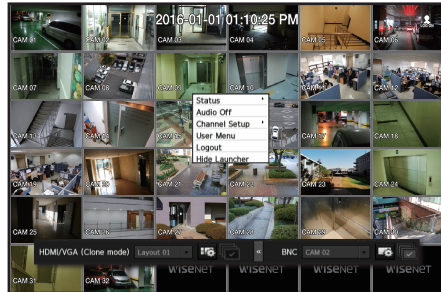

To change the user password

If you log in with the user account of a group with restricted access, you just can change your own password.

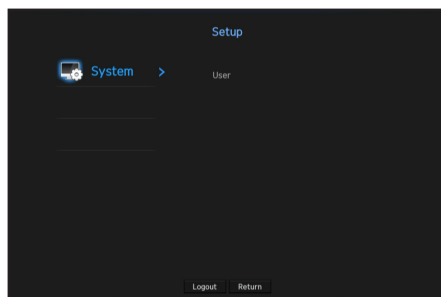

1. Provide the login information.
2. Select <User Menu>. The Permission Management screen appears.
3. Select <User>. The Password dialog shall appear.
4. Provide a new password.
5. Select <OK>. The old password will be changed to a new one.

System Management

You can check the current system version and upgrade to the newest version, or run settings, backup or initialization of settings.

Checking the System Information

You can check the current software version and MAC address before proceeding with the upgrade.

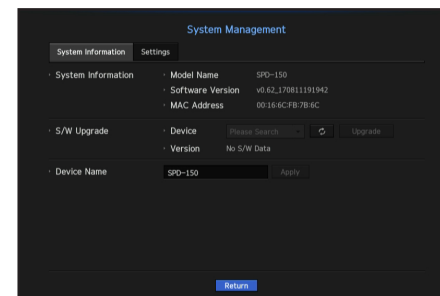

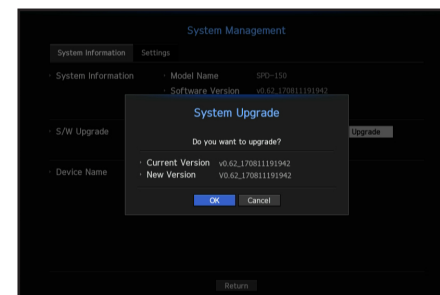

- System Information : Shows the current system's information. The values can not be changed by a user.
- S/W Upgrade : Updates the Decoder's software up to date.
 - Press the <  > button to search for and display the equipment to upgrade.
- Device Name : This is the name of the decoder.

To upgrade the current software version



1. Connect a device storing the software to be updated.
 - It may take about 10 seconds to recognize the device.
 - Upgradeable devices include USB memory, and network device.
 - When the network is upgraded, the current decoder must be connected to the network. Upgrade via the proxy server may not be enabled due to the restricted access.
2. Select <System Management> from <System> window.
3. Select <System Information>.



menu setup

- When the recognized device appears, select **<Upgrade>**.
 - If you connect a device in the upgrade menu window, you can press the  button to search for available software.
 - If there is an upgrade image on the network, the popup window will appear.
 - The **<Upgrade>** button will be activated only if the current **<Software Version>** of the **<System Information>** is same to or older than that of **<S/W Upgrade>**.
 - Press **<OK>** in the "S/W Upgrade" window.
 - While updating, it shows the progress.
 - When the updating is done, it automatically restarts.
Do not turn the power off until it finishes restarting.
-  If **"Upgrade Failed"** appears, retry from the step 4.
When you experience continued failure, consult the service center for assistance.

Settings

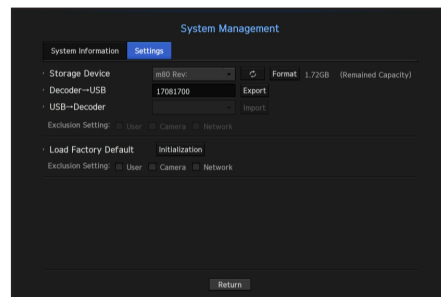
You can copy and import the Decoder settings by using a storage media.



- Storage Device : Shows the connected storage device.
 - Press the  button to view the list of storage devices.
 - Format : Connected USB device will be formatted.
 - Export : Exports Decoder settings to the connected storage device.
 - Import : Imports Decoder settings from the storage device and applies to the Decoder.
 - Uncheck the checkbox of an item(s) that you want to import.
Only the other items than the selected one will be applied to the Decoder.
 - <Export>** and **<Import>** settings should be used in the same software version.
 - Load Factory Default : Restore the factory default settings of Decoder.
Uncheck the checkbox of an item(s) that you want to reset. Then, only the other items than the selected one will return to the factory default.
If **<Initialization>** is selected, a confirmation dialog for "Load Factory Default" prompts. Press **<OK>** to initialize the system to the factory default.
-  If you want to initialize the **<Authority Setting>**, you need to reset the password.
In case you reboot, reset it the Installation Wizard and if not, use the guide screen to reset it.

Log Information

You can check out the record information related to the system.

Checking the system log

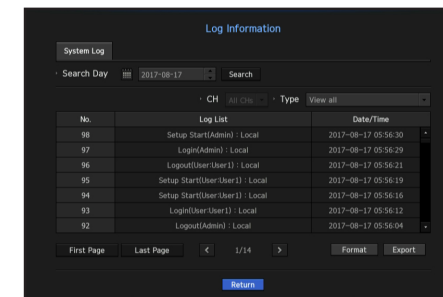

System Log shows log and timestamp on every system start up, system shutdown, and changes on system settings.

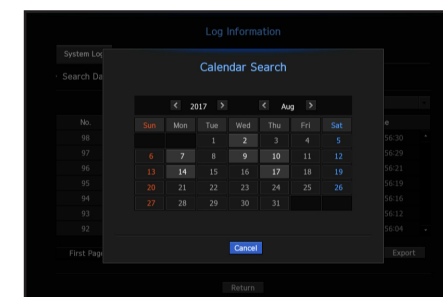

- Search Day : Click the Calendar icon to display the calendar window, or use the direction buttons to specify the search period of the system log.
- Search : Specify the date and press this button to display the search result in the log list.
- Type : When there are too many logs, you can display logs of the desired format by selecting the type.
- Format : Connected USB device will be formatted.
- Export : Save all the logged information recorded in the Decoder into the storage media.

If you want to use the calendar



- Select a year and month.
Push the ,  key located at the left or right of the year and month to change the year or month in increments of one.
- If you click dates on the calendar, the date will be selected.
 - The dates with data to be searched will be indicated in gray.

SETTING THE DEVICE

You can set up content related to the camera and monitor.

Camera

To register a camera

You can register a network camera for each channel and make connection between.

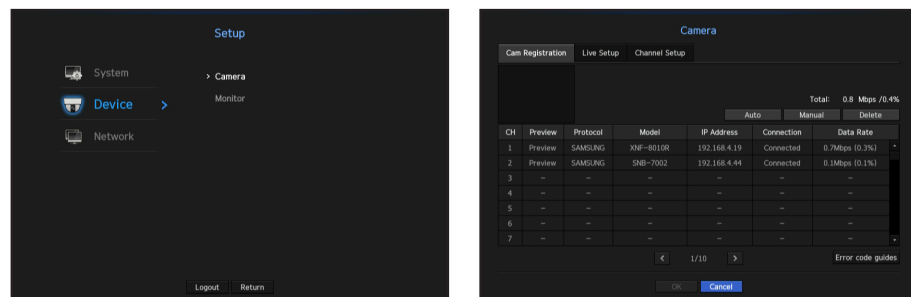

- Preview : View the video of the channel as a current image.
 - Camera searched with ONVIF does not provide previews.
- Protocol : Show the protocol information of a registered network camera.
- Model : Show the camera model name.
- IP Address : Display the IP address of a network camera.
- Connection : Display the connection status.
- Data Rate : Displays the total amount of data received by the channel.
- Error code guide : you can check the details of error codes.
 - Connection failed : The connection has failed due to an unknown error
 - ID/PW authentication failed : ID or PW is incorrect when registering a camera
 - Allowed number of users for camera exceeded : The maximum number of users when registering a camera has been exceeded
 - Unsupported video format : When trying to connect with an unsupported video format in the process of registration
 - 5 times authentication failure : The account of the camera has been locked since ID/PW authentication has failed five times when attempting to register the camera.
- If the Decoder has been initialized, it may not connect to cameras. Configure the network settings first and add cameras. For more information on network settings, refer to "**Network Configuration**". (Page 24)

To auto-search for and register a network camera

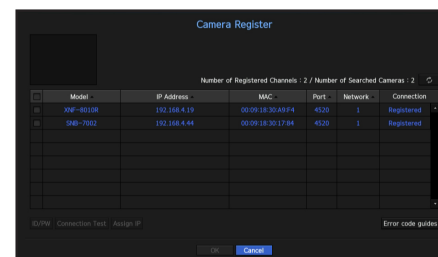

1. In the <Cam Registration> field, click on the <Auto> button.
2. Search for a network camera connected.
 - An already registered camera will be marked in blue in the list.
 - If you search for the camera again or if the IP is an old IP that was not assigned by the DHCP server (such as -192.168.1.100), then press the <Refresh> button to check if a new IP has been assigned. If the IP is still the same, then select Assign IP to assign the IP manually.
3. Select a camera from the camera list to see a preview of its current video feed.
 - Camera searched with ONVIF does not provide previews.
4. Check the checkbox next to a network camera that you want to connect to.
 - You can select all of the network cameras in the list and provide <ID> and <Password> all at once.
 - Click a header at the top of the list to sort the list according to that header.
- ! Registering camera with user account other than admin may restrict camera function.
 - When you change the camera ID/password in the camera web viewer, if the camera is already registered in Decoder, you also have to change the camera ID/passowrd information registered in Decoder.
5. Click on the <ID/PW> button to enter the selected network camera's <ID> and <Password>.
6. Press the <Connection Test> button to make a connection to a camera.
7. Press <Register> to register the selected camera.

If you want to add and register a network camera manually,

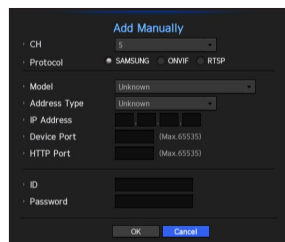

1. In the <Cam Registration> menu, click on the <Manual> button.
2. The manual addition window will appear.
3. Select a channel and protocol used to connect to a camera.
The input items may differ depending on the selected protocol.
 - SAMSUNG : Comply with the internal network protocols adopted by Hanwha Techwin.
 - ONVIF : Means the camera supports ONVIF protocols. When connecting a camera that its name cannot be found from the list, select <ONVIF>.
 - RTSP : Comply with RFC 2326, one of "Real Time Streaming Protocol (RTSP)" for real-time streaming.
4. If you select the <SAMSUNG> protocol, check options as necessary.
 - Model : Select a camera model.
 - Samsung Network Camera/Encoder : Means the camera/encoder supports Hanwha Techwin's SUNAPI, SVNP protocol. When connecting a camera that does not appear in the camera list, select Samsung Network Camera/Encoder.
 - However, you must select the correct model name of the camera, if it's in the list. Some of obsolete camera models may not be supported.
 - The below models are discontinued. If you register them with ONVIF, some camera functions will be restricted or cause errors. It is recommended you register the Samsung protocol.
 - SNB-2000, SNB-3000, SNC-B2315, SNC-B2331, SNC-B2335, SNC-B5368, SNC-B5395, SNC-B5399, SNC-570, SNC-1300, SND-460V, SND-560, SND-3080, SND-3080C, SND-3080CF, SND-3080F, SND-3081, SNP-3301, SNP-3301H, SNP-3350, SNP-3370, SNP-3370TH, SNP-3750, SNV-3080, SNP-3430
 - Address type : Select an address type of the camera.
 - Address type can be different depending on connected product model.
 - Static(IPv4)/Static(IPv6) : Used to provide the IP address of the camera manually.
 - Wisenet DDNS : This is available only if the camera is registered with the Wisenet DDNS(ddns.hanwha-security.com) server. Provide the registered domain for DDNS ID.
 - Ex) https://www.samsungjipolis.com/snb5000 → provide "snb5000" for iPOLiS DDNS

✍

 - The DDNS specifications supported by each camera can be found in the user manual for the camera.
 - URL : Used for URL address input.
 - When registering the WN5 camera URL, the device port should be changed to 554.

- IP Address : Provide the IP address of the camera.
- Device Port : Provide the device port of the camera.
- HTTP Port : Provide the HTTP port of the camera.
- ID : Provide the ID of the camera that you want to register.
- Password : Enter the password of the camera to be registered.

5. Select <ONVIF> or <RTSP> for the protocol and enter your input for each field appears.

- ONVIF Address / RTSP URL : Enter the camera's RTSP access address that supports ONVIF or RTSP. Please see the user manual for each camera for details on the RTSP address for access.
- ID : Enter the ID for accessing via ONVIF/RTSP protocol.
- Password : Enter the password for accessing via ONVIF/RTSP protocol.
- Mode : If <More Detail> button clicked, setup window will appear. Select a mode that is supported by the network camera in RTSP connection mode.
 - TCP : The connection type with the network camera will switch to "RTP over TCP".
 - UDP : The connection type with the network camera will switch to "RTP over UDP".
 - HTTP : The connection type with the network camera will switch to "RTP over TCP (HTTP)".
 - HTTPS : The connection type with the network camera will switch to "RTP over TCP (HTTPS)".

If you want to check the error details of camera registration

If you failed to register a camera, the reason for the failure will be displayed.

- **Connection failed due to unknown error.** : This message appears if the camera has failed to be registered due to unknown connection status.
- **Due to the camera account locking, access has failed.** : When you enter a wrong ID/password 5 times to login to the camera account, this message is displayed. Try to log in again after 30 seconds. If the same message appears, you may need to check whether someone has tried to access your camera account from the outside.
- **Connected successfully.** : This message appears if the camera is connected successfully.
- **Incorrect model information. Provide the correct model information.** : This message appears if the model information provided for registering the camera is incorrect.
- **Authentication has failed** : This message appears if the ID or password provided for registering the camera is incorrect.
- **Connection has failed due to excessive concurrent users.** : This message appears if the concurrent user count exceeds the upper limit.
- **Connection has failed due to incorrect HTTP port information.** : This message appears if the HTTP port number of the camera is invalid.
- **Connection has failed. Unknown connection status.** : This message appears if the camera has failed to be connected due to a unknown error.
- **User Model Modification** : When registering a new camera, it is named according to the device's default if user set the model to <Samsung Network Camera/Encoder>. In case if automatic registration fails, user can change the model name of camera to be registered.

To edit camera profile

When a camera is added for the first time, it is added as the default profile of H.264, H.265 and MJPEG in order temporarily.

If you want to change the profile, you can change it from "**Live settings**" directly.(Page 23).

- ✎ For the decoder, the profile will differ according to the split screen. Please see "**Set up Live > Replace Live**". (Page 23)
- For a single camera, the frame can be guaranteed when sending one profile, but if multiple profiles are sent, the frame to be transferred cannot be guaranteed. As the camera is connected to multiple devices, when you are sending two profiles at 30fps, you will only be able to send it at 20fps even though it is set up for 30fps.

Live Setting

You can change the live transfer settings of the network camera.

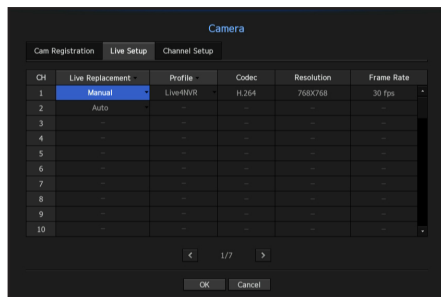

- **Live Replacement** : You can select the live profile setup mode. (Apply methods for HDMI, VGA)
If you select **<Manual>**, the profile setup items are enabled, and you can change settings manually.
 - **Auto** : For the live monitoring profile, when split mode is used, it will show the Live4NVR profile (default: H.264 800*600 30fps) which was created when you register it; when in single/2/3/4 split mode, it will automatically select the 2nd profile.
 - **Manual** : Live monitoring is performed with the profile selected by the user from the registered camera profiles.
- ✎ In the Replace Live item, when **<Manual input>** is selected, an icon indicating the resolution is too high (🖥️) may appear due to the split screen.
- **Profile** : You can select the video profile of the connected camera setting.
- **Codec** : Show the codec of the selected recording profile.
- **Resolution** : Show the resolution of the selected profile.
- **Frame Rate** : Show the frame rate of the selected profile.

Channel Setting

You can configure the video settings for each channel.

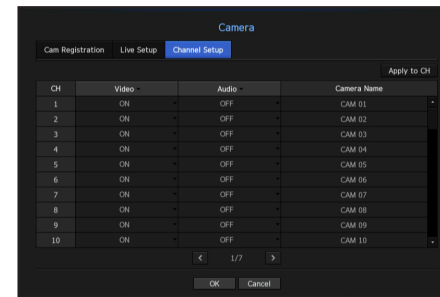

- **Apply to CH** : If you select **<Apply to CH>**, the "**Apply to CH**" confirmation window will appear. After selecting channels that the settings will be applied to, click on **<OK>** to apply them to the selected channels.
- **Video**
 - **<ON/OFF>** : You can turn ON/OFF the selected channel's camera.
 - **<Covert1>** : Shows information other than the video of the selected channel.
 - **<Covert2>** : It displays an empty screen rather than all information of the selected channel.
- ✎ If the channel is set to **<Covert1>** or **<Covert2>** mode, the channel's sound is not hearable.
- **Audio**
 - If set to **<ON>**, you can turn the audio of the channel ON/OFF on the Live screen.
 - If **<OFF>** is set up, audio will not be output from Live screen.
- **Camera Name** : Provide a camera Name.
 - You can enter up to 15 characters including space.



Monitor

You can set the information displayed on the monitor as well as the output system.

Monitor settings

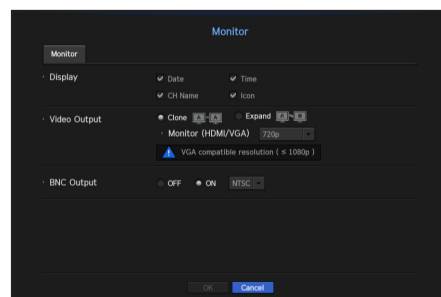
You can configure the monitor output-related settings including the displayed information, dwell time and output system.



- Display : Displays only checked items on the monitor screen.
 - Video Output : Selects either Clone or Expand mode to output the video, and sets the resolution of HDMI and VGA.
 - Clone mode: You can set the resolution of the main monitor (HDMI) and the sub monitor (VGA) as identical to each other.
 - When operating in copy mode, if the resolution is set to a value exceeding 1080p, no image will be displayed on the sub monitor.
 - Expand mode: You can separately set the resolution of the main monitor (HDMI) and the sub monitor (VGA).
 - BNC Output : This sets up whether you select BNC output or not. (NTSC/PAL can be selected)
-  ▪ If you set up extension mode, then you can use the VGA layout and layout sequence function from the live launcher.
-  ▪ You have to select ON for BNC output to use the BNC channel and channel sequence function from live launcher. Please see "**Set up launcher**". (page 15)
-  ▪ When you copy, if you select the extension mode or BNC output, video output of specific resolution via HDMI may be restricted, and it will be displayed as .

NETWORK CONFIGURATION

Users can set up the network to connect network cameras.

Interface

You can set the network connection route and protocol.

Setting a network connection

Sets the protocol and environment of the network.

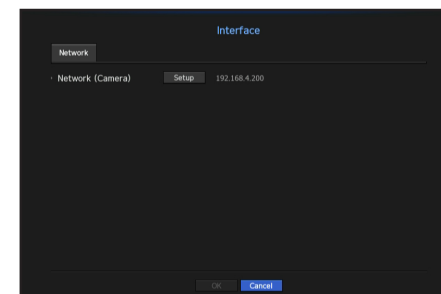
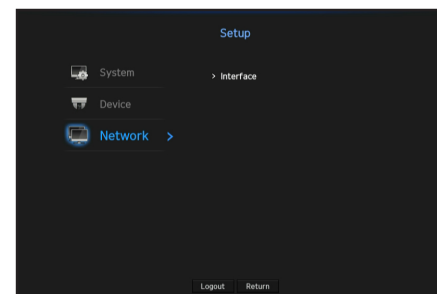

- Network (Camera) : Port recommended for camera connection, which receives a image from the camera.
 - Network (Camera) setup
 - IP Type : Select a network connection type.
 - IP Address, Subnet Mask, Gateway, DNS
 - Static : You can manually enter IP address, subnet mask, gateway and DNS.
 - DHCP : IP address, subnet mask and gateway values will be automatically set.
-  ▪ You can enter the DNS value of DHCP only when Manual input is selected.

Connecting and Setting the Network

Networking may differ from the connection method, check your environment before setting the connection mode.

When no router is used

• Static mode

- Internet connection : Static IP, leased line allows connection.
- Decoder Network Settings : Set the <Network> in <Interface> menu of the connected Decoder to <Static>.
 - Consult your network manager for IP, Gateway and Subnet Mask.

• DHCP mode

- Internet connection : Connect the Decoder directly to a cable modem, DHCP ADSL modem or FTTH network.
- Decoder Network Settings : Set the <Network> in <Interface> menu of the connected Decoder to <DHCP>.

When a router is used



- To avoid IP address conflict with the Decoder's static IP, check followings :

• Setting the Decoder with a static IP

- Internet connection : You can connect the Decoder to a router which is connected to an PPPoE/Cable modem or a router in a Local Area Network (LAN) environment.

• Setting the Decoder Network

1. Set the <Network> in <Interface> menu of the connected Decoder to <Static>.
2. Check whether the set IP address is in the static IP range provided by the Broadband Router.
IP Address, Gateway, and Subnet Mask : Consult your network manager.
 - Check whether the set IP address is in the static IP range provided by the Broadband Router.



- If a DHCP server is configured with starting address (192.168.0.100) and end address (192.168.0.200), you should set the IP address out of the configured DHCP range (192.168.0.2 ~ 192.168.0.99 and 192.168.0.201 ~ 192.168.0.254).

3. Check the Gateway address and subnet mask are equal to those set in the Broadband Router.

• Setting the DHCP IP Address of the Broadband Router

1. To access the Broadband Router's configurations, open a web browser on the local PC that is connected to the Broadband Router and enter the router's address (ex : http://192.168.1.1).
2. At this stage, make the local PC's windows network configurations to the below example :
Ex) IP : 192.168.1.2
Subnet Mask : 255.255.255.0
Gateway : 192.168.1.1
 - Once connected to the Broadband Router, it prompts with password. While entering nothing to the User Name field, enter "admin" into the password field and press <OK> to access the router configurations.
 - Access the router's DHCP configuration menu and set its DHCP server activation, and provide the start and end address.
Set the start address (192.168.0.100) and end address (192.168.0.200).



- Above steps may differ from the router devices depending on the manufacturer.

PRODUCT SPECIFICATION

Item		Details	
H/W	Operating System		Embedded Linux
	Output	HDMI	1ch (up-to 4K)
		VGA	1ea (up-to 1080p)
		CVBS	1ch, 704x480 (30fps), 704x576 (25fps)
	External	Ethernet	1ea (10/100/1000BASE-T)
		USB	USB 2.0 2ea
		Audio Out	1 out
	Environmental	Operating Temperature	+0°C to +40°C(+32°F to +104°F)
		Humidity	20% ~ 85% RH
	Electrical	Power	DC12V, PoE(EEE802.3af)
		Power Consumption	Max. 8.4W(12VDC), Max. 8.4W(PoE)
	Mechanical	Color / Material	Dark Gray / Metal
		Dimension (WxHxD)	178 x 34 x 187.8mm (7.00" x 1.33" x 7.39")
		Weight	Approx. 0.68Kg

Item		Details	
S/W	Video	Codec	H.265/H.264/MJPEG
		Network Performance	200Mbps
		Max. Channel	49ch (HDMI: 32ch, VGA: 16ch, CVBS: 1ch)
		Max. Decoding Performance	120fps@8MP, up-to 12MP
		Division (/monitor)	Clone mode 1/4/6/8/9/13/16/25/36(32)/2V/3V
			Expand mode (HDMI) 1/4/6/8/9/13/16/25/36(32)/2V/3V (VGA) 1/4/6/8/9/13/16/2V/3V
	Layout	Up-to 20	
	Audio	Codec	G.711/G.726/AAC
	Management		Local GUI
	Time Setting		NTP/Manual

PRODUCT OVERVIEW

unit : mm (inches)

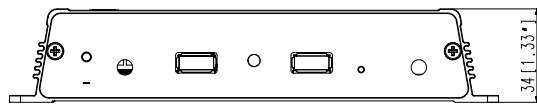
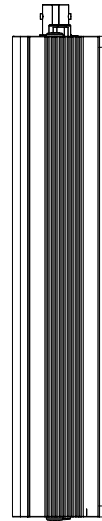
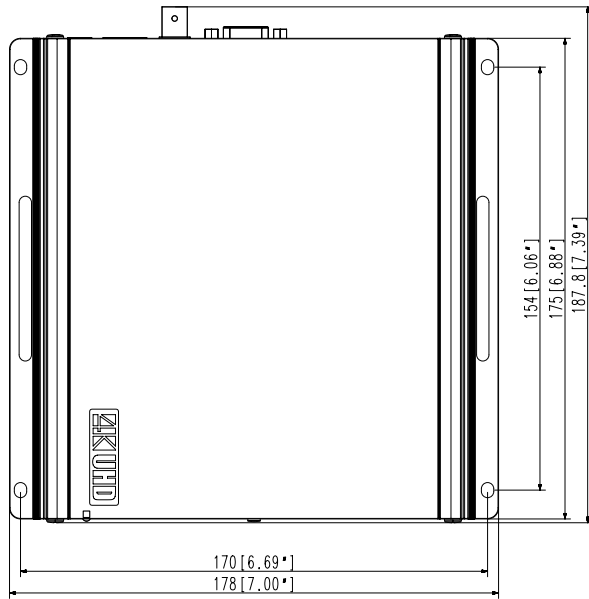
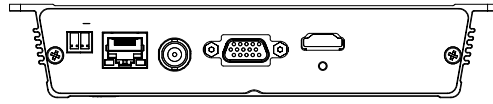

DEFAULT SETTING

To reset the system, move to "**System Management > Settings > Load Factory Default**" and press the **<Initialization>** button.

This returns the factory default settings.

- 
 When you initialize with the **<Authority Management Settings>** included, you are required to reboot the camera and reset the password.
- The initial administrator ID is "**admin**" and the password should be set when logging in for the first time.
- Please change your password every three months to safely protect personal information and to prevent the damage of the information theft. Please, take note that it's a user's responsibility for the security and any other problems caused by mismanaging a password.

Category	Details		Factory Default	
System	Date/Time/Language	System time	Date	YYYY-MM-DD
			Time	24 hours
			Time Zone	GMT
			Time Sync.	OFF
			DST	OFF
	User	Admin	Language	English
			ID	admin
			Permission Setup	Auto Log out
	System Management	System Information	Manual Input of ID	OFF
			Device Name	SPD-150
Log Information	System Log	Type	View all	
Device	Camera	Camera Register	OFF	
		Live Setup	OFF	
		Channel Setup	Video	ON
			Audio	OFF
	Camera Name		CAM 01 ~ CAM 64	
	Monitor	Monitor	Display	All
			Video Output	Clone
BNC Output			OFF	
Network	Interface	Network	IP Type	Static IP
			Network (Camera)	192.168.1.200
			Subnet Mask	255.255.255.0
			Gateway	192.168.1.1
			DNS	168.126.63.1

TROUBLESHOOTING

Problem	Action
Live video will be slow or cut off.	<ul style="list-style-type: none"> The frame number set for multiple data transmission set in camera or network environment could differ from the actual rate of transmission. Right click with the mouse button and select <Channel Information> to check the number of incoming frames for each channel and the actual number of framed played. Basically, when you register a camera, the Live4NVR profile is created and the rate is set to H.264.800*600fps. If you keep seeing video slow down or cut off, then check the network environment or camera condition.
The system does not turn on and the indicator on the front panel does not work at all.	<ul style="list-style-type: none"> Check if the power supply system is properly connected. Check the system for the input voltage from the power source. If the power is not turned on after the inspection processes above, check or replace the adapter.
Some channels display just a black screen even if they receive video sources.	<ul style="list-style-type: none"> Check if the camera is properly supplied with power. Check the video output connecting the camera's webviewer. Check if the network port is properly connected and the network setting is set correctly. Change the hub supporting Gigabit, it may solves.
The screen displays the logo image repeatedly.	<ul style="list-style-type: none"> This may occur from a problem with the main board, or the related software is corrupt. Contact the nearest service center for more information.
No video is played on the connected monitor.	<ul style="list-style-type: none"> Check if the necessary cables are connected to the monitor properly. Some monitors do not support the Decoder output (HDMI or VGA). (Output resolution : VGA : 1280*720, 1280*1024, 1920*1080, HDMI : 720P, 1080P, 1440P, 2160P) Check the monitor resolution In case of a 4K video, check whether the cable in use supports HDMI 2.0.
Camera cannot be connected.	<ul style="list-style-type: none"> Check if the network cable is connected properly. Check whether network - interface is set up. Check the IP settings of the camera. Try the Ping Test. Check if there is a different device near the product uses the same IP.

Problem	Action
The Live screen is too bright or too dark.	<ul style="list-style-type: none"> Check the video settings of the registered camera.
A message of "Need to reset date/time." Is displayed on the screen.	<ul style="list-style-type: none"> This message is displayed if there occurs a problem with the time setting of the internal clock or an error in the clock itself. Contact the retailer or the service center for more information.
I cannot see the result after connecting an external storage device (USB memory stick) to the decoder.	<ul style="list-style-type: none"> See the compatibility list of external storage devices to check if the connected device is supported by the Decoder. For the compatibility list, contact the retailer where you purchased the Decoder.
I forgot the password.	<ul style="list-style-type: none"> Press and hold the RESET button on the rear side at the right for 10 seconds. <ul style="list-style-type: none"> Please refer to No. 5 "Part Names and Functions (Rear)". (page 7)

OPEN SOURCE LICENSE REPORT ON THE PRODUCT

The software included in this product contains copyrighted software that is licensed under the GPL, LGPL, MPL 1.1, BSD 2-Clause License, BSD 3-Clause License, MIT License, libxml2 License, Apache 2.0 License, zlib/libpng License, Boost Software License, Curl License, Microsoft Public License, Code Project Open 1.02 License, JPEG License, RSA MD4 or MD5 Message-Digest Algorithm License, PHP License 3.01, OpenSSL Combined License, PCRE 5 License, NTP License, CodeIgniter License, GLUT for Win32 License, ISC License, Brian Gladman Alternate License. You may obtain the complete Corresponding Source code from us for a period of three years after our last shipment of this product by sending email to help.cctv@hanwha.com

If you want to obtain the complete Corresponding Source code in the physical medium such as CD-ROM, the cost of physically performing source distribution might be charged.

For more details about Open Source, refer to the CD or Hanwha Website.

- **GPL Software:** bonnie++ 1.03e, busybox 1.23.2, dibbler 0.8.4, Linux Kernel 3.10.y, ethtool-3.11, lsscsi-0.28, memtester 4.0.5, mii-tool-1.8.11, mtd-utils-1.5.1, smartmontools-6.4, udhcp-0.9.8, wpa-suplicant-0.7.3, xfsprogs-3.1.11, gdb-7.8.1, msmtmp-1.4.21, parted-3.1, wget-1.14
- **LGPL Software:** ffmpeg-2.4.3, glibc 2.16, Live555, Qt 4.7.2
- **MPL 1.1:** npapi-sdk
- **BSD 2-Clause License:** FreeBSD
- **BSD 3-Clause License:** miniuipnc-1.5-ppc, net-snmp-5.6.2.1, ppp-2.4.5, jquery.sha256, jsbn, libjpeg-turbo, lighttpd, msinttypes, requires, spherical++, sprintf 0.7, System-Verilog-Packet-Library, Text OpenGL Extension Wrangler Library 1.7.0
- **MIT License:** aptechcmsv2, avropendous, cJSON, cJSON-Dave Gamble, dynatree, javascript-ipv6, jqGrid, jQuery UI, jquery-form, jquery-hashchange, jquery-json, jquery-numeric, jquery-throttle-debounce 1.1, JS-Browser-Driver, moon9, noty, Raphael JavaScript Library, wildflower 1.3.Beta
- **libxml2 License:** libxml2 2.7.7
- **Apache 2.0 License:** RLLib
- **zlib/libpng License:** cximage, HM NIS Edit, Nullsoft Scriptable Install System 2.46, PNG reference library, tinyxml 2.6.2, zlib
- **Boost Software License:** boost 1.57.0
- **Curl License:** curl 7.47.0
- **Microsoft Public License:** Minima, Text Designer Outline Text Library
- **Code Project Open 1.02 License:** CPPSQLite - C++ Wrapper for SQLite, A reusable, high performance, socket server class - Part3
- **JPEG License:** libjpeg-8b
- **RSA MD4 or MD5 Message-Digest Algorithm License:** JavaScript MD5 1.1, sipxtapi
- **PHP License 3.01:** HPHP-2.1.0, PHP 5.6.14
- **OpenSSL Combined License:** OpenSSL 1.0.2k
- **PCRE 5 License:** pcre 8.31
- **NTP License:** ntp 4.2.8p4
- **CodeIgniter License:** CodeIgniter
- **GLUT for Win32 License:** GLUT for Win32
- **ISC License:** dhcp 4.3-2rc2
- **Brian Gladman Alternate License:** AES with the VIA ACE
- **Acknowledgement:** This product includes modified version of ffmpeg, Live555, Qt 4.7.2, and npapi-sdk.

GNU General Public License (GPL)

Version 2, June 1991

Copyright (C) 1989, 1991 Free Software Foundation, Inc.

59 Temple Place, Suite 330, Boston, MA 02111-1307 USA

Everyone is permitted to copy and distribute verbatim copies of this license document, but changing it is not allowed.

Preamble

The licenses for most software are designed to take away your freedom to share and change it. By contrast, the GNU General Public License is intended to guarantee your freedom to share and change free software--to make sure the software is free for all its users. This General Public License applies to most of the Free Software Foundation's software and to any other program whose authors commit to using it. (Some other Free Software Foundation software is covered by the GNU Library General Public License instead.) You can apply it to your programs, too.

When we speak of free software, we are referring to freedom, not price. Our General Public Licenses are designed to make sure that you have the freedom to distribute copies of free software (and charge for this service if you wish), that you receive source code or can get it if you want it, that you can change the software or use pieces of it in new free programs; and that you know you can do these things.

To protect your rights, we need to make restrictions that forbid anyone to deny you these rights or to ask you to surrender the rights. These restrictions translate to certain responsibilities for you if you distribute copies of the software, or if you modify it.

For example, if you distribute copies of such a program, whether gratis or for a fee, you must give the recipients all the rights that you have. You must make sure that they, too, receive or can get the source code. And you must show them these terms so they know their rights.

We protect your rights with two steps: (1) copyright the software, and (2) offer you this license which gives you legal permission to copy, distribute and/or modify the software.

Also, for each author's protection and ours, we want to make certain that everyone understands that there is no warranty for this free software. If the software is modified by someone else and passed on, we want its recipients to know that what they have is not the original, so that any problems introduced by others will not reflect on the original authors' reputations.

Finally, any free program is threatened constantly by software patents. We wish to avoid the danger that redistributors of a free program will individually obtain patent licenses, in effect making the program proprietary. To prevent this, we have made it clear that any patent must be licensed for everyone's free use or not licensed at all.

The precise terms and conditions for copying, distribution and modification follow.

TERMS AND CONDITIONS FOR COPYING, DISTRIBUTION AND MODIFICATION

0. This License applies to any program or other work which contains a notice placed by the copyright holder saying it may be distributed under the terms of this General Public License. The "Program", below, refers to any such program or work, and a "work based on the Program" means either the Program or any derivative work under copyright law: that is to

say, a work containing the Program or a portion of it, either verbatim or with modifications and/or translated into another language. (Hereinafter, translation is included without limitation in the term "modification".) Each licensee is addressed as "you".

Activities other than copying, distribution and modification are not covered by this License; they are outside its scope. The act of running the Program is not restricted, and the output from the Program is covered only if its contents constitute a work based on the Program (independent of having been made by running the Program). Whether that is true depends on what the Program does.

1. You may copy and distribute verbatim copies of the Program's source code as you receive it, in any medium, provided that you conspicuously and appropriately publish on each copy an appropriate copyright notice and disclaimer of warranty; keep intact all the notices that refer to this License and to the absence of any warranty; and give any other recipients of the Program a copy of this License along with the Program.

You may charge a fee for the physical act of transferring a copy, and you may at your option offer warranty protection in exchange for a fee.

2. You may modify your copy or copies of the Program or any portion of it, thus forming a work based on the Program, and copy and distribute such modifications or work under the terms of Section 1 above, provided that you also meet all of these conditions:

a) You must cause the modified files to carry prominent notices stating that you changed the files and the date of any change.

b) You must cause any work that you distribute or publish, that in whole or in part contains or is derived from the Program or any part thereof, to be licensed as a whole at no charge to all third parties under the terms of this License.

c) If the modified program normally reads commands interactively when run, you must cause it, when started running for such interactive use in the most ordinary way, to print or display an announcement including an appropriate copyright notice and a notice that there is no warranty (or else, saying that you provide a warranty) and that users may redistribute the program under these conditions, and telling the user how to view a copy of this License. (Exception: if the Program itself is interactive but does not normally print such an announcement, your work based on the Program is not required to print an announcement.)

These requirements apply to the modified work as a whole. If identifiable sections of that work are not derived from the Program, and can be reasonably considered independent and separate works in themselves, then this License, and its terms, do not apply to those sections when you distribute them as separate works. But when you distribute the same sections as part of a whole which is a work based on the Program, the distribution of the whole must be on the terms of this License, whose permissions for other licensees extend to the entire whole, and thus to each and every part regardless of who wrote it.

Thus, it is not the intent of this section to claim rights or contest your rights to work written entirely by you; rather, the intent is to exercise the right to control the distribution of derivative or collective works based on the Program.

In addition, mere aggregation of another work not based on the Program with the Program (or with a work based on the Program) on a volume of a storage or distribution medium does not bring the other work under the scope of this License.

3. You may copy and distribute the Program (or a work based on it, under Section 2) in object code or executable form under the terms of Sections 1 and 2 above provided that you also do one of the following:

a) Accompany it with the complete corresponding machine-readable source code, which must be distributed under the terms of Sections 1 and 2 above on a medium customarily used for software interchange; or,

b) Accompany it with a written offer, valid for at least three years, to give any third party, for a charge no more than your cost of physically performing source distribution, a complete machine-readable copy of the corresponding source code, to be distributed under the terms of Sections 1 and 2 above on a medium customarily used for software interchange; or,

c) Accompany it with the information you received as to the offer to distribute corresponding source code. (This alternative is allowed only for noncommercial distribution and only if you received the program in object code or executable form with such an offer, in accord with Subsection b above.)

The source code for a work means the preferred form of the work for making modifications to it. For an executable work, complete source code means all the source code for all modules it contains, plus any associated interface definition files, plus the scripts used to control compilation and installation of the executable. However, as a special exception, the source code distributed need not include anything that is normally distributed (in either source or binary form) with the major components (compiler, kernel, and so on) of the operating system on which the executable runs, unless that component itself accompanies the executable.

If distribution of executable or object code is made by offering access to copy from a designated place, then offering equivalent access to copy the source code from the same place counts as distribution of the source code, even though third parties are not compelled to copy the source along with the object code.

4. You may not copy, modify, sublicense, or distribute the Program except as expressly provided under this License. Any attempt otherwise to copy, modify, sublicense or distribute the Program is void, and will automatically terminate your rights under this License. However, parties who have received copies, or rights, from you under this License will not have their licenses terminated so long as such parties remain in full compliance.

5. You are not required to accept this License, since you have not signed it. However, nothing else grants you permission to modify or distribute the Program or its derivative works. These actions are prohibited by law if you do not accept this License. Therefore, by modifying or distributing the Program (or any work based on the Program), you indicate your acceptance of this License to do so, and all its terms and conditions for copying, distributing or modifying the Program or works based on it.

6. Each time you redistribute the Program (or any work based on the Program), the recipient automatically receives a license from the original licensor to copy, distribute or modify the Program subject to these terms and conditions. You may not impose any further restrictions on the recipients' exercise of the rights granted herein. You are not responsible for enforcing compliance by third parties to this License.

7. If, as a consequence of a court judgment or allegation of patent infringement or for any other reason (not limited to patent issues), conditions are imposed on you (whether by court order, agreement or otherwise) that contradict the conditions of this License, they do not excuse you from the conditions of this License. If you cannot distribute so as to satisfy simultaneously your obligations under this License and any other pertinent obligations, then as a consequence you may not distribute the Program at all. For example, if a patent license would not permit royalty-free redistribution of the Program by all those who receive copies directly or indirectly through you, then the only way you could satisfy both it and this License would be to refrain entirely from distribution of the Program.

If any portion of this section is held invalid or unenforceable under any particular circumstance, the balance of the section is intended to apply and the section as a whole is intended to apply in other circumstances.

It is not the purpose of this section to induce you to infringe any patents or other property right claims or to contest validity of any such claims; this section has the sole purpose of protecting the integrity of the free software distribution system, which is implemented by public license practices. Many people have made generous contributions to the wide range of software distributed through that system in reliance on consistent application of that system; it is up to the author/donor to decide if he or she is willing to distribute software through any other system and a licensee cannot impose that choice.

This section is intended to make thoroughly clear what is believed to be a consequence of the rest of this License.

8. If the distribution and/or use of the Program is restricted in certain countries either by patents or by copyrighted interfaces, the original copyright holder who places the Program under this License may add an explicit geographical distribution limitation excluding those countries, so that distribution is permitted only in or among countries not thus excluded. In such case, this License incorporates the limitation as if written in the body of this License.

9. The Free Software Foundation may publish revised and/or new versions of the General Public License from time to time. Such new versions will be similar in spirit to the present version, but may differ in detail to address new problems or concerns.

Each version is given a distinguishing version number. If the Program specifies a version number of this License which applies to it and "any later version", you have the option of following the terms and conditions either of that version or of any later version published by the Free

Software Foundation. If the Program does not specify a version number of this License, you may choose any version ever published by the Free Software Foundation.

10. If you wish to incorporate parts of the Program into other free programs whose distribution conditions are different, write to the author to ask for permission. For software which is copyrighted by the Free Software Foundation, write to the Free Software Foundation; we sometimes make exceptions for this. Our decision will be guided by the two goals of preserving the free status of all derivatives of our free software and of promoting the sharing and reuse of software generally.

NO WARRANTY

11. BECAUSE THE PROGRAM IS LICENSED FREE OF CHARGE, THERE IS NO WARRANTY FOR THE PROGRAM, TO THE EXTENT PERMITTED BY APPLICABLE LAW. EXCEPT WHEN OTHERWISE STATED IN WRITING THE COPYRIGHT HOLDERS AND/OR OTHER PARTIES PROVIDE THE PROGRAM "AS IS" WITHOUT WARRANTY OF ANY KIND, EITHER EXPRESSED OR IMPLIED, INCLUDING, BUT NOT LIMITED TO, THE IMPLIED WARRANTIES OF MERCHANTABILITY AND FITNESS FOR A PARTICULAR PURPOSE. THE ENTIRE RISK AS TO THE QUALITY AND PERFORMANCE OF THE PROGRAM IS WITH YOU. SHOULD THE PROGRAM PROVE DEFECTIVE, YOU ASSUME THE COST OF ALL NECESSARY SERVICING, REPAIR OR CORRECTION.

12. IN NO EVENT UNLESS REQUIRED BY APPLICABLE LAW OR AGREED TO IN WRITING WILL ANY COPYRIGHT HOLDER, OR ANY OTHER PARTY WHO MAY MODIFY AND/OR REDISTRIBUTE THE PROGRAM AS PERMITTED ABOVE, BE LIABLE TO YOU FOR DAMAGES, INCLUDING ANY GENERAL, SPECIAL, INCIDENTAL OR CONSEQUENTIAL DAMAGES ARISING OUT OF THE USE OR INABILITY TO USE THE PROGRAM (INCLUDING BUT NOT LIMITED TO LOSS OF DATA OR DATA BEING RENDERED INACCURATE OR LOSSES SUSTAINED BY YOU OR THIRD PARTIES OR A FAILURE OF THE PROGRAM TO OPERATE WITH ANY OTHER PROGRAMS), EVEN IF SUCH HOLDER OR OTHER PARTY HAS BEEN ADVISED OF THE POSSIBILITY OF SUCH DAMAGES.

END OF TERMS AND CONDITIONS

How to Apply These Terms to Your New Programs

If you develop a new program, and you want it to be of the greatest possible use to the public, the best way to achieve this is to make it free software which everyone can redistribute and change under these terms.

To do so, attach the following notices to the program. It is safest to attach them to the start of each source file to most effectively convey the exclusion of warranty; and each file should have at least the "copyright" line and a pointer to where the full notice is found.

one line to give the program's name and an idea of what it does.

Copyright (C) yyyy name of author

This program is free software; you can redistribute it and/or

modify it under the terms of the GNU General Public License

as published by the Free Software Foundation; either version 2

of the License, or (at your option) any later version.

This program is distributed in the hope that it will be useful,

but WITHOUT ANY WARRANTY; without even the implied warranty of MERCHANTABILITY or FITNESS FOR A PARTICULAR PURPOSE. See the

GNU General Public License for more details.

You should have received a copy of the GNU General Public License

along with this program; if not, write to the Free Software

Foundation, Inc., 51 Franklin Street, Fifth Floor, Boston, MA 02110-1301, USA.

Also add information on how to contact you by electronic and paper mail.

If the program is interactive, make it output a short notice like this when it starts in an interactive mode:

Gnomovision version 69, Copyright (C) year name of author

Gnomovision comes with ABSOLUTELY NO WARRANTY; for details

type `show w'. This is free software, and you are welcome

to redistribute it under certain conditions; type `show c'

for details.

The hypothetical commands `show w' and `show c' should show the appropriate parts of the General Public License. Of course, the

commands you use may be called something other than `show w' and `show c'; they could even be mouse-clicks or menu items--whatever suits your program.

You should also get your employer (if you work as a programmer) or your school, if any, to sign a "copyright disclaimer" for the program, if necessary. Here is a sample; alter the names:

Yoyodyne, Inc., hereby disclaims all copyright

interest in the program `Gnomovision'

(which makes passes at compilers) written

by James Hacker.

signature of Ty Coon, 1 April 1989

Ty Coon, President of Vice

This General Public License does not permit incorporating your program into proprietary programs. If your program is a subroutine library, you may consider it more useful to permit linking proprietary applications with the library. If this is what you want to do, use the GNU Lesser General Public License instead of this License.

GNU General Public License

Version 3, 29 June 2007

Copyright (C) 2007 Free Software Foundation, Inc. <<http://fsf.org/>>

Everyone is permitted to copy and distribute verbatim copies of this license document, but changing it is not allowed.

Preamble

The GNU General Public License is a free, copyleft license for software and other kinds of works.

The licenses for most software and other practical works are designed to take away your freedom to share and change the works. By contrast, the GNU General Public License is intended to guarantee your freedom to share and change all versions of a program--to make sure it remains free software for all its users. We, the Free Software Foundation, use the GNU General Public License for most of our software; it applies also to any other work released this way by its authors. You can apply it to your programs, too.

When we speak of free software, we are referring to freedom, not price. Our General Public Licenses are designed to make sure that you have the freedom to distribute copies of free software (and charge for them if you wish), that you receive source code or can get it if you want it, that you can change the software or use pieces of it in new free programs, and that you know you can do these things.

To protect your rights, we need to prevent others from denying you these rights or asking you to surrender the rights. Therefore, you have certain responsibilities if you distribute copies of the software, or if you modify it: responsibilities to respect the freedom of others.

For example, if you distribute copies of such a program, whether gratis or for a fee, you must pass on to the recipients the same freedoms that you received. You must make sure that they, too, receive or can get the source code. And you must show them these terms so they know their rights.

Developers that use the GNU GPL protect your rights with two steps: (1) assert copyright on the software, and (2) offer you this License giving you legal permission to copy, distribute and/or modify it.

For the developers' and authors' protection, the GPL clearly explains that there is no warranty for this free software. For both users' and authors' sake, the GPL requires that modified versions be marked as changed, so that their problems will not be attributed erroneously to authors of previous versions.

Some devices are designed to deny users access to install or run modified versions of the software inside them, although the manufacturer can do so. This is fundamentally incompatible with the aim of protecting users' freedom to change the software. The systematic pattern of such abuse occurs in the area of products for individuals to use, which is precisely where it is most unacceptable. Therefore, we have designed this version of the GPL to prohibit the practice for those products. If such problems arise substantially in other domains, we stand ready to extend this provision to those domains in future versions of the GPL, as needed to protect the freedom of users.

Finally, every program is threatened constantly by software patents. States should not allow patents to restrict development and use of software on general-purpose computers, but in those that do, we wish to avoid the special danger that patents applied to a free program could make it effectively proprietary. To prevent this, the GPL assures that patents cannot be used to render the program non-free.

The precise terms and conditions for copying, distribution and modification follow.

TERMS AND CONDITIONS

0. Definitions.

"This License" refers to version 3 of the GNU General Public License.

"Copyright" also means copyright-like laws that apply to other kinds of works, such as semiconductor masks.

"The Program" refers to any copyrightable work licensed under this License. Each licensee is addressed as "you". "Licensees" and "recipients" may be individuals or organizations.

To "modify" a work means to copy from or adapt all or part of the work in a fashion requiring copyright permission, other than the making of an exact copy. The resulting work is called a "modified version" of the earlier work or a work "based on" the earlier work.

A "covered work" means either the unmodified Program or a work based on the Program.

To "propagate" a work means to do anything with it that, without permission, would make you directly or secondarily liable for infringement under applicable copyright law, except executing it on a computer or modifying a private copy. Propagation includes copying, distribution (with or without modification), making available to the public, and in some countries other activities as well.

To "convey" a work means any kind of propagation that enables other parties to make or receive copies. Mere interaction with a user through a computer network, with no transfer of a copy, is not conveying.

An interactive user interface displays "Appropriate Legal Notices" to the extent that it includes a convenient and prominently visible feature that (1) displays an appropriate copyright notice, and (2) tells the user that there is no warranty for the work (except to the extent that warranties are provided), that licensees may convey the work under this License, and how to view a copy of this License. If the interface presents a list of user commands or options, such as a menu, a prominent item in the list meets this criterion.

1. Source Code.

The "source code" for a work means the preferred form of the work for making modifications to it. "Object code" means any non-source form of a work.

A "Standard Interface" means an interface that either is an official standard defined by a recognized standards body, or, in the case of interfaces specified for a particular programming language, one that is widely used among developers working in that language.

The "System Libraries" of an executable work include anything, other than the work as a whole, that (a) is included in the normal form of packaging a Major Component, but which is not part of that Major Component, and (b) serves only to enable use of the work with that Major Component, or to implement a Standard Interface for which an implementation is available to the public in source code form. A "Major Component", in this context, means a major essential component (kernel, window system, and so on) of the specific operating system (if any) on which the executable work runs, or a compiler used to produce the work, or an object code interpreter used to run it.

The "Corresponding Source" for a work in object code form means all the source code needed to generate, install, and (for an executable work) run the object code and to modify the work, including scripts to control those activities. However, it does not include the work's System Libraries, or general-purpose tools or generally available free programs which are used unmodified in performing those activities but which are not part of the work. For example, Corresponding Source includes interface definition files associated with source files for the work, and the source code for shared libraries and dynamically linked subprograms that the work is specifically designed to require, such as by intimate data communication or control flow between those subprograms and other parts of the work.

The Corresponding Source need not include anything that users can regenerate automatically from other parts of the Corresponding Source.

The Corresponding Source for a work in source code form is that same work.

2. Basic Permissions.

All rights granted under this License are granted for the term of copyright on the Program, and are irrevocable provided the stated conditions are met. This License explicitly affirms your unlimited permission to run the unmodified Program. The output from running a covered work is covered

by this License only if the output, given its content, constitutes a covered work. This License acknowledges your rights of fair use or other equivalent, as provided by copyright law.

You may make, run and propagate covered works that you do not convey, without conditions so long as your license otherwise remains in force. You may convey covered works to others for the sole purpose of having them make modifications exclusively for you, or provide you with facilities for running those works, provided that you comply with the terms of this License in conveying all material for which you do not control copyright. Those thus making or running the covered works for you must do so exclusively on your behalf, under your direction and control, on terms that prohibit them from making any copies of your copyrighted material outside their relationship with you.

Conveying under any other circumstances is permitted solely under the conditions stated below. Sublicensing is not allowed; section 10 makes it unnecessary.

3. Protecting Users' Legal Rights From Anti-Circumvention Law.

No covered work shall be deemed part of an effective technological measure under any applicable law fulfilling obligations under article 11 of the WIPO copyright treaty adopted on 20 December 1996, or similar laws prohibiting or restricting circumvention of such measures.

When you convey a covered work, you waive any legal power to forbid circumvention of technological measures to the extent such circumvention is effected by exercising rights under this License with respect to the covered work, and you disclaim any intention to limit operation or modification of the work as a means of enforcing, against the work's users, your or third parties' legal rights to forbid circumvention of technological measures.

4. Conveying Verbatim Copies.

You may convey verbatim copies of the Program's source code as you receive it, in any medium, provided that you conspicuously and appropriately publish on each copy an appropriate copyright notice; keep intact all notices stating that this License and any non-permissive terms added in accord with section 7 apply to the code; keep intact all notices of the absence of any warranty; and give all recipients a copy of this License along with the Program.

You may charge any price or no price for each copy that you convey, and you may offer support or warranty protection for a fee.

5. Conveying Modified Source Versions.

You may convey a work based on the Program, or the modifications to produce it from the Program, in the form of source code under the terms of section 4, provided that you also meet all of these conditions:

- The work must carry prominent notices stating that you modified it, and giving a relevant date.
- The work must carry prominent notices stating that it is released under this License and any conditions added under section 7. This requirement modifies the requirement in section 4 to "keep intact all notices".
- You must license the entire work, as a whole, under this License to anyone who comes into possession of a copy. This License will therefore apply, along with any applicable section 7 additional terms, to the whole of the work, and all its parts, regardless of how they are packaged. This License gives no permission to license the work in any other way, but it does not invalidate such permission if you have separately received it.
- If the work has interactive user interfaces, each must display Appropriate Legal Notices; however, if the Program has interactive interfaces that do not display Appropriate Legal Notices, your work need not make them do so.

A compilation of a covered work with other separate and independent works, which are not by their nature extensions of the covered work, and which are not combined with it such as to form a larger program, in or on a volume of a storage or distribution medium, is called an "aggregate" if the compilation and its resulting copyright are not used to limit the access or legal rights of the compilation's users beyond what the individual works permit. Inclusion of a covered work in an aggregate does not cause this License to apply to the other parts of the aggregate.

6. Conveying Non-Source Forms.

You may convey a covered work in object code form under the terms of sections 4 and 5, provided that you also convey the machine-readable Corresponding Source under the terms of this License, in one of these ways:

- Convey the object code in, or embodied in, a physical product (including a physical distribution medium), accompanied by the Corresponding Source fixed on a durable physical medium customarily used for software interchange.

b) Convey the object code in, or embodied in, a physical product (including a physical distribution medium), accompanied by a written offer, valid for at least three years and valid for as long as you offer spare parts or customer support for that product model, to give anyone who possesses the object code either (1) a copy of the Corresponding Source for all the software in the product that is covered by this License, on a durable physical medium customarily used for software interchange, for a price no more than your reasonable cost of physically performing this conveying of source, or (2) access to copy the Corresponding Source from a network server at no charge.

c) Convey individual copies of the object code with a copy of the written offer to provide the Corresponding Source. This alternative is allowed only occasionally and noncommercially, and only if you received the object code with such an offer, in accord with subsection 6b.

d) Convey the object code by offering access from a designated place (gratis or for a charge), and offer equivalent access to the Corresponding Source in the same way through the same place at no further charge. You need not require recipients to copy the Corresponding Source along with the object code. If the place to copy the object code is a network server, the Corresponding Source may be on a different server (operated by you or a third party) that supports equivalent copying facilities, provided you maintain clear directions next to the object code saying where to find the Corresponding Source. Regardless of what server hosts the Corresponding Source, you remain obligated to ensure that it is available for as long as needed to satisfy these requirements.

e) Convey the object code using peer-to-peer transmission, provided you inform other peers where the object code and Corresponding Source of the work are being offered to the general public at no charge under subsection 6d.

A separable portion of the object code, whose source code is excluded from the Corresponding Source as a System Library, need not be included in conveying the object code work.

A “User Product” is either (1) a “consumer product”, which means any tangible personal property which is normally used for personal, family, or household purposes, or (2) anything designed or sold for incorporation into a dwelling. In determining whether a product is a consumer product, doubtful cases shall be resolved in favor of coverage. For a particular product received by a particular user, “normally used” refers to a typical or common use of that class of product, regardless of the status of the particular user or of the way in which the particular user actually uses, or expects or is expected to use, the product. A product is a consumer product regardless of whether the product has substantial commercial, industrial or non-consumer uses, unless such uses represent the only significant mode of use of the product.

“Installation Information” for a User Product means any methods, procedures, authorization keys, or other information required to install and execute modified versions of a covered work in that User Product from a modified version of its Corresponding Source. The information must suffice to ensure that the continued functioning of the modified object code is in no case prevented or interfered with solely because modification has been made.

If you convey an object code work under this section in, or with, or specifically for use in, a User Product, and the conveying occurs as part of a transaction in which the right of possession and use of the User Product is transferred to the recipient in perpetuity or for a fixed term (regardless of how the transaction is characterized), the Corresponding Source conveyed under this section must be accompanied by the Installation Information. But this requirement does not apply if neither you nor any third party retains the ability to install modified object code on the User Product (for example, the work has been installed in ROM).

The requirement to provide Installation Information does not include a requirement to continue to provide support service, warranty, or updates for a work that has been modified or installed by the recipient, or for the User Product in which it has been modified or installed. Access to a network may be denied when the modification itself materially and adversely affects the operation of the network or violates the rules and protocols for communication across the network.

Corresponding Source conveyed, and Installation Information provided, in accord with this section must be in a format that is publicly documented (and with an implementation available to the public in source code form), and must require no special password or key for unpacking, reading or copying.

7. Additional Terms.

“Additional permissions” are terms that supplement the terms of this License by making exceptions from one or more of its conditions.

Additional permissions that are applicable to the entire Program shall be treated as though they were included in this License, to the extent that they are valid under applicable law. If additional permissions apply only to part of the Program, that part may be used separately under those permissions, but the entire Program remains governed by this License without regard to the additional permissions.

When you convey a copy of a covered work, you may at your option remove any additional permissions from that copy, or from any part of it. (Additional permissions may be written to require their own removal in certain cases when you modify the work.) You may place additional permissions on material, added by you to a covered work, for which you have or can give appropriate copyright permission.

Notwithstanding any other provision of this License, for material you add to a covered work, you may (if authorized by the copyright holders of that material) supplement the terms of this License with terms:

a) Disclaiming warranty or limiting liability differently from the terms of sections 15 and 16 of this License; or

b) Requiring preservation of specified reasonable legal notices or author attributions in that material or in the Appropriate Legal Notices displayed by works containing it; or

c) Prohibiting misrepresentation of the origin of that material, or requiring that modified versions of such material be marked in reasonable ways as different from the original version; or

d) Limiting the use for publicity purposes of names of licensors or authors of the material; or

e) Declining to grant rights under trademark law for use of some trade names, trademarks, or service marks; or

f) Requiring indemnification of licensors and authors of that material by anyone who conveys the material (or modified versions of it) with contractual assumptions of liability to the recipient, for any liability that these contractual assumptions directly impose on those licensors and authors.

All other non-permissive additional terms are considered “further restrictions” within the meaning of section 10. If the Program as you received it, or any part of it, contains a notice stating that it is governed by this License along with a term that is a further restriction, you may remove that term. If a license document contains a further restriction but permits relicensing or conveying under this License, you may add to a covered work material governed by the terms of that license document, provided that the further restriction does not survive such relicensing or conveying.

If you add terms to a covered work in accord with this section, you must place, in the relevant source files, a statement of the additional terms that apply to those files, or a notice indicating where to find the applicable terms.

Additional terms, permissive or non-permissive, may be stated in the form of a separately written license, or stated as exceptions; the above requirements apply either way.

8. Termination.

You may not propagate or modify a covered work except as expressly provided under this License. Any attempt otherwise to propagate or modify it is void, and will automatically terminate your rights under this License (including any patent licenses granted under the third paragraph of section 11).

However, if you cease all violation of this License, then your license from a particular copyright holder is reinstated (a) provisionally, unless and until the copyright holder explicitly and finally terminates your license, and (b) permanently, if the copyright holder fails to notify you of the violation by some reasonable means prior to 60 days after the cessation.

Moreover, your license from a particular copyright holder is reinstated permanently if the copyright holder notifies you of the violation by some reasonable means, this is the first time you have received notice of violation of this License (for any work) from that copyright holder, and you cure the violation prior to 30 days after your receipt of the notice.

Termination of your rights under this section does not terminate the licenses of parties who have received copies or rights from you under this License. If your rights have been terminated and not permanently reinstated, you do not qualify to receive new licenses for the same material under section 10.

9. Acceptance Not Required for Having Copies.

You are not required to accept this License in order to receive or run a copy of the Program. Ancillary propagation of a covered work occurring solely as a consequence of using peer-to-peer transmission to receive a copy likewise does not require acceptance. However, nothing other than this License grants you permission to propagate or modify any covered

work. These actions infringe copyright if you do not accept this License. Therefore, by modifying or propagating a covered work, you indicate your acceptance of this License to do so.

10. Automatic Licensing of Downstream Recipients.

Each time you convey a covered work, the recipient automatically receives a license from the original licensors, to run, modify and propagate that work, subject to this License. You are not responsible for enforcing compliance by third parties with this License.

An “entity transaction” is a transaction transferring control of an organization, or substantially all assets of one, or subdividing an organization, or merging organizations. If propagation of a covered work results from an entity transaction, each party to that transaction who receives a copy of the work also receives whatever licenses to the work the party’s predecessor in interest had or could give under the previous paragraph, plus a right to possession of the Corresponding Source of the work from the predecessor in interest, if the predecessor has it or can get it with reasonable efforts.

You may not impose any further restrictions on the exercise of the rights granted or affirmed under this License. For example, you may not impose a license fee, royalty, or other charge for exercise of rights granted under this License, and you may not initiate litigation (including a cross-claim or counterclaim in a lawsuit) alleging that any patent claim is infringed by making, using, selling, offering for sale, or importing the Program or any portion of it.

11. Patents.

A “contributor” is a copyright holder who authorizes use under this License of the Program or a work on which the Program is based. The work thus licensed is called the contributor’s “contributor version”.

A contributor’s “essential patent claims” are all patent claims owned or controlled by the contributor, whether already acquired or hereafter acquired, that would be infringed by some manner, permitted by this License, of making, using, or selling its contributor version, but do not include claims that would be infringed only as a consequence of further modification of the contributor version. For purposes of this definition, “control” includes the right to grant patent sublicenses in a manner consistent with the requirements of this License.

Each contributor grants you a non-exclusive, worldwide, royalty-free patent license under the contributor’s essential patent claims, to make, use, sell, offer for sale, import and otherwise run, modify and propagate the contents of its contributor version.

In the following three paragraphs, a “patent license” is any express agreement or commitment, however denominated, not to enforce a patent (such as an express permission to practice a patent or covenant not to sue for patent infringement). To “grant” such a patent license to a party means to make such an agreement or commitment not to enforce a patent against the party.

If you convey a covered work, knowingly relying on a patent license, and the Corresponding Source of the work is not available for anyone to copy, free of charge and under the terms of this License, through a publicly available network server or other readily accessible means, then you must either (1) cause the Corresponding Source to be so available, or (2) arrange to deprive yourself of the benefit of the patent license for this particular work, or (3) arrange, in a manner consistent with the requirements of this License, to extend the patent license to downstream recipients. “Knowingly relying” means you have actual knowledge that, but for the patent license, your conveying the covered work in a country, or your recipient’s use of the covered work in a country, would infringe one or more identifiable patents in that country that you have reason to believe are valid.

If, pursuant to or in connection with a single transaction or arrangement, you convey, or propagate by procuring conveyance of, a covered work, and grant a patent license to some of the parties receiving the covered work authorizing them to use, propagate, modify or convey a specific copy of the covered work, then the patent license you grant is automatically extended to all recipients of the covered work and works based on it.

A patent license is “discriminatory” if it does not include within the scope of its coverage, prohibits the exercise of, or is conditioned on the non-exercise of one or more of the rights that are specifically granted under this License. You may not convey a covered work if you are a party to an arrangement with a third party that is in the business of distributing software, under which you make payment to the third party based on the extent of your activity of conveying the work, and under which the third party grants, to any of the parties who would receive the covered work from you, a discriminatory patent license (a) in connection with copies of the covered work conveyed by you (or copies made from those copies), or (b) primarily for and in connection with specific products or

compilations that contain the covered work, unless you entered into that arrangement, or that patent license was granted, prior to 28 March 2007.

Nothing in this License shall be construed as excluding or limiting any implied license or other defenses to infringement that may otherwise be available to you under applicable patent law.

12. No Surrender of Others’ Freedom.

If conditions are imposed on you (whether by court order, agreement or otherwise) that contradict the conditions of this License, they do not excuse you from the conditions of this License. If you cannot convey a covered work so as to satisfy simultaneously your obligations under this License and any other pertinent obligations, then as a consequence you may not convey it at all. For example, if you agree to terms that obligate you to collect a royalty for further conveying from those to whom you convey the Program, the only way you could satisfy both those terms and this License would be to refrain entirely from conveying the Program.

13. Use with the GNU Affero General Public License.

Notwithstanding any other provision of this License, you have permission to link or combine any covered work with a work licensed under version 3 of the GNU Affero General Public License into a single combined work, and to convey the resulting work. The terms of this License will continue to apply to the part which is the covered work, but the special requirements of the GNU Affero General Public License, section 13, concerning interaction through a network will apply to the combination as such.

14. Revised Versions of this License.

The Free Software Foundation may publish revised and/or new versions of the GNU General Public License from time to time. Such new versions will be similar in spirit to the present version, but may differ in detail to address new problems or concerns.

Each version is given a distinguishing version number. If the Program specifies that a certain numbered version of the GNU General Public License “or any later version” applies to it, you have the option of following the terms and conditions either of that numbered version or of any later version published by the Free Software Foundation. If the Program does not specify a version number of the GNU General Public License, you may choose any version ever published by the Free Software Foundation.

If the Program specifies that a proxy can decide which future versions of the GNU General Public License can be used, that proxy’s public statement of acceptance of a version permanently authorizes you to choose that version for the Program.

Later license versions may give you additional or different permissions. However, no additional obligations are imposed on any author or copyright holder as a result of your choosing to follow a later version.

15. Disclaimer of Warranty.

THERE IS NO WARRANTY FOR THE PROGRAM, TO THE EXTENT PERMITTED BY APPLICABLE LAW. EXCEPT WHEN OTHERWISE STATED IN WRITING THE COPYRIGHT HOLDERS AND/OR OTHER PARTIES PROVIDE THE PROGRAM “AS IS” WITHOUT WARRANTY OF ANY KIND, EITHER EXPRESSED OR IMPLIED, INCLUDING, BUT NOT LIMITED TO, THE IMPLIED WARRANTIES OF MERCHANTABILITY AND FITNESS FOR A PARTICULAR PURPOSE. THE ENTIRE RISK AS TO THE QUALITY AND PERFORMANCE OF THE PROGRAM IS WITH YOU. SHOULD THE PROGRAM PROVE DEFECTIVE, YOU ASSUME THE COST OF ALL NECESSARY SERVICING, REPAIR OR CORRECTION.

16. Limitation of Liability.

IN NO EVENT UNLESS REQUIRED BY APPLICABLE LAW OR AGREED TO IN WRITING WILL ANY COPYRIGHT HOLDER, OR ANY OTHER PARTY WHO MODIFIES AND/OR CONVEYS THE PROGRAM AS PERMITTED ABOVE, BE LIABLE TO YOU FOR DAMAGES, INCLUDING ANY GENERAL, SPECIAL, INCIDENTAL OR CONSEQUENTIAL DAMAGES ARISING OUT OF THE USE OR INABILITY TO USE THE PROGRAM (INCLUDING BUT NOT LIMITED TO LOSS OF DATA OR DATA BEING RENDERED INACCURATE OR LOSSES SUSTAINED BY YOU OR THIRD PARTIES OR A FAILURE OF THE PROGRAM TO OPERATE WITH ANY OTHER PROGRAMS), EVEN IF SUCH HOLDER OR OTHER PARTY HAS BEEN ADVISED OF THE POSSIBILITY OF SUCH DAMAGES.

17. Interpretation of Sections 15 and 16.

If the disclaimer of warranty and limitation of liability provided above cannot be given local legal effect according to their terms, reviewing courts shall apply local law that most closely approximates an absolute waiver of all civil liability in connection with the Program, unless a warranty or assumption of liability accompanies a copy of the Program in return for a fee.

END OF TERMS AND CONDITIONS

How to Apply These Terms to Your New Programs

If you develop a new program, and you want it to be of the greatest possible use to the public, the best way to achieve this is to make it free software which everyone can redistribute and change under these terms.

To do so, attach the following notices to the program. It is safest to attach them to the start of each source file to most effectively state the exclusion of warranty; and each file should have at least the “copyright” line and a pointer to where the full notice is found.

```
<one line to give the program's name and a brief idea of what it does.>
```

```
Copyright (C) <year> <name of author>
```

This program is free software: you can redistribute it and/or modify it under the terms of the GNU General Public License as published by the Free Software Foundation, either version 3 of the License, or (at your option) any later version.

This program is distributed in the hope that it will be useful, but WITHOUT ANY WARRANTY; without even the implied warranty of MERCHANTABILITY or FITNESS FOR A PARTICULAR PURPOSE. See the GNU General Public License for more details.

You should have received a copy of the GNU General Public License along with this program. If not, see <<http://www.gnu.org/licenses/>>.

Also add information on how to contact you by electronic and paper mail.

If the program does terminal interaction, make it output a short notice like this when it starts in an interactive mode:

```
<program> Copyright (C) <year> <name of author>
```

```
This program comes with ABSOLUTELY NO WARRANTY; for details
type `show w`.
```

```
This is free software, and you are welcome to redistribute it under
certain conditions; type `show c` for details.
```

The hypothetical commands `show w` and `show c` should show the appropriate parts of the General Public License. Of course, your program's commands might be different; for a GUI interface, you would use an “about box”.

You should also get your employer (if you work as a programmer) or school, if any, to sign a “copyright disclaimer” for the program, if necessary. For more information on this, and how to apply and follow the GNU GPL, see <<http://www.gnu.org/licenses/>>.

The GNU General Public License does not permit incorporating your program into proprietary programs. If your program is a subroutine library, you may consider it more useful to permit linking proprietary applications with the library. If this is what you want to do, use the GNU Lesser General Public License instead of this License. But first, please read <<http://www.gnu.org/philosophy/why-not-lgpl.html>>.

GNU Lesser General Public License

Version 2.1, February 1999

Copyright (C) 1991, 1999 Free Software Foundation, Inc.

59 Temple Place, Suite 330, Boston, MA 02111-1307 USA

Everyone is permitted to copy and distribute verbatim copies

of this license document, but changing it is not allowed.

[This is the first released version of the Lesser GPL. It also counts as the successor of the GNU Library Public License, version 2, hence the version number 2.1.]

Preamble

The licenses for most software are designed to take away your freedom to share and change it. By contrast, the GNU General Public Licenses are intended to guarantee your freedom to share and change free software--to make sure the software is free for all its users.

This license, the Lesser General Public License, applies to some specially designated software packages--typically libraries--of the Free Software Foundation and other authors who decide to use it. You can use it too, but we suggest you first think carefully about whether this license or the ordinary General Public License is the better strategy to use in any particular case, based on the explanations below.

When we speak of free software, we are referring to freedom of use, not price. Our General Public Licenses are designed to make sure that you have the freedom to distribute copies of free software (and charge for this service if you wish); that you receive source code or can get it if you want it; that you can change the software and use pieces of it in new free programs; and that you are informed that you can do these things.

To protect your rights, we need to make restrictions that forbid distributors to deny you these rights or to ask you to surrender these rights. These restrictions translate to certain responsibilities for you if you distribute copies of the library or if you modify it.

For example, if you distribute copies of the library, whether gratis or for a fee, you must give the recipients all the rights that we gave you. You must make sure that they, too, receive or can get the source code. If you link other code with the library, you must provide complete object files to the recipients, so that they can relink them with the library after making changes to the library and recompiling it. And you must show them these terms so they know their rights.

We protect your rights with a two-step method: (1) we copyright the library, and (2) we offer you this license, which gives you legal permission to copy, distribute and/or modify the library.

To protect each distributor, we want to make it very clear that there is no warranty for the free library. Also, if the library is modified by someone else and passed on, the recipients should know that what they have is not the original version, so that the original author's reputation will not be affected by problems that might be introduced by others.

Finally, software patents pose a constant threat to the existence of any free program. We wish to make sure that a company cannot effectively restrict the users of a free program by obtaining a restrictive license from a patent holder. Therefore, we insist that any patent license obtained for a version of the library must be consistent with the full freedom of use specified in this license.

Most GNU software, including some libraries, is covered by the ordinary GNU General Public License. This license, the GNU Lesser General Public License, applies to certain designated libraries, and is quite different from the ordinary General Public License. We use this license for certain libraries in order to permit linking those libraries into non-free programs.

When a program is linked with a library, whether statically or using a shared library, the combination of the two is legally speaking a combined work, a derivative of the original library. The ordinary General Public License therefore permits such linking only if the entire combination fits its criteria of freedom. The Lesser General Public License permits more lax criteria for linking other code with the library.

We call this license the "Lesser" General Public License because it does Less to protect the user's freedom than the ordinary General Public License. It also provides other free software developers Less of an advantage over competing non-free programs. These disadvantages are the reason we use the ordinary General Public License for many libraries. However, the Lesser license provides advantages in certain special circumstances.

For example, on rare occasions, there may be a special need to encourage the widest possible use of a certain library, so that it becomes a de-facto standard. To achieve this, non-free programs must be allowed to use the library. A more frequent case is that a free library does the same job as widely used non-free libraries. In this case, there is little to gain by limiting the free library to free software only, so we use the Lesser General Public License.

In other cases, permission to use a particular library in non-free programs enables a greater number of people to use a large body of free software. For example, permission to use the GNU C Library in non-free programs enables many more people to use the whole GNU operating system, as well as its variant, the GNU/Linux operating system.

Although the Lesser General Public License is Less protective of the users' freedom, it does ensure that the user of a program that is linked with the Library has the freedom and the wherewithal to run that program using a modified version of the Library.

The precise terms and conditions for copying, distribution and modification follow. Pay close attention to the difference between a "work based on the library" and a "work that uses the library". The former contains code derived from the library, whereas the latter must be combined with the library in order to run.

TERMS AND CONDITIONS FOR COPYING, DISTRIBUTION AND MODIFICATION

0. This License Agreement applies to any software library or other program which contains a notice placed by the copyright holder or other authorized party saying it may be distributed under the terms of this Lesser General Public License (also called "this License"). Each licensee is addressed as "you".

A "library" means a collection of software functions and/or data prepared so as to be conveniently linked with application programs (which use some of those functions and data) to form executables.

The "Library", below, refers to any such software library or work which has been distributed under these terms. A "work based on the Library" means either the Library or any derivative work under copyright law: that is to say, a work containing the Library or a portion of it, either verbatim or with modifications and/or translated straightforwardly into another language. (Hereinafter, translation is included without limitation in the term "modification".)

"Source code" for a work means the preferred form of the work for making modifications to it. For a library, complete source code means all the source code for all modules it contains, plus any associated interface definition files, plus the scripts used to control compilation and installation of the library.

Activities other than copying, distribution and modification are not covered by this License; they are outside its scope. The act of running a program using the Library is not restricted, and output from such a program is covered only if its contents constitute a work based on the Library (independent of the use of the Library in a tool for writing it). Whether that is true depends on what the Library does and what the program that uses the Library does.

1. You may copy and distribute verbatim copies of the Library's complete source code as you receive it, in any medium, provided that you conspicuously and appropriately publish on each copy an appropriate copyright notice and disclaimer of warranty; keep intact all the notices that refer to this License and to the absence of any warranty; and distribute a copy of this License along with the Library.

You may charge a fee for the physical act of transferring a copy, and you may at your option offer warranty protection in exchange for a fee.

2. You may modify your copy or copies of the Library or any portion of it, thus forming a work based on the Library, and copy and distribute such modifications or work under the terms of Section 1 above, provided that you also meet all of these conditions:

- The modified work must itself be a software library.
- You must cause the files modified to carry prominent notices stating that you changed the files and the date of any change.
- You must cause the whole of the work to be licensed at no charge to all third parties under the terms of this License.
- If a facility in the modified Library refers to a function or a table of data to be supplied by an application program that uses the facility, other than as an argument passed when the facility is invoked, then you must make a good faith effort to ensure that, in the event an application does not supply such function or table, the facility still operates, and performs whatever part of its purpose remains meaningful.

(For example, a function in a library to compute square roots has a purpose that is entirely well-defined independent of the application. Therefore, Subsection 2d requires that any application-supplied function or table used by this function must be optional: if the application does not supply it, the square root function must still compute square roots.)

These requirements apply to the modified work as a whole. If identifiable sections of that work are not derived from the Library, and can be reasonably considered independent and separate works in themselves, then this License, and its terms, do not apply to those sections when you distribute them as separate works. But when you distribute the same sections as part of a whole which is a work based on the Library, the distribution of the whole must be on the terms of this License, whose permissions for other licensees extend to the entire whole, and thus to each and every part regardless of who wrote it.

Thus, it is not the intent of this section to claim rights or contest your rights to work written entirely by you; rather, the intent is to exercise the right to control the distribution of derivative or collective works based on the Library.

In addition, mere aggregation of another work not based on the Library with the Library (or with a work based on the Library) on a volume of a storage or distribution medium does not bring the other work under the scope of this License.

3. You may opt to apply the terms of the ordinary GNU General Public License instead of this License to a given copy of the Library. To do this, you must alter all the notices that refer to this License, so that they refer to the ordinary GNU General Public License, version 2, instead of to this License. (If a newer version than version 2 of the ordinary GNU General Public License has appeared, then you can specify that version instead if you wish.) Do not make any other change in these notices.

Once this change is made in a given copy, it is irreversible for that copy, so the ordinary GNU General Public License applies to all subsequent copies and derivative works made from that copy.

This option is useful when you wish to copy part of the code of the Library into a program that is not a library.

4. You may copy and distribute the Library (or a portion or derivative of it, under Section 2) in object code or executable form under the terms of Sections 1 and 2 above provided that you accompany it with the complete corresponding machine-readable source code, which must be distributed under the terms of Sections 1 and 2 above on a medium customarily used for software interchange.

If distribution of object code is made by offering access to copy from a designated place, then offering equivalent access to copy the source code from the same place satisfies the requirement to distribute the source code, even though third parties are not compelled to copy the source along with the object code.

5. A program that contains no derivative of any portion of the Library, but is designed to work with the Library by being compiled or linked with it, is called a "work that uses the Library". Such a work, in isolation, is not a derivative work of the Library, and therefore falls outside the scope of this License.

However, linking a "work that uses the Library" with the Library creates an executable that is a derivative of the Library (because it contains portions of the Library), rather than a "work that uses the library". The executable is therefore covered by this License. Section 6 states terms for distribution of such executables.

When a "work that uses the Library" uses material from a header file that is part of the Library, the object code for the work may be a derivative work of the Library even though the source code is not. Whether this is true is especially significant if the work can be linked without the Library, or if the work is itself a library. The threshold for this to be true is not precisely defined by law.

If such an object file uses only numerical parameters, data structure layouts and accessors, and small macros and small inline functions (ten lines or less in length), then the use of the object file is unrestricted, regardless of whether it is legally a derivative work. (Executables containing this object code plus portions of the Library will still fall under Section 6.)

Otherwise, if the work is a derivative of the Library, you may distribute the object code for the work under the terms of Section 6. Any executables containing that work also fall under Section 6, whether or not they are linked directly with the Library itself.

6. As an exception to the Sections above, you may also combine or link a "work that uses the Library" with the Library to produce a work containing portions of the Library, and distribute that work under terms of your choice, provided that the terms permit modification of the work for the customer's own use and reverse engineering for debugging such modifications.

You must give prominent notice with each copy of the work that the Library is used in it and that the Library and its use are covered by this License. You must supply a copy of this License. If the work during execution displays copyright notices, you must include the copyright notice for the Library among them, as well as a reference directing the user to the copy of this License. Also, you must do one of these things:

- Accompany the work with the complete corresponding machine-readable source code for the Library including whatever changes were used in the work (which must be distributed under Sections 1 and 2 above); and, if the work is an executable linked with the Library, with the complete machine-readable "work that uses the Library", as object code and/or source code, so that the user can modify the Library and then relink to produce a modified executable containing the modified Library. (It is understood that the user who changes the contents of definitions files in the Library will not necessarily be able to recompile the application to use the modified definitions.)
- Use a suitable shared library mechanism for linking with the Library. A suitable mechanism is one that (1) uses at run time a copy of the library already present on the user's computer system, rather than copying library functions into the executable, and (2) will operate properly with a modified version of the library, if the user installs one,

as long as the modified version is interface-compatible with the version that the work was made with.

c) Accompany the work with a written offer, valid for at least three years, to give the same user the materials specified in Subsection 6a, above, for a charge no more than the cost of performing this distribution.

d) If distribution of the work is made by offering access to copy from a designated place, offer equivalent access to copy the above specified materials from the same place.

e) Verify that the user has already received a copy of these materials or that you have already sent this user a copy.

For an executable, the required form of the "work that uses the Library" must include any data and utility programs needed for reproducing the executable from it. However, as a special exception, the materials to be distributed need not include anything that is normally distributed (in either source or binary form) with the major components (compiler, kernel, and so on) of the operating system on which the executable runs, unless that component itself accompanies the executable.

It may happen that this requirement contradicts the license restrictions of other proprietary libraries that do not normally accompany the operating system. Such a contradiction means you cannot use both them and the Library together in an executable that you distribute.

7. You may place library facilities that are a work based on the Library side-by-side in a single library together with other library facilities not covered by this License, and distribute such a combined library, provided that the separate distribution of the work based on the Library and of the other library facilities is otherwise permitted, and provided that you do these two things:

a) Accompany the combined library with a copy of the same work based on the Library, uncombined with any other library facilities. This must be distributed under the terms of the Sections above.

b) Give prominent notice with the combined library of the fact that part of it is a work based on the Library, and explaining where to find the accompanying uncombined form of the same work.

8. You may not copy, modify, sublicense, link with, or distribute the Library except as expressly provided under this License. Any attempt otherwise to copy, modify, sublicense, link with, or distribute the Library is void, and will automatically terminate your rights under this License. However, parties who have received copies, or rights, from you under this License will not have their licenses terminated so long as such parties remain in full compliance.

9. You are not required to accept this License, since you have not signed it. However, nothing else grants you permission to modify or distribute the Library or its derivative works. These actions are prohibited by law if you do not accept this License. Therefore, by modifying or distributing the Library (or any work based on the Library), you indicate your acceptance of this License to do so, and all its terms and conditions for copying, distributing or modifying the Library or works based on it.

10. Each time you redistribute the Library (or any work based on the Library), the recipient automatically receives a license from the original licensor to copy, distribute, link with or modify the Library subject to these terms and conditions. You may not impose any further restrictions on the recipients' exercise of the rights granted herein. You are not responsible for enforcing compliance by third parties with this License.

11. If, as a consequence of a court judgment or allegation of patent infringement or for any other reason (not limited to patent issues), conditions are imposed on you (whether by court order, agreement or otherwise) that contradict the conditions of this License, they do not excuse you from the conditions of this License. If you cannot distribute so as to satisfy simultaneously your obligations under this License and any other pertinent obligations, then as a consequence you may not distribute the Library at all. For example, if a patent license would not permit royalty-free redistribution of the Library by all those who receive copies directly or indirectly through you, then the only way you could satisfy both it and this License would be to refrain entirely from distribution of the Library.

If any portion of this section is held invalid or unenforceable under any particular circumstance, the balance of the section is intended to apply, and the section as a whole is intended to apply in other circumstances.

It is not the purpose of this section to induce you to infringe any patents or other property right claims or to contest validity of any such claims; this section has the sole purpose of protecting the integrity of the free software distribution system which is implemented by public license practices. Many people have made generous contributions to the wide range of software distributed through that system in reliance on

consistent application of that system; it is up to the author/donor to decide if he or she is willing to distribute software through any other system and a licensee cannot impose that choice.

This section is intended to make thoroughly clear what is believed to be a consequence of the rest of this License.

12. If the distribution and/or use of the Library is restricted in certain countries either by patents or by copyrighted interfaces, the original copyright holder who places the Library under this License may add an explicit geographical distribution limitation excluding those countries, so that distribution is permitted only in or among countries not thus excluded. In such case, this License incorporates the limitation as if written in the body of this License.

13. The Free Software Foundation may publish revised and/or new versions of the Lesser General Public License from time to time. Such new versions will be similar in spirit to the present version, but may differ in detail to address new problems or concerns.

Each version is given a distinguishing version number. If the Library specifies a version number of this License which applies to it and "any later version", you have the option of following the terms and conditions either of that version or of any later version published by the Free Software Foundation. If the Library does not specify a license version number, you may choose any version ever published by the Free Software Foundation.

14. If you wish to incorporate parts of the Library into other free programs whose distribution conditions are incompatible with these, write to the author to ask for permission. For software which is copyrighted by the Free Software Foundation, write to the Free Software Foundation; we sometimes make exceptions for this. Our decision will be guided by the two goals of preserving the free status of all derivatives of our free software and of promoting the sharing and reuse of software generally.

NO WARRANTY

15. BECAUSE THE LIBRARY IS LICENSED FREE OF CHARGE, THERE IS NO WARRANTY FOR THE LIBRARY, TO THE EXTENT PERMITTED BY APPLICABLE LAW. EXCEPT WHEN OTHERWISE STATED IN WRITING THE COPYRIGHT HOLDERS AND/OR OTHER PARTIES PROVIDE THE LIBRARY "AS IS" WITHOUT WARRANTY OF ANY KIND, EITHER EXPRESSED OR IMPLIED, INCLUDING, BUT NOT LIMITED TO, THE IMPLIED WARRANTIES OF MERCHANTABILITY AND FITNESS FOR A PARTICULAR PURPOSE. THE ENTIRE RISK AS TO THE QUALITY AND PERFORMANCE OF THE LIBRARY IS WITH YOU. SHOULD THE LIBRARY PROVE DEFECTIVE, YOU ASSUME THE COST OF ALL NECESSARY SERVICING, REPAIR OR CORRECTION.

16. IN NO EVENT UNLESS REQUIRED BY APPLICABLE LAW OR AGREED TO IN WRITING WILL ANY COPYRIGHT HOLDER, OR ANY OTHER PARTY WHO MAY MODIFY AND/OR REDISTRIBUTE THE LIBRARY AS PERMITTED ABOVE, BE LIABLE TO YOU FOR DAMAGES, INCLUDING ANY GENERAL, SPECIAL, INCIDENTAL OR CONSEQUENTIAL DAMAGES ARISING OUT OF THE USE OR INABILITY TO USE THE LIBRARY (INCLUDING BUT NOT LIMITED TO LOSS OF DATA OR DATA BEING RENDERED INACCURATE OR LOSSES SUSTAINED BY YOU OR THIRD PARTIES OR A FAILURE OF THE LIBRARY TO OPERATE WITH ANY OTHER SOFTWARE), EVEN IF SUCH HOLDER OR OTHER PARTY HAS BEEN ADVISED OF THE POSSIBILITY OF SUCH DAMAGES.

END OF TERMS AND CONDITIONS

How to Apply These Terms to Your New Libraries

If you develop a new library, and you want it to be of the greatest possible use to the public, we recommend making it free software that everyone can redistribute and change. You can do so by permitting redistribution under these terms (or, alternatively, under the terms of the ordinary General Public License).

To apply these terms, attach the following notices to the library. It is safest to attach them to the start of each source file to most effectively convey the exclusion of warranty; and each file should have at least the "copyright" line and a pointer to where the full notice is found.

one line to give the library's name and an idea of what it does.

Copyright (C) year name of author

This library is free software; you can redistribute it and/or

modify it under the terms of the GNU Lesser General Public

License as published by the Free Software Foundation; either

version 2.1 of the License, or (at your option) any later version.

This library is distributed in the hope that it will be useful,

but WITHOUT ANY WARRANTY; without even the implied warranty of MERCHANTABILITY or FITNESS FOR A PARTICULAR PURPOSE. See the GNU

Lesser General Public License for more details.

You should have received a copy of the GNU Lesser General Public License along with this library; if not, write to the Free Software Foundation, Inc., 59 Temple Place, Suite 330, Boston, MA 02111-1307 USA

Also add information on how to contact you by electronic and paper mail.

You should also get your employer (if you work as a programmer) or your school, if any, to sign a "copyright disclaimer" for the library, if necessary. Here is a sample; alter the names:

Yoyodyne, Inc., hereby disclaims all copyright interest in

the library 'Frob' (a library for tweaking knobs) written

by James Random Hacker.

signature of Ty Coon, 1 April 1990

Ty Coon, President of Vice

That's all there is to it!

MOZILLA PUBLIC LICENSE

Copyright (c) 2004, Apple Computer, Inc. and The Mozilla Foundation.

Copyright (c) 2004-2005 HighPoint Technologies, Inc.

Copyright (c) 2004-2005 HighPoint Technologies, Inc.

Version 1.1

1. Definitions.

1.0.1. "Commercial Use" means distribution or otherwise making the Covered Code available to a third party.

1.1. "Contributor" means each entity that creates or contributes to the creation of Modifications.

1.2. "Contributor Version" means the combination of the Original Code, prior Modifications used by a Contributor, and the Modifications made by that particular Contributor.

1.3. "Covered Code" means the Original Code or Modifications or the combination of the Original Code and Modifications, in each case including portions thereof.

1.4. "Electronic Distribution Mechanism" means a mechanism generally accepted in the software development community for the electronic transfer of data.

1.5. "Executable" means Covered Code in any form other than Source Code.

1.6. "Initial Developer" means the individual or entity identified as the Initial Developer in the Source Code notice required by **Exhibit A**.

1.7. "Larger Work" means a work which combines Covered Code or portions thereof with code not governed by the terms of this License.

1.8. "License" means this document.

1.8.1. "Licensable" means having the right to grant, to the maximum extent possible, whether at the time of the initial grant or subsequently acquired, any and all of the rights conveyed herein.

1.9. "Modifications" means any addition to or deletion from the substance or structure of either the Original Code or any previous Modifications. When Covered Code is released as a series of files, a Modification is:

A. Any addition to or deletion from the contents of a file containing Original Code or previous Modifications.

B. Any new file that contains any part of the Original Code or previous Modifications.

1.10. "Original Code" means Source Code of computer software code which is described in the Source Code notice required by **Exhibit A** as Original Code, and which, at the time of its release under this License is not already Covered Code governed by this License.

1.10.1. "Patent Claims" means any patent claim(s), now owned or hereafter acquired, including without limitation, method, process, and apparatus claims, in any patent Licensable by grantor.

1.11. "Source Code" means the preferred form of the Covered Code for making modifications to it, including all modules it contains, plus any associated interface definition files, scripts used to control compilation and installation of an Executable, or source code differential comparisons against either the Original Code or another well known, available Covered Code of the Contributor's choice. The Source Code can be in a compressed or archival form, provided the appropriate decompression or de-archiving software is widely available for no charge.

1.12. "You" (or "Your") means an individual or a legal entity exercising rights under, and complying with all of the terms of, this License or a future version of this License issued under Section 6.1. For legal entities, "You" includes any entity which controls, is controlled by, or is under common control with You. For purposes of this definition, "control" means (a) the power, direct or indirect, to cause the direction or management of such entity, whether by contract or otherwise, or (b) ownership of more than fifty percent (50%) of the outstanding shares or beneficial ownership of such entity.

2. Source Code License.

2.1. The Initial Developer Grant. The Initial Developer hereby grants You a world-wide, royalty-free, non-exclusive license, subject to third party intellectual property claims:

(a) under intellectual property rights (other than patent or trademark) Licensable by Initial Developer to use, reproduce, modify, display, perform, sublicense and distribute the Original Code (or portions thereof) with or without Modifications, and/or as part of a Larger Work; and

(b) under Patents Claims infringed by the making, using or selling of Original Code, to make, have made, use, practice, sell, and offer for sale, and/or otherwise dispose of the Original Code (or portions thereof).

(c) the licenses granted in this Section 2.1(a) and (b) are effective on the date Initial Developer first distributes Original Code under the terms of this License.

(d) Notwithstanding Section 2.1(b) above, no patent license is granted: 1) for code that You delete from the Original Code; 2) separate from the Original Code; or 3) for infringements caused by: i) the modification of the Original Code or ii) the combination of the Original Code with other software or devices.

2.2. Contributor Grant. Subject to third party intellectual property claims, each Contributor hereby grants You a world-wide, royalty-free, non-exclusive license

(a) under intellectual property rights (other than patent or trademark) Licensable by Contributor, to use, reproduce, modify, display, perform, sublicense and distribute the Modifications created by such Contributor (or portions thereof) either on an unmodified basis, with other Modifications, as Covered Code and/or as part of a Larger Work; and

(b) under Patent Claims infringed by the making, using, or selling of Modifications made by that Contributor either alone and/or in combination with its Contributor Version (or portions of such combination), to make, use, sell, offer for sale, have made, and/or otherwise dispose of: 1) Modifications made by that Contributor (or portions thereof); and 2) the combination of Modifications made by that Contributor with its Contributor Version (or portions of such combination).

(c) the licenses granted in Sections 2.2(a) and 2.2(b) are effective on the date Contributor first makes Commercial Use of the Covered Code.

(d) Notwithstanding Section 2.2(b) above, no patent license is granted: 1) for any code that Contributor has deleted from the Contributor Version; 2) separate from the Contributor Version; 3) for infringements caused by: i) third party modifications of Contributor Version or ii) the combination of Modifications made by that Contributor with other software (except as part of the Contributor Version) or other devices; or 4) under Patent Claims infringed by Covered Code in the absence of Modifications made by that Contributor.

3. Distribution Obligations.

3.1. Application of License. The Modifications which You create or to which You contribute are governed by the terms of this License, including without limitation Section **2.2**. The Source Code version of Covered Code may be distributed only under the terms of this License or a future version of this License released under Section **6.1**, and You must include a copy of this License with every copy of the Source

Code You distribute. You may not offer or impose any terms on any Source Code version that alters or restricts the applicable version of this License or the recipients' rights hereunder. However, You may include an additional document offering the additional rights described in Section 3.5.

3.2. Availability of Source Code. Any Modification which You create or to which You contribute must be made available in Source Code form under the terms of this License either on the same media as an Executable version or via an accepted Electronic Distribution Mechanism to anyone to whom you made an Executable version available; and if made available via Electronic Distribution Mechanism, must remain available for at least twelve (12) months after the date it initially became available, or at least six (6) months after a subsequent version of that particular Modification has been made available to such recipients. You are responsible for ensuring that the Source Code version remains available even if the Electronic Distribution Mechanism is maintained by a third party.

3.3. Description of Modifications. You must cause all Covered Code to which You contribute to contain a file documenting the changes You made to create that Covered Code and the date of any change. You must include a prominent statement that the Modification is derived, directly or indirectly, from Original Code provided by the Initial Developer and including the name of the Initial Developer in (a) the Source Code, and (b) in any notice in an Executable version or related documentation in which You describe the origin or ownership of the Covered Code.

3.4. Intellectual Property Matters

(a) Third Party Claims. If Contributor has knowledge that a license under a third party's intellectual property rights is required to exercise the rights granted by such Contributor under Sections 2.1 or 2.2, Contributor must include a text file with the Source Code distribution titled "LEGAL" which describes the claim and the party making the claim in sufficient detail that a recipient will know whom to contact. If Contributor obtains such knowledge after the Modification is made available as described in Section 3.2, Contributor shall promptly modify the LEGAL file in all copies Contributor makes available thereafter and shall take other steps (such as notifying appropriate mailing lists or newsgroups) reasonably calculated to inform those who received the Covered Code that new knowledge has been obtained.

(b) Contributor APIs. If Contributor's Modifications include an application programming interface and Contributor has knowledge of patent licenses which are reasonably necessary to implement that API, Contributor must also include this information in the LEGAL file.

(c) Representations.

Contributor represents that, except as disclosed pursuant to Section 3.4(a) above, Contributor believes that Contributor's Modifications are Contributor's original creation(s) and/or Contributor has sufficient rights to grant the rights conveyed by this License.

3.5. Required Notices. You must duplicate the notice in **Exhibit A** in each file of the Source Code. If it is not possible to put such notice in a particular Source Code file due to its structure, then You must include such notice in a location (such as a relevant directory) where a user would be likely to look for such a notice. If You created one or more Modification(s) You may add your name as a Contributor to the notice described in **Exhibit A**. You must also duplicate this License in any documentation for the Source Code where You describe recipients' rights or ownership rights relating to Covered Code. You may choose to offer, and to charge a fee for, warranty, support, indemnity or liability obligations to one or more recipients of Covered Code. However, You may do so only on Your own behalf, and not on behalf of the Initial Developer or any Contributor. You must make it absolutely clear that any such warranty, support, indemnity or liability obligation is offered by You alone, and You hereby agree to indemnify the Initial Developer and every Contributor for any liability incurred by the Initial Developer or such Contributor as a result of warranty, support, indemnity or liability terms You offer.

3.6. Distribution of Executable Versions. You may distribute Covered Code in Executable form only if the requirements of Section 3.1-3.5 have been met for that Covered Code, and if You include a notice stating that the Source Code version of the Covered Code is available under the terms of this License, including a description of how and where You have fulfilled the obligations of Section 3.2. The notice must be conspicuously included in any notice in an Executable version, related documentation or collateral in which You describe recipients'

rights relating to the Covered Code. You may distribute the Executable version of Covered Code or ownership rights under a license of Your choice, which may contain terms different from this License, provided that You are in compliance with the terms of this License and that the license for the Executable version does not attempt to limit or alter the recipient's rights in the Source Code version from the rights set forth in this License. If You distribute the Executable version under a different license You must make it absolutely clear that any terms which differ from this License are offered by You alone, not by the Initial Developer or any Contributor. You hereby agree to indemnify the Initial Developer and every Contributor for any liability incurred by the Initial Developer or such Contributor as a result of any such terms You offer.

3.7. Larger Works. You may create a Larger Work by combining Covered Code with other code not governed by the terms of this License and distribute the Larger Work as a single product. In such a case, You must make sure the requirements of this License are fulfilled for the Covered Code.

4. Inability to Comply Due to Statute or Regulation.

If it is impossible for You to comply with any of the terms of this License with respect to some or all of the Covered Code due to statute, judicial order, or regulation then You must: (a) comply with the terms of this License to the maximum extent possible; and (b) describe the limitations and the code they affect. Such description must be included in the LEGAL file described in Section 3.4 and must be included with all distributions of the Source Code. Except to the extent prohibited by statute or regulation, such description must be sufficiently detailed for a recipient of ordinary skill to be able to understand it.

5. Application of this License.

This License applies to code to which the Initial Developer has attached the notice in **Exhibit A** and to related Covered Code.

6. Versions of the License.

6.1. New Versions. Netscape Communications Corporation ("Netscape") may publish revised and/or new versions of the License from time to time. Each version will be given a distinguishing version number.

6.2. Effect of New Versions. Once Covered Code has been published under a particular version of the License, You may always continue to use it under the terms of that version. You may also choose to use such Covered Code under the terms of any subsequent version of the License published by Netscape. No one other than Netscape has the right to modify the terms applicable to Covered Code created under this License.

6.3. Derivative Works. If You create or use a modified version of this License (which you may only do in order to apply it to code which is not already Covered Code governed by this License), You must (a) rename Your license so that the phrases "Mozilla", "MOZILLAPL", "MOZPL", "Netscape", "MPL", "NPL" or any confusingly similar phrase do not appear in your license (except to note that your license differs from this License) and (b) otherwise make it clear that Your version of the license contains terms which differ from the Mozilla Public License and Netscape Public License. (Filling in the name of the Initial Developer, Original Code or Contributor in the notice described in **Exhibit A** shall not of themselves be deemed to be modifications of this License.)

7. DISCLAIMER OF WARRANTY. COVERED CODE IS PROVIDED UNDER THIS LICENSE ON AN "AS IS" BASIS, WITHOUT WARRANTY OF ANY KIND, EITHER EXPRESSED OR IMPLIED, INCLUDING, WITHOUT LIMITATION, WARRANTIES THAT THE COVERED CODE IS FREE OF DEFECTS, MERCHANTABLE, FIT FOR A PARTICULAR PURPOSE OR NON-INFRINGEMENT. THE ENTIRE RISK AS TO THE QUALITY AND PERFORMANCE OF THE COVERED CODE IS WITH YOU. SHOULD ANY COVERED CODE PROVE DEFECTIVE IN ANY RESPECT, YOU (NOT THE INITIAL DEVELOPER OR ANY OTHER CONTRIBUTOR) ASSUME THE COST OF ANY NECESSARY SERVICING, REPAIR OR CORRECTION. THIS DISCLAIMER OF WARRANTY CONSTITUTES AN ESSENTIAL PART OF THIS LICENSE. NO USE OF ANY COVERED CODE IS AUTHORIZED HEREUNDER EXCEPT UNDER THIS DISCLAIMER.

8. TERMINATION.

8.1. This License and the rights granted hereunder will terminate automatically if You fail to comply with terms herein and fail to cure such breach within 30 days of becoming aware of the breach. All sublicenses to the Covered Code which are properly granted shall survive any termination of this License. Provisions which, by their nature, must remain in effect beyond the termination of this License shall survive.

8.2. If You initiate litigation by asserting a patent infringement claim (excluding declaratory judgment actions) against Initial Developer or a Contributor (the Initial Developer or Contributor against whom You file such action is referred to as "Participant") alleging that:

(a) such Participant's Contributor Version directly or indirectly infringes any patent, then any and all rights granted by such Participant to You under Sections 2.1 and/or 2.2 of this License shall, upon 60 days notice from Participant terminate prospectively, unless if within 60 days after receipt of notice You either: (i) agree in writing to pay Participant a mutually agreeable reasonable royalty for Your past and future use of Modifications made by such Participant, or (ii) withdraw Your litigation claim with respect to the Contributor Version against such Participant. If within 60 days of notice, a reasonable royalty and payment arrangement are not mutually agreed upon in writing by the parties or the litigation claim is not withdrawn, the rights granted by Participant to You under Sections 2.1 and/or 2.2 automatically terminate at the expiration of the 60 day notice period specified above.

(b) any software, hardware, or device, other than such Participant's Contributor Version, directly or indirectly infringes any patent, then any rights granted to You by such Participant under Sections 2.1(b) and 2.2(b) are revoked effective as of the date You first made, used, sold, distributed, or had made, Modifications made by that Participant.

8.3. If You assert a patent infringement claim against Participant alleging that such Participant's Contributor Version directly or indirectly infringes any patent where such claim is resolved (such as by license or settlement) prior to the initiation of patent infringement litigation, then the reasonable value of the licenses granted by such Participant under Sections 2.1 or 2.2 shall be taken into account in determining the amount or value of any payment or license.

8.4. In the event of termination under Sections 8.1 or 8.2 above, all end user license agreements (excluding distributors and resellers) which have been validly granted by You or any distributor hereunder prior to termination shall survive termination.

9. LIMITATION OF LIABILITY. UNDER NO CIRCUMSTANCES AND UNDER NO LEGAL THEORY, WHETHER TORT (INCLUDING NEGLIGENCE), CONTRACT, OR OTHERWISE, SHALL YOU, THE INITIAL DEVELOPER, ANY OTHER CONTRIBUTOR, OR ANY DISTRIBUTOR OF COVERED CODE, OR ANY SUPPLIER OF ANY OF SUCH PARTIES, BE LIABLE TO ANY PERSON FOR ANY INDIRECT, SPECIAL, INCIDENTAL, OR CONSEQUENTIAL DAMAGES OF ANY CHARACTER INCLUDING, WITHOUT LIMITATION, DAMAGES FOR LOSS OF GOODWILL, WORK STOPPAGE, COMPUTER FAILURE OR MALFUNCTION, OR ANY AND ALL OTHER COMMERCIAL DAMAGES OR LOSSES, EVEN IF SUCH PARTY SHALL HAVE BEEN INFORMED OF THE POSSIBILITY OF SUCH DAMAGES. THIS LIMITATION OF LIABILITY SHALL NOT APPLY TO LIABILITY FOR DEATH OR PERSONAL INJURY RESULTING FROM SUCH PARTY'S NEGLIGENCE TO THE EXTENT APPLICABLE LAW PROHIBITS SUCH LIMITATION. SOME JURISDICTIONS DO NOT ALLOW THE EXCLUSION OR LIMITATION OF INCIDENTAL OR CONSEQUENTIAL DAMAGES, SO THIS EXCLUSION AND LIMITATION MAY NOT APPLY TO YOU.

10. U.S. GOVERNMENT END USERS.

The Covered Code is a "commercial item," as that term is defined in 48 C.F.R. 2.101 (Oct. 1995), consisting of "commercial computer software" and "commercial computer software documentation," as such terms are used in 48 C.F.R. 12.212 (Sept. 1995). Consistent with 48 C.F.R. 12.212 and 48 C.F.R. 227.7202-1 through 227.7202-4 (June 1995), all U.S. Government End Users acquire Covered Code with only those rights set forth herein.

11. MISCELLANEOUS.

This License represents the complete agreement concerning subject matter hereof. If any provision of this License is held to be unenforceable, such provision shall be reformed only to the extent necessary to make it enforceable. This License shall be governed by California law provisions (except to the extent applicable law, if any, provides otherwise), excluding its conflict-of-law provisions. With respect to disputes in which at least one party is a citizen of, or an entity chartered or registered to do business in the United States of America, any litigation relating to this License shall be subject to the jurisdiction of the Federal Courts of the Northern District of California, with venue lying in Santa Clara County, California, with the losing party responsible for costs, including without limitation, court costs and reasonable attorneys' fees and expenses. The application of the United Nations Convention on Contracts for the International Sale of Goods is expressly excluded. Any law or regulation which provides that the language of a contract shall be construed against the drafter shall not apply to this License.

12. RESPONSIBILITY FOR CLAIMS.

As between Initial Developer and the Contributors, each party is responsible for claims and damages arising, directly or indirectly, out of its utilization of rights under this License and You agree to work with Initial Developer and Contributors to distribute such responsibility on an equitable basis. Nothing herein is intended or shall be deemed to constitute any admission of liability.

13. MULTIPLE-LICENSED CODE.

Initial Developer may designate portions of the Covered Code as Multiple-Licensed. Multiple-Licensed means that the Initial Developer permits you to utilize portions of the Covered Code under Your choice of the MPL or the alternative licenses, if any, specified by the Initial Developer in the file described in Exhibit A.

EXHIBIT A -Mozilla Public License.

The contents of this file are subject to the Mozilla Public License Version 1.1 (the "License"); you may not use this file except in compliance with the License. You may obtain a copy of the License at <http://www.mozilla.org/MPL/>

Software distributed under the License is distributed on an "AS IS" basis, WITHOUT WARRANTY OF ANY KIND, either express or implied. See the License for the specific language governing rights and limitations under the License.

The Original Code is _____.

The Initial Developer of the Original Code is _____.
Portions created by _____ are Copyright (C) _____.
All Rights Reserved.

Contributor(s): _____.

Alternatively, the contents of this file may be used under the terms of the _____ license (the _____ License), in which case the provisions of _____ License are applicable instead of those above. If you wish to allow use of your version of this file only under the terms of the _____ License and not to allow others to use your version of this file under the MPL, indicate your decision by deleting the provisions above and replace them with the notice and other provisions required by the _____ License. If you do not delete the provisions above, a recipient may use your version of this file under either the MPL or the _____ License."

[NOTE: The text of this Exhibit A may differ slightly from the text of the notices in the Source Code files of the Original Code. You should use the text of this Exhibit A rather than the text found in the Original Code Source Code for Your Modifications.]

BSD Two Clause License

Copyright (c) 2004-2005 HighPoint Technologies, Inc.

All rights reserved.

Redistribution and use in source and binary forms, with or without modification, are permitted provided that the following conditions are met:

1. Redistributions of source code must retain the above copyright notice, this list of conditions and the following disclaimer.
2. Redistributions in binary form must reproduce the above copyright notice, this list of conditions and the following disclaimer in the documentation and/or other materials provided with the distribution.

THIS SOFTWARE IS PROVIDED BY THE AUTHOR "AS IS" AND ANY EXPRESS OR IMPLIED WARRANTIES, INCLUDING, BUT NOT LIMITED TO, THE IMPLIED WARRANTIES OF MERCHANTABILITY AND FITNESS FOR A PARTICULAR PURPOSE ARE DISCLAIMED. IN NO EVENT SHALL THE AUTHOR BE LIABLE FOR ANY DIRECT, INDIRECT, INCIDENTAL, SPECIAL, EXEMPLARY, OR CONSEQUENTIAL DAMAGES (INCLUDING, BUT NOT LIMITED TO, PROCUREMENT OF SUBSTITUTE GOODS OR SERVICES; LOSS OF USE, DATA, OR PROFITS; OR BUSINESS INTERRUPTION) HOWEVER CAUSED AND ON ANY THEORY OF LIABILITY, WHETHER IN CONTRACT, STRICT LIABILITY, OR TORT (INCLUDING NEGLIGENCE OR OTHERWISE) ARISING IN ANY WAY OUT OF THE USE OF THIS SOFTWARE, EVEN IF ADVISED OF THE POSSIBILITY OF SUCH DAMAGE.

BSD 3-clause License

Copyright (c) 2000-2013, Marvell International Ltd.

Copyright (c) 2008-2009, Alex Weber.

Copyright (c) 2005, Tom Wu.

Copyright (c) 2000-2009, Paul Johnston.

Copyright (c) 1994-1997, Thomas G. Lane.

Copyright (c) 2009, 2011, D. R. Commander.

Copyright (c) 2009 Texas Instruments Incorporated - <http://www.ti.com/>

Copyright (c) 2006 Alexander Chemeris.

Copyright (c) 2003 Sun Microsystems, Inc.

Copyright (c) 2010-2015, The Dojo Foundation.

Copyright (c) 2005-2007 Paul Hsieh.

Copyright (c) Alexandru Marasteanu.

Copyright (c) 2003, 2010, Dr Brian Gladman, Worcester, UK.

Copyright (c) 2002-2008, Milan Ikits <milan.ikits@jeee.org>

Copyright (c) 2002-2008, Marcelo E. Magallon <mmagallo@debian.org>

Copyright (c) 2002, Lev Povalaha.

Copyright (c) 2007 The Khronos Group Inc.

All rights reserved.

Redistribution and use in source and binary forms, with or without modification, are permitted provided that the following conditions are met:

- Redistributions of source code must retain the above copyright notice, this list of conditions and the following disclaimer.
- Redistributions in binary form must reproduce the above copyright notice, this list of conditions and the following disclaimer in the documentation and/or other materials provided with the distribution.
- Neither the name of the <ORGANIZATION> nor the names of its contributors may be used to endorse or promote products derived from this software without specific prior written permission.

THIS SOFTWARE IS PROVIDED BY THE COPYRIGHT HOLDERS AND CONTRIBUTORS "AS IS" AND ANY EXPRESS OR IMPLIED WARRANTIES, INCLUDING, BUT NOT LIMITED TO, THE IMPLIED WARRANTIES OF MERCHANTABILITY AND FITNESS FOR A PARTICULAR PURPOSE ARE DISCLAIMED. IN NO EVENT SHALL THE COPYRIGHT OWNER OR CONTRIBUTORS BE LIABLE FOR ANY DIRECT, INDIRECT, INCIDENTAL, SPECIAL, EXEMPLARY, OR CONSEQUENTIAL DAMAGES (INCLUDING, BUT NOT LIMITED TO, PROCUREMENT OF SUBSTITUTE GOODS OR SERVICES; LOSS OF USE, DATA, OR PROFITS; OR BUSINESS INTERRUPTION) HOWEVER CAUSED AND ON ANY THEORY OF LIABILITY, WHETHER IN CONTRACT, STRICT LIABILITY, OR TORT (INCLUDING NEGLIGENCE OR OTHERWISE) ARISING IN ANY WAY OUT OF THE USE OF THIS SOFTWARE, EVEN IF ADVISED OF THE POSSIBILITY OF SUCH DAMAGE.

The MIT License

Copyright (c) 2008-2010 Adrian Tosca

Copyright (c) 2010-2011 Itrium LLC

Copyright (c) 2009 Dave Gamble

Copyright (c) 2008-2011 Martin Wendt

Copyright (c) 2003-2005 Tom Wu

Copyright (c) 2008 Tony Tomov

Copyright (c) 2012, AUTHORS.txt (<http://jqueryui.com/about>)

Copyright (c) 2010 “Cowboy” Ben Alman

Copyright (c) 2009-2011 Brantley Harris

Copyright (c) 2011-2012 Timo Tijhof

Copyright (c) 2006-2011 Sam Collett (<http://www.textotela.co.uk>)

Copyright (c) 2009 Wroclaw

Copyright (c) 2008-2012 Dmitry Baranovskiy

Copyright (c) 2008-2012 Sencha Labs

Copyright (c) 2007,2014 JQuery Foundation and other contributors

Permission is hereby granted, free of charge, to any person obtaining a copy of this software and associated documentation files (the "Software"), to deal in the Software without restriction, including without limitation the rights to use, copy, modify, merge, publish, distribute, sublicense, and/or sell copies of the Software, and to permit persons to whom the Software is furnished to do so, subject to the following conditions:

The above copyright notice and this permission notice shall be included in all copies or substantial portions of the Software.

THE SOFTWARE IS PROVIDED "AS IS", WITHOUT WARRANTY OF ANY KIND, EXPRESS OR IMPLIED, INCLUDING BUT NOT LIMITED TO THE WARRANTIES OF MERCHANTABILITY, FITNESS FOR A PARTICULAR PURPOSE AND NONINFRINGEMENT. IN NO EVENT SHALL THE AUTHORS OR COPYRIGHT HOLDERS BE LIABLE FOR ANY CLAIM, DAMAGES OR OTHER LIABILITY, WHETHER IN AN ACTION OF CONTRACT, TORT OR OTHERWISE, ARISING FROM, OUT OF OR IN CONNECTION WITH THE SOFTWARE OR THE USE OR OTHER DEALINGS IN THE SOFTWARE.

libxml2 License

Except where otherwise noted in the source code (e.g. the files hash.c, list.c and the trio files, which are covered by a similar licence but with different Copyright notices) all the files are:

Copyright (C) 1998-2003 Daniel Veillard. All Rights Reserved.

Permission is hereby granted, free of charge, to any person obtaining a copy of this software and associated documentation files (the "Software"), to deal in the Software without restriction, including without limitation the rights to use, copy, modify, merge, publish, distribute, sublicense, and/or sell copies of the Software, and to permit persons to whom the Software is furnished to do so, subject to the following conditions:

The above copyright notice and this permission notice shall be included in all copies or substantial portions of the Software.

THE SOFTWARE IS PROVIDED "AS IS", WITHOUT WARRANTY OF ANY KIND, EXPRESS OR IMPLIED, INCLUDING BUT NOT LIMITED TO THE WARRANTIES OF MERCHANTABILITY, FITNESS FOR A PARTICULAR PURPOSE AND NONINFRINGEMENT. IN NO EVENT SHALL THE DANIEL VEILLARD BE LIABLE FOR ANY CLAIM, DAMAGES OR OTHER LIABILITY, WHETHER IN AN ACTION OF CONTRACT, TORT OR OTHERWISE, ARISING FROM, OUT OF OR IN CONNECTION WITH THE SOFTWARE OR THE USE OR OTHER DEALINGS IN THE SOFTWARE.

Except as contained in this notice, the name of Daniel Veillard shall not be used in advertising or otherwise to promote the sale, use or other dealings in this Software without prior written authorization from him.

Apache License Version 2.0, January 2004

Copyright (c) 2015 Saminda Abeyruwan (saminda@cs.miami.edu)

<http://www.apache.org/licenses/>

TERMS AND CONDITIONS FOR USE, REPRODUCTION, AND DISTRIBUTION

1. Definitions.

"License" shall mean the terms and conditions for use, reproduction, and distribution as defined by Sections 1 through 9 of this document.

"Licensor" shall mean the copyright owner or entity authorized by the copyright owner that is granting the License.

"Legal Entity" shall mean the union of the acting entity and all other entities that control, are controlled by, or are under common control with that entity. For the purposes of this definition, "control" means (i) the power, direct or indirect, to cause the direction or management of such entity, whether by contract or otherwise, or (ii) ownership of fifty percent (50%) or more of the outstanding shares, or (iii) beneficial ownership of such entity.

"You" (or "Your") shall mean an individual or Legal Entity exercising permissions granted by this License.

"Source" form shall mean the preferred form for making modifications, including but not limited to software source code, documentation source, and configuration files.

"Object" form shall mean any form resulting from mechanical transformation or translation of a Source form, including but not limited to compiled object code, generated documentation, and conversions to other media types.

"Work" shall mean the work of authorship, whether in Source or Object form, made available under the License, as indicated by a copyright notice that is included in or attached to the work (an example is provided in the Appendix below).

"Derivative Works" shall mean any work, whether in Source or Object form, that is based on (or derived from) the Work and for which the editorial revisions, annotations, elaborations, or other modifications represent, as a whole, an original work of authorship. For the purposes of this License, Derivative Works shall not include works that remain

separable from, or merely link (or bind by name) to the interfaces of, the Work and Derivative Works thereof.

"Contribution" shall mean any work of authorship, including the original version of the Work and any modifications or additions to that Work or Derivative Works thereof, that is intentionally submitted to Licensor for inclusion in the Work by the copyright owner or by an individual or Legal Entity authorized to submit on behalf of the copyright owner. For the purposes of this definition, "submitted" means any form of electronic, verbal, or written communication sent to the Licensor or its representatives, including but not limited to communication on electronic mailing lists, source code control systems, and issue tracking systems that are managed by, or on behalf of, the Licensor for the purpose of discussing and improving the Work, but excluding communication that is conspicuously marked or otherwise designated in writing by the copyright owner as "Not a Contribution."

"Contributor" shall mean Licensor and any individual or Legal Entity on behalf of whom a Contribution has been received by Licensor and subsequently incorporated within the Work.

2. Grant of Copyright License. Subject to the terms and conditions of this License, each Contributor hereby grants to You a perpetual, worldwide, non-exclusive, no-charge, royalty-free, irrevocable copyright license to reproduce, prepare Derivative Works of, publicly display, publicly perform, sublicense, and distribute the Work and such Derivative Works in Source or Object form.

3. Grant of Patent License. Subject to the terms and conditions of this License, each Contributor hereby grants to You a perpetual, worldwide, non-exclusive, no-charge, royalty-free, irrevocable (except as stated in this section) patent license to make, have made, use, offer to sell, sell, import, and otherwise transfer the Work, where such license applies only to those patent claims licensable by such Contributor that are necessarily infringed by their Contribution(s) alone or by combination of their Contribution(s) with the Work to which such Contribution(s) was submitted. If You institute patent litigation against any entity (including a cross-claim or counterclaim in a lawsuit) alleging that the Work or a Contribution incorporated within the Work constitutes direct or contributory patent infringement, then any patent licenses granted to You under this License for that Work shall terminate as of the date such litigation is filed.

4. Redistribution. You may reproduce and distribute copies of the Work or Derivative Works thereof in any medium, with or without modifications, and in Source or Object form, provided that You meet the following conditions:

- a. You must give any other recipients of the Work or Derivative Works a copy of this License; and
- b. You must cause any modified files to carry prominent notices stating that You changed the files; and
- c. You must retain, in the Source form of any Derivative Works that You distribute, all copyright, patent, trademark, and attribution notices from the Source form of the Work, excluding those notices that do not pertain to any part of the Derivative Works; and
- d. If the Work includes a "NOTICE" text file as part of its distribution, then any Derivative Works that You distribute must include a readable copy of the attribution notices contained within such NOTICE file, excluding those notices that do not pertain to any part of the Derivative Works, in at least one of the following places: within a NOTICE text file distributed as part of the Derivative Works; within the Source form or documentation, if provided along with the Derivative Works; or, within a display generated by the Derivative Works, if and wherever such third-party notices normally appear. The contents of the NOTICE file are for informational purposes only and do not modify the License. You may add Your own attribution notices within Derivative Works that You distribute, alongside or as an addendum to the NOTICE text from the Work, provided that such additional attribution notices cannot be construed as modifying the License.

You may add Your own copyright statement to Your modifications and may provide additional or different license terms and conditions for use, reproduction, or distribution of Your modifications, or for any such Derivative Works as a whole, provided Your use, reproduction, and distribution of the Work otherwise complies with the conditions stated in this License.

5. Submission of Contributions. Unless You explicitly state otherwise, any Contribution intentionally submitted for inclusion in the Work by You to the Licensor shall be under the terms and conditions of this License, without any additional terms or conditions. Notwithstanding the above, nothing herein shall supersede or modify the terms of any separate license agreement you may have executed with Licensor regarding such Contributions.

6. Trademarks. This License does not grant permission to use the trade names, trademarks, service marks, or product names of the Licensor, except as required for reasonable and customary use in describing the origin of the Work and reproducing the content of the NOTICE file.

7. Disclaimer of Warranty. Unless required by applicable law or agreed to in writing, Licensor provides the Work (and each Contributor provides its Contributions) on an "AS IS" BASIS, WITHOUT WARRANTIES OR CONDITIONS OF ANY KIND, either express or implied, including, without limitation, any warranties or conditions of TITLE, NON-INFRINGEMENT, MERCHANTABILITY, or FITNESS FOR A PARTICULAR PURPOSE. You are solely responsible for determining the appropriateness of using or redistributing the Work and assume any risks associated with Your exercise of permissions under this License.

8. Limitation of Liability. In no event and under no legal theory, whether in tort (including negligence), contract, or otherwise, unless required by applicable law (such as deliberate and grossly negligent acts) or agreed to in writing, shall any Contributor be liable to You for damages, including any direct, indirect, special, incidental, or consequential damages of any character arising as a result of this License or out of the use or inability to use the Work (including but not limited to damages for loss of goodwill, work stoppage, computer failure or malfunction, or any and all other commercial damages or losses), even if such Contributor has been advised of the possibility of such damages.

9. Accepting Warranty or Additional Liability. While redistributing the Work or Derivative Works thereof, You may choose to offer, and charge a fee for, acceptance of support, warranty, indemnity, or other liability obligations and/or rights consistent with this License. However, in accepting such obligations, You may act only on Your own behalf and on Your sole responsibility, not on behalf of any other Contributor, and only if You agree to indemnify, defend, and hold each Contributor harmless for any liability incurred by, or claims asserted against, such Contributor by reason of your accepting any such warranty or additional liability.

END OF TERMS AND CONDITIONS

APPENDIX: How to apply the Apache License to your work

To apply the Apache License to your work, attach the following boilerplate notice, with the fields enclosed by brackets "[]" replaced with your own identifying information. (Don't include the brackets!) The text should be enclosed in the appropriate comment syntax for the file format. We also recommend that a file or class name and description of purpose be included on the same "printed page" as the copyright notice for easier identification within third-party archives.

Copyright [yyyy] [name of copyright owner] Licensed under the Apache License, Version 2.0 (the "License"); you may not use this file except in compliance with the License. You may obtain a copy of the License at <http://www.apache.org/licenses/LICENSE-2.0> Unless required by applicable law or agreed to in writing, software distributed under the License is distributed on an "AS IS" BASIS, WITHOUT WARRANTIES OR CONDITIONS OF ANY KIND, either express or implied. See the License for the specific language governing permissions and limitations under the License.

The zlib/libpng License

Copyright (c) 2011 Lee Thomason

Copyright (c) 1995-2012 Jean-loup Gailly and Mark Adler

Copyright (c) 1998-2012 Glenn Randers-Pehrson

Copyright (c) 2003-2005 Hector Mauricio Rodriguez Segura

Copyright (c) 1995-2009 Nullsoft and Contributors

Copyright (c) 2002-2008 Davide Pizzolato

This software is provided 'as-is', without any express or implied warranty. In no event will the authors be held liable for any damages arising from the use of this software.;

Permission is granted to anyone to use this software for any purpose, including commercial applications, and to alter it and redistribute it freely, subject to the following restrictions:

1. The origin of this software must not be misrepresented; you must not claim that you wrote the original software. If you use this software in a product, an acknowledgment in the product documentation would be appreciated but is not required.
2. Altered source versions must be plainly marked as such, and must not be misrepresented as being the original software.

3. This notice may not be removed or altered from any source distribution.

Boost Software License - Version 1.0

August 17th, 2003

Permission is hereby granted, free of charge, to any person or organization obtaining a copy of the software and accompanying documentation covered by this license (the "Software") to use, reproduce, display, distribute, execute, and transmit the Software, and to prepare derivative works of the Software, and to permit third-parties to whom the Software is furnished to do so, all subject to the following:

The copyright notices in the Software and this entire statement, including the above license grant, this restriction and the following disclaimer, must be included in all copies of the Software, in whole or in part, and all derivative works of the Software, unless such copies or derivative works are solely in the form of machine-executable object code generated by a source language processor.

THE SOFTWARE IS PROVIDED "AS IS", WITHOUT WARRANTY OF ANY KIND, EXPRESS OR IMPLIED, INCLUDING BUT NOT LIMITED TO THE WARRANTIES OF MERCHANTABILITY, FITNESS FOR A PARTICULAR PURPOSE, TITLE AND NON-INFRINGEMENT. IN NO EVENT SHALL THE COPYRIGHT HOLDERS OR ANYONE DISTRIBUTING THE SOFTWARE BE LIABLE FOR ANY DAMAGES OR OTHER LIABILITY, WHETHER IN CONTRACT, TORT OR OTHERWISE, ARISING FROM, OUT OF OR IN CONNECTION WITH THE SOFTWARE OR THE USE OR OTHER DEALINGS IN THE SOFTWARE.

Curl License

Copyright (c) 1996 - 2003, Daniel Stenberg, <daniel@haxx.se>.

All rights reserved.

Permission to use, copy, modify, and distribute this software for any purposewith or without fee is hereby granted, provided that the above copyright notice and this permission notice appear in all copies.

THE SOFTWARE IS PROVIDED "AS IS", WITHOUT WARRANTY OF ANY KIND, EXPRESS OR IMPLIED, INCLUDING BUT NOT LIMITED TO THE WARRANTIES OF MERCHANTABILITY, FITNESS FOR A PARTICULAR PURPOSE AND NON-INFRINGEMENT OF THIRD PARTY RIGHTS. IN NO EVENT SHALL THE AUTHORS OR COPYRIGHT HOLDERS BE LIABLE FOR ANY CLAIM, DAMAGES OR OTHER LIABILITY, WHETHER IN AN ACTION OF CONTRACT, TORT OR OTHERWISE, ARISING FROM, OUT OF OR IN CONNECTION WITH THE SOFTWARE OR THE USEOR OTHER DEALINGS IN THE SOFTWARE.

Except as contained in this notice, the name of a copyright holder shall not be used in advertising or otherwise to promote the sale, use or other dealings in this Software without prior written authorization of the copyright holder.

Microsoft Public License (Ms-PL)

Copyright (c) 2009 Wong Shao Voon

Copyright (c) 1998-2012 Glenn Randers-Pehrson

This license governs use of the accompanying software. If you use the software, you accept this license. If you do not accept the license, do not use the software.

1. Definitions

The terms "reproduce," "reproduction," "derivative works," and "distribution" have the same meaning here as under U.S. copyright law.

A "contribution" is the original software, or any additions or changes to the software.

A "contributor" is any person that distributes its contribution under this license.

"Licensed patents" are a contributor's patent claims that read directly on its contribution.

2. Grant of Rights

A. Copyright Grant- Subject to the terms of this license, including the license conditions and limitations in section 3, each contributor grants you a non-exclusive, worldwide, royalty-free copyright license to reproduce its contribution, prepare derivative works of its contribution, and distribute its contribution or any derivative works that you create.

B. Patent Grant- Subject to the terms of this license, including the license conditions and limitations in section 3, each contributor grants you a non-exclusive, worldwide, royalty-free license under its licensed patents to make, have made, use, sell, offer for sale, import, and/or otherwise dispose of its contribution in the software or derivative works of the contribution in the software.

3. Conditions and Limitations

A. No Trademark License- This license does not grant you rights to use any contributors' name, logo, or trademarks.

B. If you bring a patent claim against any contributor over patents that you claim are infringed by the software, your patent license from such contributor to the software ends automatically.

C. If you distribute any portion of the software, you must retain all copyright, patent, trademark, and attribution notices that are present in the software.

D. If you distribute any portion of the software in source code form, you may do so only under this license by including a complete copy of this license with your distribution. If you distribute any portion of the software in compiled or object code form, you may only do so under a license that complies with this license.

E. The software is licensed "as-is." You bear the risk of using it. The contributors give no express warranties, guarantees or conditions. You may have additional consumer rights under your local laws which this license cannot change. To the extent permitted under your local laws, the contributors exclude the implied warranties of merchantability, fitness for a particular purpose and non-infringement.

The Code Project Open License (CPOL) 1.02

Copyright (c) 2004..2007 Rob Groves

Preamble

This License governs Your use of the Work. This License is intended to allow developers to use the Source Code and Executable Files provided as part of the Work in any application in any form.

The main points subject to the terms of the License are:

- Source Code and Executable Files can be used in commercial applications;
- Source Code and Executable Files can be redistributed; and
- Source Code can be modified to create derivative works.
- No claim of suitability, guarantee, or any warranty whatsoever is provided. The software is provided "as-is".
- The Article accompanying the Work may not be distributed or republished without the Author's consent

This License is entered between You, the individual or other entity reading or otherwise making use of the Work licensed pursuant to this License and the individual or other entity which offers the Work under the terms of this License ("Author").

License

THE WORK (AS DEFINED BELOW) IS PROVIDED UNDER THE TERMS OF THIS CODE PROJECT OPEN LICENSE ("LICENSE"). THE WORK IS PROTECTED BY COPYRIGHT AND/OR OTHER APPLICABLE LAW. ANY USE OF THE WORK OTHER THAN AS AUTHORIZED UNDER THIS LICENSE OR COPYRIGHT LAW IS PROHIBITED.

BY EXERCISING ANY RIGHTS TO THE WORK PROVIDED HEREIN, YOU ACCEPT AND AGREE TO BE BOUND BY THE TERMS OF THIS LICENSE. THE AUTHOR GRANTS YOU THE RIGHTS CONTAINED HEREIN IN CONSIDERATION OF YOUR ACCEPTANCE OF SUCH TERMS AND CONDITIONS. IF YOU DO NOT AGREE TO ACCEPT AND BE BOUND BY THE TERMS OF THIS LICENSE, YOU CANNOT MAKE ANY USE OF THE WORK.

1. Definitions.

- a. **"Articles"** means, collectively, all articles written by Author which describes how the Source Code and Executable Files for the Work may be used by a user.
- b. **"Author"** means the individual or entity that offers the Work under the terms of this License.
- c. **"Derivative Work"** means a work based upon the Work or upon the Work and other pre-existing works.
- d. **"Executable Files"** refer to the executables, binary files, configuration and any required data files included in the Work.

e. **"Publisher"** means the provider of the website, magazine, CD-ROM, DVD or other medium from or by which the Work is obtained by You.

f. **"Source Code"** refers to the collection of source code and configuration files used to create the Executable Files.

g. **"Standard Version"** refers to such a Work if it has not been modified, or has been modified in accordance with the consent of the Author, such consent being in the full discretion of the Author.

h. **"Work"** refers to the collection of files distributed by the Publisher, including the Source Code, Executable Files, binaries, data files, documentation, whitepapers and the Articles.

i. **"You"** is you, an individual or entity wishing to use the Work and exercise your rights under this License.

2. **Fair Use/Fair Use Rights.** Nothing in this License is intended to reduce, limit, or restrict any rights arising from fair use, fair dealing, first sale or other limitations on the exclusive rights of the copyright owner under copyright law or other applicable laws.

3. **License Grant.** Subject to the terms and conditions of this License, the Author hereby grants You a worldwide, royalty-free, non-exclusive, perpetual (for the duration of the applicable copyright) license to exercise the rights in the Work as stated below:

- a. You may use the standard version of the Source Code or Executable Files in Your own applications.
- b. You may apply bug fixes, portability fixes and other modifications obtained from the Public Domain or from the Author. A Work modified in such a way shall still be considered the standard version and will be subject to this License.
- c. You may otherwise modify Your copy of this Work (excluding the Articles) in any way to create a Derivative Work, provided that You insert a prominent notice in each changed file stating how, when and where You changed that file.
- d. You may distribute the standard version of the Executable Files and Source Code or Derivative Work in aggregate with other (possibly commercial) programs as part of a larger (possibly commercial) software distribution.
- e. The Articles discussing the Work published in any form by the author may not be distributed or republished without the Author's consent. The author retains copyright to any such Articles. You may use the Executable Files and Source Code pursuant to this License but you may not repost or republish or otherwise distribute or make available the Articles, without the prior written consent of the Author.

Any subroutines or modules supplied by You and linked into the Source Code or Executable Files this Work shall not be considered part of this Work and will not be subject to the terms of this License.

4. **Patent License.** Subject to the terms and conditions of this License, each Author hereby grants to You a perpetual, worldwide, non-exclusive, no-charge, royalty-free, irrevocable (except as stated in this section) patent license to make, have made, use, import, and otherwise transfer the Work.

5. Restrictions. The license granted in Section 3 above is expressly made subject to and limited by the following restrictions:

- a. You agree not to remove any of the original copyright, patent, trademark, and attribution notices and associated disclaimers that may appear in the Source Code or Executable Files.
- b. You agree not to advertise or in any way imply that this Work is a product of Your own.
- c. The name of the Author may not be used to endorse or promote products derived from the Work without the prior written consent of the Author.
- d. You agree not to sell, lease, or rent any part of the Work. This does not restrict you from including the Work or any part of the Work inside a larger software distribution that itself is being sold. The Work by itself, though, cannot be sold, leased or rented.
- e. You may distribute the Executable Files and Source Code only under the terms of this License, and You must include a copy of, or the Uniform Resource Identifier for, this License with every copy of the Executable Files or Source Code You distribute and ensure that anyone receiving such Executable Files and Source Code agrees that the terms of this License apply to such Executable Files and/or Source Code. You may not offer or impose any terms on the Work that alter or restrict the terms of this License or the recipients' exercise of the rights granted hereunder. You may not sublicense the Work. You must keep intact all notices that refer to this License

and to the disclaimer of warranties. You may not distribute the Executable Files or Source Code with any technological measures that control access or use of the Work in a manner inconsistent with the terms of this License.

f. You agree not to use the Work for illegal, immoral or improper purposes, or on pages containing illegal, immoral or improper material. The Work is subject to applicable export laws. You agree to comply with all such laws and regulations that may apply to the Work after Your receipt of the Work.

6. **Representations, Warranties and Disclaimer.** THIS WORK IS PROVIDED "AS IS", "WHERE IS" AND "AS AVAILABLE", WITHOUT ANY EXPRESS OR IMPLIED WARRANTIES OR CONDITIONS OR GUARANTEES. YOU, THE USER, ASSUME ALL RISK IN ITS USE, INCLUDING COPYRIGHT INFRINGEMENT, PATENT INFRINGEMENT, SUITABILITY, ETC. AUTHOR EXPRESSLY DISCLAIMS ALL EXPRESS, IMPLIED OR STATUTORY WARRANTIES OR CONDITIONS, INCLUDING WITHOUT LIMITATION, WARRANTIES OR CONDITIONS OF MERCHANTABILITY, MERCHANTABLE QUALITY OR FITNESS FOR A PARTICULAR PURPOSE, OR ANY WARRANTY OF TITLE OR NON-INFRINGEMENT, OR THAT THE WORK (OR ANY PORTION THEREOF) IS CORRECT, USEFUL, BUG-FREE OR FREE OF VIRUSES. YOU MUST PASS THIS DISCLAIMER ON WHENEVER YOU DISTRIBUTE THE WORK OR DERIVATIVE WORKS.

7. **Indemnity.** You agree to defend, indemnify and hold harmless the Author and the Publisher from and against any claims, suits, losses, damages, liabilities, costs, and expenses (including reasonable legal or attorneys' fees) resulting from or relating to any use of the Work by You.

8. **Limitation on Liability.** EXCEPT TO THE EXTENT REQUIRED BY APPLICABLE LAW, IN NO EVENT WILL THE AUTHOR OR THE PUBLISHER BE LIABLE TO YOU ON ANY LEGAL THEORY FOR ANY SPECIAL, INCIDENTAL, CONSEQUENTIAL, PUNITIVE OR EXEMPLARY DAMAGES ARISING OUT OF THIS LICENSE OR THE USE OF THE WORK OR OTHERWISE, EVEN IF THE AUTHOR OR THE PUBLISHER HAS BEEN ADVISED OF THE POSSIBILITY OF SUCH DAMAGES.

9. Termination.

- a. This License and the rights granted hereunder will terminate automatically upon any breach by You of any term of this License. Individuals or entities who have received Derivative Works from You under this License, however, will not have their licenses terminated provided such individuals or entities remain in full compliance with those licenses. Sections 1, 2, 6, 7, 8, 9, 10 and 11 will survive any termination of this License.
- b. If You bring a copyright, trademark, patent or any other infringement claim against any contributor over infringements You claim are made by the Work, your License from such contributor to the Work ends automatically.
- c. Subject to the above terms and conditions, this License is perpetual (for the duration of the applicable copyright in the Work). Notwithstanding the above, the Author reserves the right to release the Work under different license terms or to stop distributing the Work at any time; provided, however that any such election will not serve to withdraw this License (or any other license that has been, or is required to be, granted under the terms of this License), and this License will continue in full force and effect unless terminated as stated above.

10. **Publisher.** The parties hereby confirm that the Publisher shall not, under any circumstances, be responsible for and shall not have any liability in respect of the subject matter of this License. The Publisher makes no warranty whatsoever in connection with the Work and shall not be liable to You or any party on any legal theory for any damages whatsoever, including without limitation any general, special, incidental or consequential damages arising in connection to this license. The Publisher reserves the right to cease making the Work available to You at any time without notice

11. Miscellaneous

- a. This License shall be governed by the laws of the location of the head office of the Author or if the Author is an individual, the laws of location of the principal place of residence of the Author.
- b. If any provision of this License is invalid or unenforceable under applicable law, it shall not affect the validity or enforceability of the remainder of the terms of this License, and without further action by the parties to this License, such provision shall be reformed to the minimum extent necessary to make such provision valid and enforceable.

c. No term or provision of this License shall be deemed waived and no breach consented to unless such waiver or consent shall be in writing and signed by the party to be charged with such waiver or consent.

d. This License constitutes the entire agreement between the parties with respect to the Work licensed herein. There are no understandings, agreements or representations with respect to the Work not specified herein. The Author shall not be bound by any additional provisions that may appear in any communication from You. This License may not be modified without the mutual written agreement of the Author and You.

The Independent JPEG Group's JPEG software

Copyright (C) 1991-1997, Thomas G. Lane.

README for release 6b of 27-Mar-1998

=====

This distribution contains the sixth public release of the Independent JPEG Group's free JPEG software. You are welcome to redistribute this software and to use it for any purpose, subject to the conditions under LEGAL ISSUES, below.

Serious users of this software (particularly those incorporating it into larger programs) should contact IJG at jpeg-info@uunet.uu.net to be added to our electronic mailing list. Mailing list members are notified of updates and have a chance to participate in technical discussions, etc.

This software is the work of Tom Lane, Philip Gladstone, Jim Boucher, Lee Crocker, Julian Minguiillon, Luis Ortiz, George Phillips, Davide Rossi, Guido Vollbeding, Ge' Weijers, and other members of the Independent JPEG Group.

IJG is not affiliated with the official ISO JPEG standards committee.

LEGAL ISSUES

=====

In plain English:

1. We don't promise that this software works. (But if you find any bugs, please let us know!)
2. You can use this software for whatever you want. You don't have to pay us.
3. You may not pretend that you wrote this software. If you use it in a program, you must acknowledge somewhere in your documentation that you've used the IJG code.

In legalese:

The authors make NO WARRANTY or representation, either express or implied, with respect to this software, its quality, accuracy, merchantability, or fitness for a particular purpose. This software is provided "AS IS", and you, its user, assume the entire risk as to its quality and accuracy.

This software is copyright (C) 1991-1998, Thomas G. Lane. All Rights Reserved except as specified below.

Permission is hereby granted to use, copy, modify, and distribute this software (or portions thereof) for any purpose, without fee, subject to these conditions:

(1) If any part of the source code for this software is distributed, then this README file must be included, with this copyright and no-warranty notice unaltered; and any additions, deletions, or changes to the original files must be clearly indicated in accompanying documentation.

(2) If only executable code is distributed, then the accompanying documentation must state that "this software is based in part on the work of the Independent JPEG Group".

(3) Permission for use of this software is granted only if the user accepts full responsibility for any undesirable consequences; the authors accept NO LIABILITY for damages of any kind.

These conditions apply to any software derived from or based on the IJG code, not just to the unmodified library. If you use our work, you ought to acknowledge us.

Permission is NOT granted for the use of any IJG author's name or company name in advertising or publicity relating to this software or products derived from it. This software may be referred to only as "the Independent JPEG Group's software".

We specifically permit and encourage the use of this software as the basis of commercial products, provided that all warranty or liability claims are assumed by the product vendor.

ansi2knr.c is included in this distribution by permission of L. Peter Deutsch, sole proprietor of its copyright holder, Aladdin Enterprises of Menlo Park, CA. ansi2knr.c is NOT covered by the above copyright and conditions, but instead by the usual distribution terms of the Free Software Foundation; principally, that you must include source code if you redistribute it. (See the file ansi2knr.c for full details.) However, since ansi2knr.c is not needed as part of any program generated from the IJG code, this does not limit you more than the foregoing paragraphs do.

The Unix configuration script "configure" was produced with GNU Autoconf. It is copyright by the Free Software Foundation but is freely distributable. The same holds for its supporting scripts (config.guess, config.sub, ltconfig, ltmain.sh). Another support script, install-sh, is copyright by M.I.T. but is also freely distributable.

It appears that the arithmetic coding option of the JPEG spec is covered by patents owned by IBM, AT&T, and Mitsubishi. Hence arithmetic coding cannot legally be used without obtaining one or more licenses. For this reason, support for arithmetic coding has been removed from the free JPEG software. (Since arithmetic coding provides only a marginal gain over the unpatented Huffman mode, it is unlikely that very many implementations will support it.) So far as we are aware, there are no patent restrictions on the remaining code.

The IJG distribution formerly included code to read and write GIF files. To avoid entanglement with the Unisys LZW patent, GIF reading support has been removed altogether, and the GIF writer has been simplified to produce "uncompressed GIFs". This technique does not use the LZW algorithm; the resulting GIF files are larger than usual, but are readable by all standard GIF decoders.

We are required to state that

"The Graphics Interchange Format(c) is the Copyright property of CompuServe Incorporated. GIF(sm) is a Service Mark property of CompuServe Incorporated."

RSA MD4 or MD5 Message-Digest Algorithm License

License to copy and use this software is granted provided that it is identified as the "RSA Data Security, Inc. MD4 or MD5 Message-Digest Algorithm" in all material mentioning or referencing this software or this function.

License is also granted to make and use derivative works provided that such works are identified as "derived from the RSA Data Security, Inc. MD4 or MD5 Message-Digest Algorithm" in all material mentioning or referencing the derived work.

RSA Data Security, Inc. makes no representations concerning either the merchantability of this software or the suitability of this software for any particular purpose. It is provided "as is" without express or implied warranty of any kind.

These notices must be retained in any copies of any part of this documentation and/or software.

The PHP License, version 3.01

Copyright (c) 1999 - 2006 The PHP Group. All rights reserved.

Redistribution and use in source and binary forms, with or without modification, is permitted provided that the following conditions are met:

1. Redistributions of source code must retain the above copyright notice, this list of conditions and the following disclaimer.
2. Redistributions in binary form must reproduce the above copyright notice, this list of conditions and the following disclaimer in the documentation and/or other materials provided with the distribution.
3. The name "PHP" must not be used to endorse or promote products derived from this software without prior written permission. For written permission, please contact group@php.net.
4. Products derived from this software may not be called "PHP", nor may "PHP" appear in their name, without prior written permission from group@php.net. You may indicate that your software works in conjunction with PHP by saying "Foo for PHP" instead of calling it "PHP Foo" or "phpfoo"
5. The PHP Group may publish revised and/or new versions of the license from time to time. Each version will be given a distinguishing version number. Once covered code has been published under a particular version of the license, you may always continue to use it under the terms of that version. You may also choose to use such covered code under the terms of any subsequent version of the license published by the PHP Group. No one other than the PHP Group has

the right to modify the terms applicable to covered code created under this License.

6. Redistributions of any form whatsoever must retain the following acknowledgment:

"This product includes PHP software, freely available from {http://www.php.net/software/}".

THIS SOFTWARE IS PROVIDED BY THE PHP DEVELOPMENT TEAM "AS IS" AND ANY EXPRESSED OR IMPLIED WARRANTIES, INCLUDING, BUT NOT LIMITED TO, THE IMPLIED WARRANTIES OF MERCHANTABILITY AND FITNESS FOR A PARTICULAR PURPOSE ARE DISCLAIMED. IN NO EVENT SHALL THE PHP DEVELOPMENT TEAM OR ITS CONTRIBUTORS BE LIABLE FOR ANY DIRECT, INDIRECT, INCIDENTAL, SPECIAL, EXEMPLARY, OR CONSEQUENTIAL DAMAGES (INCLUDING, BUT NOT LIMITED TO, PROCUREMENT OF SUBSTITUTE GOODS OR SERVICES; LOSS OF USE, DATA, OR PROFITS; OR BUSINESS INTERRUPTION) HOWEVER CAUSED AND ON ANY THEORY OF LIABILITY, WHETHER IN CONTRACT, STRICT LIABILITY, OR TORT (INCLUDING NEGLIGENCE OR OTHERWISE) ARISING IN ANY WAY OUT OF THE USE OF THIS SOFTWARE, EVEN IF ADVISED OF THE POSSIBILITY OF SUCH DAMAGE.

This software consists of voluntary contributions made by many individuals on behalf of the PHP Group.

The PHP Group can be contacted via Email at group@php.net.

For more information on the PHP Group and the PHP project, please see {http://www.php.net}.

PHP includes the Zend Engine, freely available at {http://www.zend.com}.

LICENSE ISSUES

=====

The OpenSSL toolkit stays under a dual license, i.e. both the conditions of the OpenSSL License and the original SSLeay license apply to the toolkit. See below for the actual license texts. Actually both licenses are BSD-style Open Source licenses. In case of any license issues related to OpenSSL please contact openssl-core@openssl.org.

OpenSSL License

Copyright (c) 1998-2008 The OpenSSL Project. All rights reserved.

Redistribution and use in source and binary forms, with or without modification, are permitted provided that the following conditions are met:

1. Redistributions of source code must retain the above copyright notice, this list of conditions and the following disclaimer.
2. Redistributions in binary form must reproduce the above copyright notice, this list of conditions and the following disclaimer in the documentation and/or other materials provided with the distribution.
3. All advertising materials mentioning features or use of this software must display the following acknowledgment:

"This product includes software developed by the OpenSSL Project for use in the OpenSSL Toolkit. (http://www.openssl.org)"
4. The names "OpenSSL Toolkit" and "OpenSSL Project" must not be used to endorse or promote products derived from this software without prior written permission. For written permission, please contact openssl-core@openssl.org.
5. Products derived from this software may not be called "OpenSSL" nor may "OpenSSL" appear in their names without prior written permission of the OpenSSL Project.
6. Redistributions of any form whatsoever must retain the following acknowledgment:

"This product includes software developed by the OpenSSL Project for use in the OpenSSL Toolkit (http://www.openssl.org/)"

THIS SOFTWARE IS PROVIDED BY THE OPENSSL PROJECT "AS IS" AND ANY EXPRESSED OR IMPLIED WARRANTIES, INCLUDING, BUT NOT LIMITED TO, THE IMPLIED WARRANTIES OF MERCHANTABILITY AND FITNESS FOR A PARTICULAR PURPOSE ARE DISCLAIMED. IN NO EVENT SHALL THE OPENSSL PROJECT OR ITS CONTRIBUTORS BE LIABLE FOR ANY DIRECT, INDIRECT, INCIDENTAL, SPECIAL, EXEMPLARY, OR CONSEQUENTIAL DAMAGES (INCLUDING, BUT NOT LIMITED TO, PROCUREMENT OF SUBSTITUTE GOODS OR SERVICES; LOSS OF USE, DATA, OR PROFITS; OR BUSINESS INTERRUPTION) HOWEVER CAUSED AND ON ANY THEORY OF

LIABILITY, WHETHER IN CONTRACT, STRICT LIABILITY, OR TORT (INCLUDING NEGLIGENCE OR OTHERWISE) ARISING IN ANY WAY OUT OF THE USE OF THIS SOFTWARE, EVEN IF ADVISED OF THE POSSIBILITY OF SUCH DAMAGE.

=====

This product includes cryptographic software written by Eric Young (eay@cryptsoft.com). This product includes software written by Tim Hudson (tjh@cryptsoft.com).

PCRE 5 LICENCE

PCRE is a library of functions to support regular expressions whose syntax and semantics are as close as possible to those of the Perl 5 language.

Release 5 of PCRE is distributed under the terms of the "BSD" licence, as specified below. The documentation for PCRE, supplied in the "doc" directory, is distributed under the same terms as the software itself.

Written by: Philip Hazel (ph10@cam.ac.uk)

University of Cambridge Computing Service,

Cambridge, England. Phone: +44 1223 334714.

Copyright (c) 1997-2004 University of Cambridge

All rights reserved.

Redistribution and use in source and binary forms, with or without modification, are permitted provided that the following conditions are met:

- Redistributions of source code must retain the above copyright notice, this list of conditions and the following disclaimer.
- Redistributions in binary form must reproduce the above copyright notice, this list of conditions and the following disclaimer in the documentation and/or other materials provided with the distribution.
- Neither the name of the University of Cambridge nor the names of its contributors may be used to endorse or promote products derived from this software without specific prior written permission.

THIS SOFTWARE IS PROVIDED BY THE COPYRIGHT HOLDERS AND CONTRIBUTORS "AS IS" AND ANY EXPRESS OR IMPLIED WARRANTIES, INCLUDING, BUT NOT LIMITED TO, THE IMPLIED WARRANTIES OF MERCHANTABILITY AND FITNESS FOR A PARTICULAR PURPOSE ARE DISCLAIMED. IN NO EVENT SHALL THE COPYRIGHT OWNER OR CONTRIBUTORS BE LIABLE FOR ANY DIRECT, INDIRECT, INCIDENTAL, SPECIAL, EXEMPLARY, OR CONSEQUENTIAL DAMAGES (INCLUDING, BUT NOT LIMITED TO, PROCUREMENT OF SUBSTITUTE GOODS OR SERVICES; LOSS OF USE, DATA, OR PROFITS; OR BUSINESS INTERRUPTION) HOWEVER CAUSED AND ON ANY THEORY OF LIABILITY, WHETHER IN CONTRACT, STRICT LIABILITY, OR TORT (INCLUDING NEGLIGENCE OR OTHERWISE) ARISING IN ANY WAY OUT OF THE USE OF THIS SOFTWARE, EVEN IF ADVISED OF THE POSSIBILITY OF SUCH DAMAGE.

NTP License

This file is automatically generated from html/copyright.htm

Copyright Notice

[sheepb.jpg] "Clone me," says Dolly sheepishly

The following copyright notice applies to all files collectively called the Network Time Protocol Version 4 Distribution. Unless specifically declared otherwise in an individual file, this notice applies as if the text was explicitly included in the file.

Copyright (c) David L. Mills 1992-2001

Permission to use, copy, modify, and distribute this software and its documentation for any purpose and without fee is hereby granted, provided that the above copyright notice appears in all copies and that both the copyright notice and this permission notice appear in supporting documentation, and that the name University of Delaware not be used in advertising or publicity pertaining to distribution of the software without specific, written prior permission. The University of Delaware makes no representations about the suitability this software for any purpose. It is provided "as is" without express or implied warranty.

The following individuals contributed in part to the Network Time Protocol Distribution Version 4 and are acknowledged as authors of this work.

- [1]Mark Andrews <marka@syd.dms.csiro.au> Leitch atomic clock controller
- [2]Bernd Altmeier <altmeier@atsoft.de> hopf Elektronik serial line and PCI-bus devices
- [3]Viraj Bais <vbais@mailman1.intel.com> and [4]Clayton Kirkwood <kirkwood@striderfm.intel.com> port to WindowsNT 3.5
- [5]Michael Barone <michael.barone@lmco.com> GPSVME fixes
- [6]Karl Berry <karl@owl.HQ.ileaf.com> syslog to file option
- [7]Greg Brackley <greg.brackley@bigfoot.com> Major rework of WINNT port. Clean up recvbuf and iosignal code into separate modules.
- [8]Marc Brett <Marc.Brett@westgeo.com> Magnavox GPS clock driver
- [9]Piete Brooks <Piete.Brooks@cl.cam.ac.uk> MSF clock driver, Trimble PARSE support
- [10]Reg Clemens <reg@dwf.com> Oncore driver (Current maintainer)
- [11]Steve Clift <clift@ml.csiro.au> OMEGA clock driver
- [12]Casey Crellin <casey@csc.co.za> vxWorks (Tornado) port and help with target configuration
- [13]Sven Dietrich <sven_dietrich@trimble.com> Palisade reference clock driver, NT adj. residuals, integrated Greg's Winnt port.
- [14]John A. Dundas III <dundas@salt.jpl.nasa.gov> Apple A/UX port
- [15]Torsten Duwe <duwe@immd4.informatik.uni-erlangen.de> Linux port
- [16]Dennis Ferguson <dennis@mrbill.canet.ca> foundation code for NTP Version 2 as specified in RFC-1119
- [17]Glenn Hollinger <glenn@herald.usask.ca> GOES clock driver
- [18]Mike Iglesias <iglesias@uci.edu> DEC Alpha port
- [19]Jim Jagielski <jim@jagubox.gsfc.nasa.gov> A/UX port
- [20]Jeff Johnson <jbj@chatham.usdesign.com> massive prototyping overhaul
- [21]Hans Lambermont <Hans.Lambermont@nl.origin-it.com> or [22]<H.Lambermont@chello.nl> ntpswEEP
- [23]Poul-Henning Kamp <phk@FreeBSD.ORG> Oncore driver (Original author)
- [24]Frank Kardel [25]<Frank.Kardel@informatik.uni-erlangen.de> PARSE <GENERIC> driver (14 reference clocks), STREAMS modules for PARSE, support scripts, syslog cleanup
- [26]William L. Jones <jones@hermes.chpc.utexas.edu> RS/6000 AIX modifications, HPUX modifications
- [27]Dave Katz <dkatz@cisco.com> RS/6000 AIX port
- [28]Craig Leres <leres@ee.lbl.gov> 4.4BSD port, ppsclock, Magnavox GPS clock driver
- [29]George Lindholm <lindholm@ucs.ubc.ca> SunOS 5.1 port
- [30]Louis A. Mamakos <louie@ni.umd.edu> MD5-based authentication
- [31]Lars H. Mathiesen <thorinn@diku.dk> adaptation of foundation code for Version 3 as specified in RFC-1305
- [32]David L. Mills <mills@udel.edu> Version 4 foundation: clock discipline, authentication, precision kernel; clock drivers: Spectracom, Austron, Arbiter, Heath, ATOM, ACTS, KSI/Odetics; audio clock drivers: CHU, WWW/H, IRIG
- [33]Wolfgang Moeller <moeller@gwdgv1.dnet.gwdg.de> VMS port
- [34]Jeffrey Mogul <mogul@pa.dec.com> ntptrace utility
- [35]Tom Moore <tmoore@fiemel.daytonoh.ncr.com> i386 svr4 port
- [36]Kamal A Mostafa <kamal@whence.com> SCO OpenServer port
- [37]Derek Mulcahy <derek@toybox.demon.co.uk> and [38]Damon Hart-Davis <d@hd.org> ARCRON MSF clock driver
- [39]Rainer Pruy <Rainer.Pruy@informatik.uni-erlangen.de> monitoring/trap scripts, statistics file handling
- [40]Dirce Richards <dirce@zk3.dec.com> Digital UNIX V4.0 port
- [41]Wilfredo Sánchez <wsanchez@apple.com> added support for NetInfo
- [42]Nick Sayer <mrapple@quack.kfu.com> SunOS streams modules

- [43]Jack Sasportas <jack@innovativeinternet.com> Saved a Lot of space on the stuff in the html/pic/ subdirectory
- [44]Ray Schnitzler <schnitz@unipress.com> Unixware1 port
- [45]Michael Shields <shields@tembel.org> USNO clock driver
- [46]Jeff Steinman <jss@pebbles.jpl.nasa.gov> Datum PTS clock driver
- [47]Harlan Stenn <harlan@pfcs.com> GNU automake/autoconfigure makeover, various other bits (see the Changelog)
- [48]Kenneth Stone <ken@sdd.hp.com> HP-UX port
- [49]Ajit Thyagarajan <ajit@ee.udel.edu> IP multicast/anycast support
- [50]Tomoaki TSURUOKA <tsuruoka@nc.fukuoka-u.ac.jp> TRAK clock driver
- [51]Paul A Vixie <vixie@vix.com> TrueTime GPS driver, generic TrueTime clock driver
- [52]Ulrich Windl <Ulrich.Windl@rz.uni-regensburg.de> corrected and validated HTML documents according to the HTML DTD
- [53]gif
- [54]David L. Mills <mills@udel.edu>

References

- mailto:marka@syd.dms.csiro.au
- mailto:altmeier@atsoft.de
- mailto:vbais@mailman1.intel.com
- mailto:kirkwood@striderfm.intel.com
- mailto:michael.barone@lmco.com
- mailto:karl@owl.HQ.ileaf.com
- mailto:greg.brackley@bigfoot.com
- mailto:Marc.Brett@westgeo.com
- mailto:Piete.Brooks@cl.cam.ac.uk
- mailto:reg@dwf.com
- mailto:clift@ml.csiro.au
- mailto:casey@csc.co.za
- mailto:Sven_Dietrich@trimble.COM
- mailto:dundas@salt.jpl.nasa.gov
- mailto:duwe@immd4.informatik.uni-erlangen.de
- mailto:dennis@mrbill.canet.ca
- mailto:glenn@herald.usask.ca
- mailto:iglesias@uci.edu
- mailto:jagubox.gsfc.nasa.gov
- mailto:jbj@chatham.usdesign.com
- mailto:Hans.Lambermont@nl.origin-it.comv
- mailto:H.Lambermont@chello.nl
- mailto:phk@FreeBSD.ORG
- http://www4.informatik.uni-erlangen.de/kardel
- mailto:Frank.Kardel@informatik.uni-erlangen.de
- mailto:jones@hermes.chpc.utexas.edu
- mailto:dkatz@cisco.com
- mailto:leres@ee.lbl.gov
- mailto:lindholm@ucs.ubc.ca
- mailto:louie@ni.umd.edu
- mailto:thorinn@diku.dk
- mailto:mills@udel.edu
- mailto:moeller@gwdgv1.dnet.gwdg.de
- mailto:mogul@pa.dec.com
- mailto:tmoore@fiemel.daytonoh.ncr.com
- mailto:kamal@whence.com
- mailto:derek@toybox.demon.co.uk
- mailto:d@hd.org
- mailto:Rainer.Pruy@informatik.uni-erlangen.de
- mailto:dirce@zk3.dec.com
- mailto:wsanchez@apple.com
- mailto:mrapple@quack.kfu.com

- mailto:jack@innovativeinternet.com
- mailto:schnitz@unipress.com
- mailto:shields@tembel.org
- mailto:pebbles.jpl.nasa.gov
- mailto:harlan@pfcs.com
- mailto:ken@sdd.hp.com
- mailto:ajit@ee.udel.edu
- mailto:tsuruoka@nc.fukuoka-u.ac.jp
- mailto:vixie@vix.com
- mailto:Ulrich.Windl@rz.uni-regensburg.de
- file://localhost/backroom/ntp-stable/html/index.htm
- mailto:mills@udel.edu

CodeIgniter License Agreement

Copyright (c) 2008 - 2009, EllisLab, Inc.

All rights reserved.

This license is a legal agreement between you and EllisLab Inc. for the use of CodeIgniter Software (the "Software"). By obtaining the Software you agree to comply with the terms and conditions of this license.

Permitted Use

You are permitted to use, copy, modify, and distribute the Software and its documentation, with or without modification, for any purpose, provided that the following conditions are met:

- A copy of this license agreement must be included with the distribution.
- Redistributions of source code must retain the above copyright notice in all source code files.
- Redistributions in binary form must reproduce the above copyright notice in the documentation and/or other materials provided with the distribution.
- Any files that have been modified must carry notices stating the nature of the change and the names of those who changed them.
- Products derived from the Software must include an acknowledgment that they are derived from CodeIgniter in their documentation and/or other materials provided with the distribution.
- Products derived from the Software may not be called "CodeIgniter", nor may "CodeIgniter" appear in their name, without prior written permission from EllisLab, Inc.

Indemnity

You agree to indemnify and hold harmless the authors of the Software and any contributors for any direct, indirect, incidental, or consequential third-party claims, actions or suits, as well as any related expenses, liabilities, damages, settlements or fees arising from your use or misuse of the Software, or a violation of any terms of this license.

Disclaimer of Warranty

THE SOFTWARE IS PROVIDED "AS IS", WITHOUT WARRANTY OF ANY KIND, EXPRESSED OR IMPLIED, INCLUDING, BUT NOT LIMITED TO, WARRANTIES OF QUALITY, PERFORMANCE, NON-INFRINGEMENT, MERCHANTABILITY, OR FITNESS FOR A PARTICULAR PURPOSE.

Limitations of Liability

YOU ASSUME ALL RISK ASSOCIATED WITH THE INSTALLATION AND USE OF THE SOFTWARE. IN NO EVENT SHALL THE AUTHORS OR COPYRIGHT HOLDERS OF THE SOFTWARE BE LIABLE FOR CLAIMS, DAMAGES OR OTHER LIABILITY ARISING FROM, OUT OF, OR IN CONNECTION WITH THE SOFTWARE. LICENSE HOLDERS ARE SOLELY RESPONSIBLE FOR DETERMINING THE APPROPRIATENESS OF USE AND ASSUME ALL RISKS ASSOCIATED WITH ITS USE, INCLUDING BUT NOT LIMITED TO THE RISKS OF PROGRAM ERRORS, DAMAGE TO EQUIPMENT, LOSS OF DATA OR SOFTWARE PROGRAMS, OR UNAVAILABILITY OR INTERRUPTION OF OPERATIONS.

GLUT for Win32 License

The OpenGL Utility Toolkit distribution for Win32 (Windows NT & Windows 95) contains source code modified from the original source code for GLUT version 3.3 which was developed by Mark J. Kilgard. The original source code for GLUT is Copyright 1997 by Mark J. Kilgard.

GLUT for Win32 is Copyright 1997 by Nate Robins and is not in the public domain, but it is freely distributable without licensing fees.

It is provided without guarantee or warrantee expressed or implied.

It was ported with the permission of Mark J. Kilgard by Nate Robins.

THIS SOURCE CODE IS PROVIDED "AS IS" WITHOUT WARRANTY OF ANY KIND, EITHER EXPRESS OR IMPLIED, INCLUDING, BUT NOT LIMITED TO, THE IMPLIED WARRANTIES OR MERCHANTABILITY OR FITNESS FOR A PARTICULAR PURPOSE.

OpenGL (R) is a registered trademark of Silicon Graphics, Inc.

ISC License

Copyright (c) 2004-2013 by Internet Systems Consortium, Inc. ("ISC")

Copyright (c) 1995-2003 by Internet Software Consortium

Permission to use, copy, modify, and distribute this software for any purpose with or without fee is hereby granted, provided that the above copyright notice and this permission notice appear in all copies.

THE SOFTWARE IS PROVIDED "AS IS" AND ISC DISCLAIMS ALL WARRANTIES WITH REGARD TO THIS SOFTWARE INCLUDING ALL IMPLIED WARRANTIES OF MERCHANTABILITY AND FITNESS. IN NO EVENT SHALL ISC BE LIABLE FOR ANY SPECIAL, DIRECT, INDIRECT, OR CONSEQUENTIAL DAMAGES OR ANY DAMAGES WHATSOEVER RESULTING FROM LOSS OF USE, DATA OR PROFITS, WHETHER IN AN ACTION OF CONTRACT, NEGLIGENCE OR OTHER TORTIOUS ACTION, ARISING OUT OF OR IN CONNECTION WITH THE USE OR PERFORMANCE OF THIS SOFTWARE.

Internet Systems Consortium, Inc.
950 Charter Street
Redwood City, CA 94063
<info@isc.org>
<https://www.isc.org/>

Brian Gladman Alternate License

Copyright (c) 2003, 2010 Brian Gladman, Worcester, UK. All rights reserved.

LICENSE TERMS

The free distribution and use of this software in both source and binary form is allowed (with or without changes) provided that:

- distributions of this source code include the above copyright notice, this list of conditions and the following disclaimer;
- distributions in binary form include the above copyright notice, this list of conditions and the following disclaimer in the documentation and/or other associated materials;
- the copyright holder's name is not used to endorse products built using this software without specific written permission.

ALTERNATIVELY, provided that this notice is retained in full, this product may be distributed under the terms of the GNU General Public License (GPL), in which case the provisions of the GPL apply INSTEAD OF those given above.

DISCLAIMER

This software is provided 'as is' with no explicit or implied warranties in respect of its properties, including, but not limited to, correctness and/or fitness for purpose.



Hanwha Techwin cares for the environment at all product manufacturing stages, and is taking measures to provide customers with more environmentally friendly products.

The Eco mark represents Hanwha Techwin's devotion to creating environmentally friendly products, and indicates that the product satisfies the EU RoHS Directive.

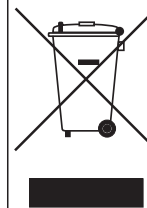

Correct Disposal of This Product (Waste Electrical & Electronic Equipment)

(Applicable in the European Union and other European countries with separate collection systems)

This marking on the product, accessories or literature indicates that the product and its electronic accessories (e.g. charger, headset, USB cable) should not be disposed of with other household waste at the end of their working life. To prevent possible harm to the environment or human health from uncontrolled waste disposal, please separate these items from other types of waste and recycle them responsibly to promote the sustainable reuse of material resources.

Household users should contact either the retailer where they purchased this product, or their local government office, for details of where and how they can take these items for environmentally safe recycling.

Business users should contact their supplier and check the terms and conditions of the purchase contract. This product and its electronic accessories should not be mixed with other commercial wastes for disposal.



Correct disposal of batteries in this product

(Applicable in the European Union and other European countries with separate battery return systems.)

This marking on the battery, manual or packaging indicates that the batteries in this product should not be disposed of with other household waste at the end of their working life. Where marked, the chemical symbols Hg, Cd or Pb indicate that the battery contains mercury, cadmium or lead above the reference levels in EC Directive 2006/66. If batteries are not properly disposed of, these substances can cause harm to human health or the environment.

To protect natural resources and to promote material reuse, please separate batteries from other types of waste and recycle them through your local, free battery return system.

Head Office

6, Pangyo-ro 319 beon-gil, Bundang-gu, Seongnam-si,
Gyeonggi-do, 463-400 Rep. of KOREA

Tel : +82.70.7147.8753 Fax : +82.31.8018.3740

www.hanwha-security.com

Hanwha Techwin America

500 Frank W. Burr Blvd. Suite 43 Teaneck, NJ 07666

Toll Free +1.877.213.1222 Direct +1.201.325.6920

Fax +1.201.373.0124

www.hanwha-security.com

Hanwha Techwin Europe

Heriot House, Heriot Road, Chertsey, Surrey, KT16 9DT, United Kingdom

Tel +44.1932.57.8100 Fax +44.1932.57.8101

www.hanwha-security.eu
