

**WISENET**

# **4/16 CHANNEL NETWORK VIDEO ENCODER**

User Manual

SPE-410/1610



# 4/16 Channel Network Video Encoder

## User Manual

---

### Copyright

©2019 Hanwha Techwin Co., Ltd. All rights reserved.

### Trademark

Each of trademarks herein is registered. The name of this product and other trademarks mentioned in this manual are the registered trademark of their respective company.

### Restriction

Copyright of this document is reserved. Under no circumstances, this document shall be reproduced, distributed or changed, partially or wholly, without formal authorization.

### Disclaimer

Hanwha Techwin makes the best to verify the integrity and correctness of the contents in this document, but no formal guarantee shall be provided. Use of this document and the subsequent results shall be entirely on the user's own responsibility. Hanwha Techwin reserves the right to change the contents of this document without prior notice.

❖ Design and specifications are subject to change without prior notice.

❖ The initial administrator ID is "admin" and the password should be set when logging in for the first time.

Please change your password every three months to safely protect personal information and to prevent the damage of the information theft.

Please, take note that it's a user's responsibility for the security and any other problems caused by mismanaging a password.

## IMPORTANT SAFETY INSTRUCTIONS

1. Read these instructions.
2. Keep these instructions.
3. Heed all warnings.
4. Follow all instructions.
5. Do not use this apparatus near water.
6. Clean the contaminated area on the product surface with a soft, dry cloth or a damp cloth. (Do not use a detergent or cosmetic products that contain alcohol, solvents or surfactants or oil constituents as they may deform or cause damage to the product.)
7. Do not block any ventilation openings, Install in accordance with the manufacturer's instructions.
8. Do not install near any heat sources such as radiators, heat registers, stoves, or other apparatus (including amplifiers) that produce heat.
9. Do not defeat the safety purpose of the polarized or grounding-type plug. A polarized plug has two blades with one wider than the other. A grounding type plug has two blades and a third grounding prong. The wide blade or the third prong are provided for your safety. If the provided plug does not fit into your outlet, consult an electrician for replacement of the obsolete outlet.
10. Protect the power cord from being walked on or pinched particularly at plugs, convenience receptacles, and the point where they exit from the apparatus.
11. Only use attachments/ accessories specified by the manufacturer.
12. Use only with the cart, stand, tripod, bracket, or table specified by the manufacturer, or sold with the apparatus. When a cart is used, use caution when moving the cart/ apparatus combination to avoid injury from tip-over.
13. Unplug this apparatus during lighting storms or when unused for long periods of time.
14. Refer all servicing to qualified service personnel. Servicing is required when the apparatus has been damaged in any way, such as power-supply cord or plug is damaged, liquid has been spilled or objects have fallen into the apparatus, the apparatus has been exposed to rain or moisture, does not operate normally, or has been dropped.
15. This product is intended to be supplied by a Listed Power Supply Unit marked "Class 2" or "LPS" and rated 12 Vdc, min. 0.8 A or PoE(37V ~57V), min. 0.28 A. (SPE-410)
16. If you use excessive force when installing the product, the encoder may be damaged and malfunction. If you forcibly install the product using non-compliant tools, the product may be damaged.
17. Do not install the product in a place where chemical substances or oil mist exists or may be generated. As edible oils such as soybean oil may damage or warp the product, do not install the product in the kitchen or near the kitchen table.  
This may cause damage to the product.
18. When installing the product, be careful not to allow the surface of the product to be stained with chemical substance.  
Some chemical solvents such as cleaner or adhesives may cause serious damage to the product's surface.
19. If you install/disassemble the product in a manner that has not been recommended, the production functions/ performance may not be guaranteed.  
Install the product by referring to "Installation & connection" in the user manual.
20. Installing or using the product in water can cause serious damage to the product.



## WARNING

TO REDUCE THE RISK OF FIRE OR ELECTRIC SHOCK, DO NOT EXPOSE THIS PRODUCT TO RAIN OR MOISTURE. DO NOT INSERT ANY METALLIC OBJECT THROUGH THE VENTILATION GRILLS OR OTHER OPENINGS ON THE EQUIPMENT.

Apparatus shall not be exposed to dripping or splashing and that no objects filled with liquids, such as vases, shall be placed on the apparatus.

To prevent injury, this apparatus must be securely attached to the Wall/ceiling in accordance with the installation instructions.

## CAUTION

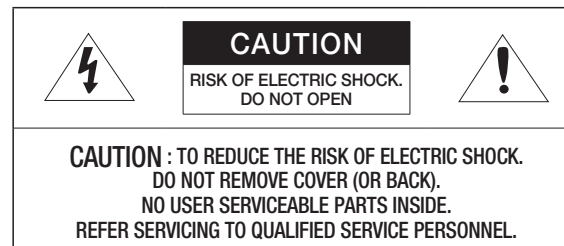

## EXPLANATION OF GRAPHICAL SYMBOLS



The lightning flash with arrowhead symbol, within an equilateral triangle, is intended to alert the user to the presence of "dangerous voltage" within the product's enclosure that may be of sufficient magnitude to constitute a risk of electric shock to persons.



The exclamation point within an equilateral triangle is intended to alert the user to the presence of important operating and maintenance (servicing) instructions in the literature accompanying the product.

## Class I construction

An apparatus with CLASS I construction shall be connected to a MAINS socket outlet with a protective earthing connection.

## Battery

Batteries(battery pack or batteries installed) shall not be exposed to excessive heat such as sunshine, fire or the like.

## Disconnection Device

Disconnect the main plug from the apparatus, if it's defected. And please call a repair man in your location.

**When used outside of the U.S., it may be used HAR code with fittings of an approved agency is employed.**

## CAUTION

RISK OF EXPLOSION IF BATTERY IS REPLACED BY AN INCORRECT TYPE.  
DISPOSE OF USED BATTERIES ACCORDING TO THE INSTRUCTIONS.

## ATTENTION

IL Y A RISQUE D'EXPLOSION SI LA BATTERIE EST REMPLACÉE PAR UNE BATTERIE DE TYPE INCORRECT.  
METTRE AU REBUT LES BATTERIES USAGÉES CONFORMÉMENT AUX INSTRUCTIONS.

These servicing instructions are for use by qualified service personnel only.

To reduce the risk of electric shock do not perform any servicing other than that contained in the operating instructions unless you are qualified to do so.

The HDMI out terminal of the product is provided for easier installation, and is not recommended for monitoring purposes.

Please use the input power with just one encoder and other devices must not be connected.

**The ITE is to be connected only to PoE networks without routing to the outside plant.**

**The wired LAN hub providing power over the Ethernet (PoE) in accordance with IEEE 802-3af shall be a UL Listed device with the output evaluated as a Limited Power Source as defined in UL60950-1.**

**Unit is intended for installation in a Network Environment 0 as defined in IEC TR 62102. As such, associated Ethernet wiring shall be limited to inside the building.**

Please read the following recommended safety precautions carefully.

- Do not place this apparatus on an uneven surface.
- Do not install on a surface where it is exposed to direct sunlight, near heating equipment or heavy cold area.
- Do not place this apparatus near conductive material.
- Do not attempt to service this apparatus yourself.
- Do not place a glass of water on the product.
- Do not install near any magnetic sources.
- Do not block any ventilation openings.
- Do not place heavy items on the product.
- Please wear protective gloves when installing/removing the encoder.  
The high temperature of the product surface may cause a burn.

User's Manual is a guidance book for how to use the products.

The meaning of the symbols are shown below.

- Reference : In case of providing information for helping of product's usages
  - Notice : If there's any possibility to occur any damages for the goods and human caused by not following the instruction
- ※ Please read this manual for the safety before using of goods and keep it in the safe place.

## BEFORE START

---

This manual provides operational information necessary for using the product and contains a description about each component part and its function as well as menu or network settings.

You have to keep in mind the following notices :

- Hanwha Techwin retains the copyright on this manual.
- This manual cannot be copied without Hanwha Techwin's prior written approval.
- We are not liable for any or all losses to the product incurred by your use of non-standard product or violation of instructions mentioned in this manual.
- Prior to opening the case, please consult a qualified technician first. Whenever this is needed power must be removed from the unit.

### Warning

---

#### Battery

It is essential that when changing the battery in the unit, the replacement battery must be of the same type otherwise there may be a possibility of an explosion.

The following are the specifications of the battery you are using now.

- Normal voltage : 3V
- Normal capacity : 220mAh
- Discharge Current : 0.2mA
- Operating temperature : -30°C ~ +60°C (-22°F ~ +140°F)

#### Operating Temperature

The guaranteed operating temperature range of this product is

SPE-1610 : -10°C ~ +45°C (14°F ~ 113°F) (-10°C ~ +40°C (14°F ~ 104°F), When installing Rack)

SPE-410 : -10°C ~ 50°C (14°F ~ 122°F).

This product may not work properly if you run right after a long period of storage at a temperature below the guaranteed one.

Prior to using a device that has been stored for a long period in low temperatures, allow the product to stand at room temperature for a period.

#### Security Precautions

The default administrator ID is "admin", and the password must be set when the user log in at the first time.

To prevent from your personal information being exposed, please change your password every 3 months.

Note that the security and other related issues caused by careless management of password shall be in the charge of the user.

**CONTENTS**

**OVERVIEW**

3

3	Important Safety Instructions
5	Before Start
7	Product Features
7	Recommended PC Specifications
8	Package Contents
9	Part Names and Functions (Front)
10	Part Names and Functions (Rear)

**INSTALLATION & CONNECTION**

11

11	Checking the installation environment
11	Rack Installation
12	Connecting with other Device

**NETWORK CONNECTION AND SETUP**

16

16	Connecting to Network through Ethernet (10/100/1000BaseT)
16	Connecting the encoder Directly to a DHCP Based DSL/Cable Modem
17	Connecting to Network through PPPoE
17	Connecting to the Network using the router
18	Buttons used in IP Installer
18	Static IP Setup
20	Dynamic IP Setup
20	Port Range Forward (Port Mapping) Setup
21	Connecting to the encoder from a Shared Local PC
21	Connecting to the encoder from a Remote PC via the Internet

**WEB VIEWER**

22

22	Connecting to the encoder
23	Password setting
23	Login
23	Using the Live Screen

**SETUP SCREEN**

26

26	Setup
26	Basic Setup
30	PTZ setup
31	Video & Audio setup
32	Network Setup
36	Event Setup
39	Configure analysis settings
40	System Setup

**APPENDIX**

42

42	Specification
43	Detailed supported specifications of the Web viewer
43	Device Type setup guide
44	Product Overview
45	Troubleshooting
46	Open Source Announcement

## PRODUCT FEATURES

---

This product can output videos of different resolutions and quality levels to different codecs at the same time, and provides an environment that can be monitored from a remote PC through a network.

- Provides a convenient viewer
- Video input terminals for 4/16 channels
- Supports various resolutions via the network
  - NTSC : 2560x1440, 1920x1080, 1280x720, 928x480, 704x480, 928x240, 704x240, 352x240
  - PAL : 2560x1440, 1920x1080, 1280x720, 928x576, 704x576, 928x288, 704x288, 352x288
- Alarm Interface
- Remote Monitoring function by Network Viewer, Smart Viewer and Mobile Viewer
- Supports coaxial and RS-485 protocols
- Tampering Detection
- ONVIF Compliance



## RECOMMENDED PC SPECIFICATIONS

---

- CPU : Intel(R) Core(TM) i7 3.4 GHz or higher
- RAM : 8G or higher
- Supported OS : Windows, Mac OS X
- Supported web browsers : Google Chrome, MS Edge, MS IE, Firefox (Windows 64bit only), Apple Safari (Mac OS X only)







Please see the appendix for detailed information on verified OS and browsers  
Some functions may be restricted even in supported browsers.

## PACKAGE CONTENTS

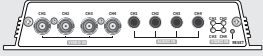







Please unwrap the product, and place the product on a flat place or in the place to be installed.  
Please check the following contents are included in addition to the main unit.

-  ■ The appearance of the components may differ from the image shown.
- Accessory category and quantity may differ depending on sales region.

### SPE-410

		
Network Video Encoder	Power Terminal Block	Warranty card (Optional)
		
User Manual or Quick Manual	Tapping Screw	Terminal Block (15 pin)

### SPE-1610

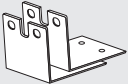
		
Network Video Encoder	Power Adapter	Power Cord
		
Warranty card (Optional)	User Manual or Quick Manual	Terminal Block (8 pin)
		
Terminal Block (10 pin)	Bracket Fixing Screw	Bracket Rack



## PART NAMES AND FUNCTIONS (FRONT)

### SPE-410

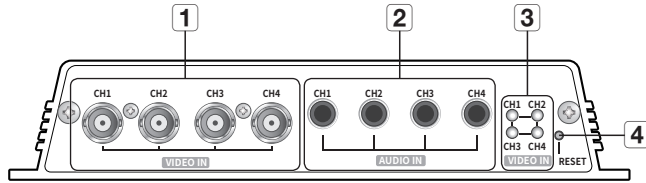

Part Names	Functions
<b>1</b> Video input	This is the video signal input terminal (BNC type).
<b>2</b> Audio input	This is the audio signal input terminal (RCA jack) and the optional audio extension cable jack.
<b>3</b> Video input status indicator	Displays the operation status of each video input channel.
<b>4</b> Initialization	This button is used to reset the encoder settings to their factory defaults. Press and hold for about 5 seconds to reboot. <b>!</b> When the encoder is initialized, the network setting is changed in order to use DHCP. If there is no DHCP server in the network, you can use the IP installer program to reconfigure the basic network settings (IP Address, Subnet Mask, Gateway, etc.).

### SPE-1610

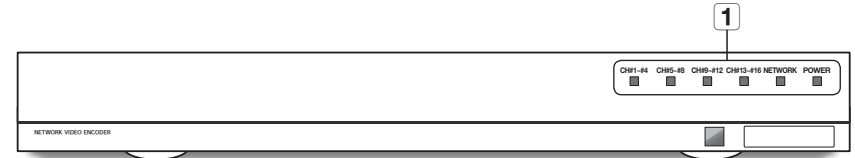

Part Names	Functions
<b>1</b> LED lamp	<p><b>CH#1~#4</b> : Video input channels.</p> <ul style="list-style-type: none"> <li>The light turns off only when all four video signals are not connected.</li> </ul> <p><b>CH#5~#8</b> : Video input channels.</p> <ul style="list-style-type: none"> <li>The light turns off only when all four video signals are not connected.</li> </ul> <p><b>CH#9~#12</b> : Video input channels.</p> <ul style="list-style-type: none"> <li>The light turns off only when all four video signals are not connected.</li> </ul> <p><b>CH#13~#16</b> : Video input channels.</p> <ul style="list-style-type: none"> <li>The light turns off only when all four video signals are not connected.</li> </ul> <p><b>NETWORK</b> : Displays the network connection status and the data transmission status.</p> <p><b>POWER</b> : Displays the power ON/OFF status.</p>

## PART NAMES AND FUNCTIONS (REAR)

### SPE-410

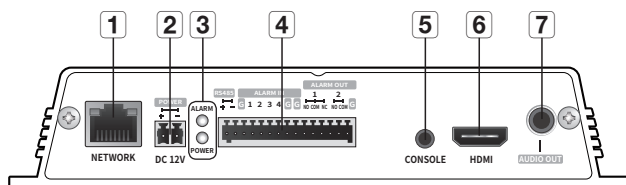

Part Names	Functions
<b>1</b> Network connection	This is a terminal that connects to the network through PoE or Ethernet cable.
<b>2</b> DC 12V	This is a network video encoder power connection terminal.
<b>3</b> LED lamp	ALARM : Lights up when an event occurs. POWER : Displays the power ON/OFF status.
<b>4</b> I/O terminal * NVR compatibility is under preparation.	RS485: Used for RS-485 communication. ALARM IN: Alarm input terminal. (1 - 4 channels) ALARM OUT: Alarm output terminal. (1 - 2 channels)
<b>5</b> CONSOLE	This is the console connection terminal.
<b>6</b> HDMI video output	This is the terminal that is used to check the test video. You can check the test video by connecting to the portable display using the HDMI cable. ■ You can view the video in 4 split screens. Only FHD video is supported.
<b>7</b> Audio output	This is the video signal output terminal (RCA jack).

 ■ [CONSOLE] is designed for the service repair purpose only.

### SPE-1610

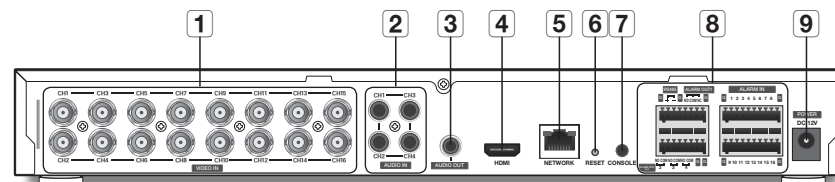

Part Names	Functions
<b>1</b> Video input	This is the video signal input terminal (BNC type).
<b>2</b> Audio input	This is the audio signal input terminal (RCA jack) and the optional audio extension cable jack.
<b>3</b> Audio output	This is the video signal output terminal (RCA jack).
<b>4</b> HDMI video output	This is the terminal that is used to check the test video. You can check the test video by connecting to the portable display using the HDMI cable. ■ You can view the video in 16 split screens. Only FHD video is supported.
<b>5</b> Network connection	This is the network connection terminal.
<b>6</b> Initialization	This button is used to reset the encoder settings to their factory defaults. Press and hold for about 5 seconds to reboot. ■ When the encoder is initialized, the network setting is changed in order to use DHCP. If there is no DHCP server in the network, you can use the IP installer program to reconfigure the basic network settings (IP Address, Subnet Mask, Gateway, etc.).
<b>7</b> CONSOLE	This is the console connection terminal.
<b>8</b> I/O terminal * NVR compatibility is under preparation.	RS485: Used for RS-485 communication. ALARM IN: Alarm input terminal. (1 - 16 channels) ALARM OUT: Alarm output terminal. (1 - 4 channels)
<b>9</b> Power input	This is the power input terminal.

 ■ [CONSOLE] is designed for the service repair purpose only.

Please take note of the followings before using this product.

- Do not use the product outdoor.
- Do not spill water or liquid in the connection part of the product.
- Do not impose the system to excessive shock or force.
- Do not pull out the power plug forcefully.
- Do not disassemble the product on your own.
- Do not exceed the rated input/output range.
- Use a certified power cord only.
- For the product with an input ground, use a grounded power plug.

## CHECKING THE INSTALLATION ENVIRONMENT

When mounting the SPE-1610 on a rack, comply with the following instructions.

1. Please ensure that the rack inside is not sealed.
2. Please ensure the air is circulated through the inlet/outlet as shown in the picture.
3. If you pile up the products or other rack-mount devices as shown in figure 1, secure room for ventilation or install a vent.
4. For natural air convection, place the inlet at the bottom of the rack and the outlet on top.
5. It is strongly recommended that a fan motor is installed at the inlet and the outlet for air circulation. (Please fit a filter at the inlet to screen dust or foreign substances.)
6. Please maintain the temperature inside the rack or surrounding areas between  $-10^{\circ}\text{C} \sim 40^{\circ}\text{C}$  ( $14^{\circ}\text{F} \sim 104^{\circ}\text{F}$ ) as shown in the figure.

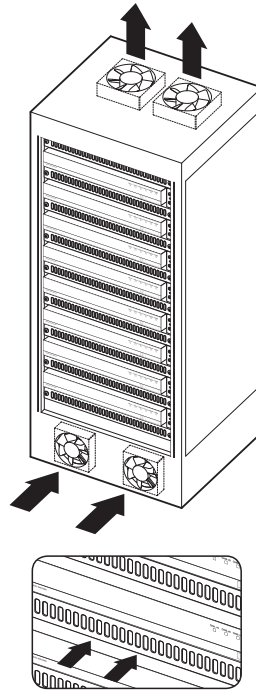

[Figure 1]

## RACK INSTALLATION

Install the Bracket-Rack as shown in the figure, and then fasten the screws on both sides (2 screws on each side).

- Remove the screws on the left and right side of the encoder before installation.
- Fix the screws not to be loosened by vibrations.

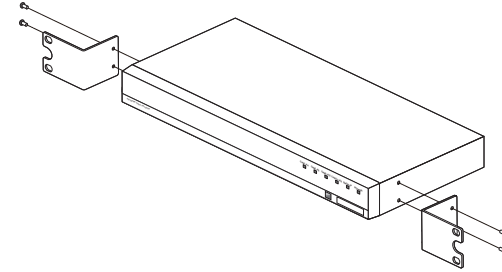

## CONNECTING WITH OTHER DEVICE

### Connecting the camera

Connect the [VIDEO IN] port of the network video encoder to the video output port of the camera.

#### SPE-410

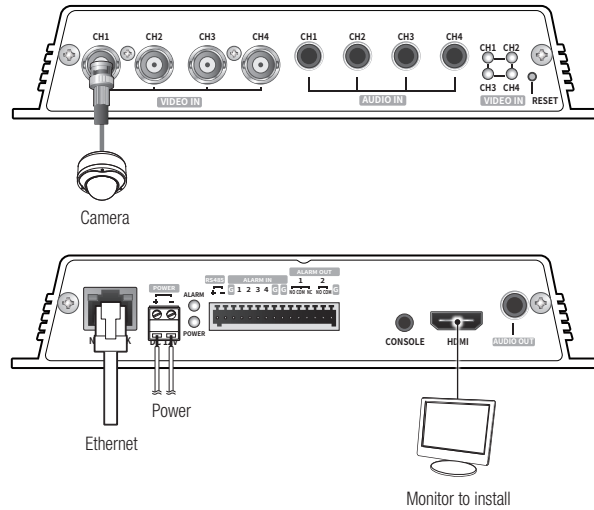

#### SPE-1610

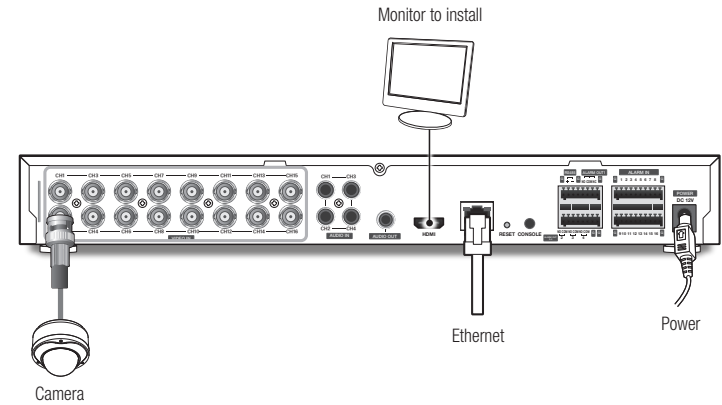

! The HDMI out terminal of the product is provided for easier installation, and is not recommended for monitoring purposes.

### Ethernet Connection

Connect the Ethernet cable to the local network or to the Internet.

## Power Supply

Use the screwdriver to connect each line (+, -) of the power cable to the corresponding power port of the encoder.

- ! ■ When connected to PoE and DC 12V power simultaneously, the device uses the external power (DC 12V). (SPE-410)
  - You can also use a router featuring PoE to supply power to the encoder.
  - Use PoE that is compliant with the IEEE802.3af protocols.
  - It is recommended to use a single source for powering the equipment among PoE and DC 12V.
- Be careful not to reverse the polarity when you connect the power cable.
- If you want to connect an external device, you must turn off the external device before proceeding.
- Connect the set and the adapter power line first, and then connect the power cable to the outlet on the wall.

## Power Cable Specification for Each Model

When the input is DC 12V :

Wire Type (AWG)	#22	#20	#18
Cable Length (Max.)	24m	38m	60m

## Network Cable Specification

Item	Contents	Remark
Connector	RJ45 (10/100/1000BASE-T)	
Ethernet	10/100/1000Base-T	To operate with 1000BASE-T, a cable of UTP-6 or higher should be used for the Giga hub.
Cable	Category 6	
Max Distance	100M	DC Resistance ≤ 0.188 Ω/m
PoE Support	IEEE 802.3af	SPE-410

## Connecting to Audio Input/Output

### SPE-410

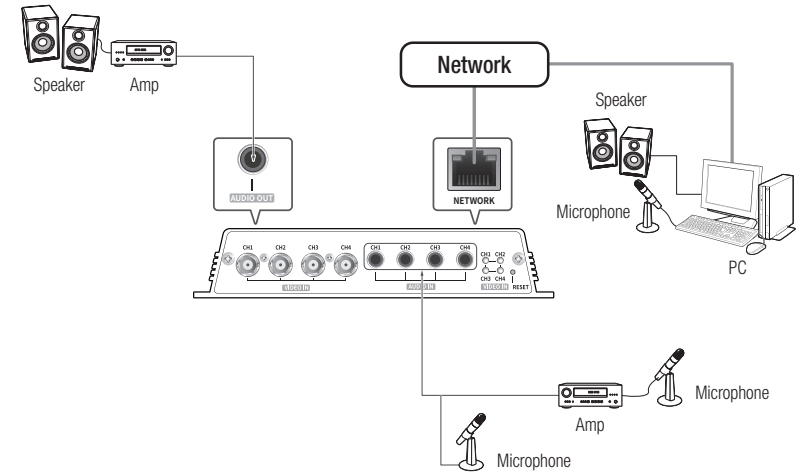

## SPE-1610

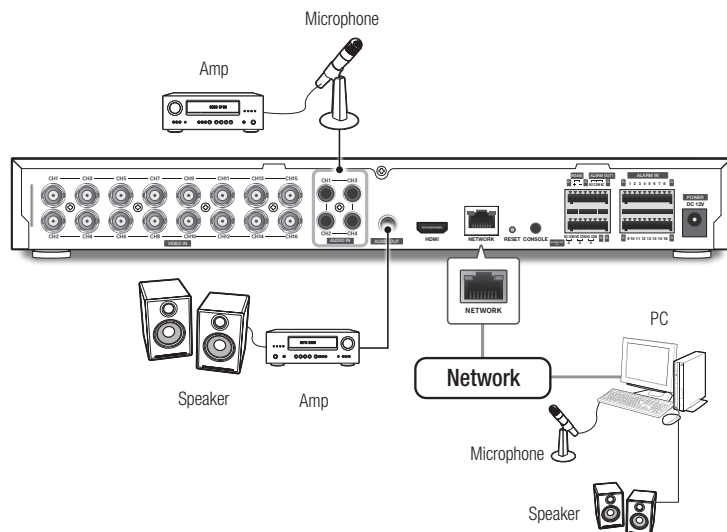

1. Connect the AUDIO IN port of the encoder with the microphone or LINE OUT port of the amplifier that the microphone is connected to.
2. Connect the AUDIO OUT port of the encoder with the speaker or LINE IN port of the amplifier that the speaker is connected to.
3. Check the specifications for audio input.

 Audio input is possible on CH1 to CH4, while audio output is only possible on CH1.

### • Audio Codec

- Audio In : G.711 PCM (Bit Rate: 64kbps / Sampling Frequency: 8kHz)
- Audio Out : G.711 PCM (Bit Rate: 64kbps / Sampling Frequency: 8kHz)

### • Full duplex Audio

- **Audio in** : Mono signal line input (Max.1.0Vpp)
- **Audio out** : Mono signal line output (Max.1.0Vpp)
- **Line out impedance** : 600Ω

## Connecting to the I/O port box

Connect the Alarm I/O signal to the corresponding port of the rear port box.

 We are preparing to provide the alarm input and output functions by connecting the encoder to the NVR. (You can check it on the homepage.)

## SPE-410

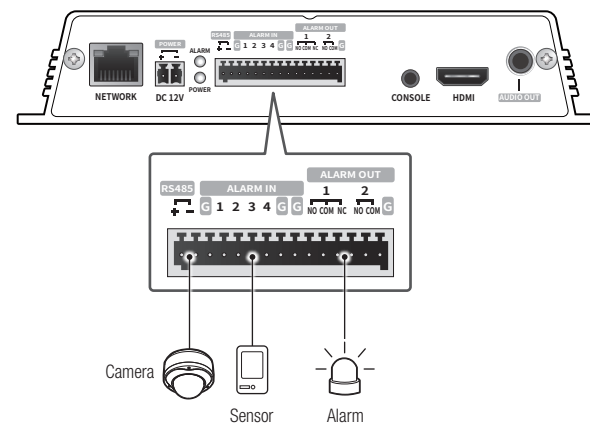

**The alarm input and output ports are configured as shown below.**

- G : Terminal for alarm ground
- ALARM OUT 1 : NO(Normal Open), COM(Common), NC(Normal Closed)
- ALARM OUT 2 : NO(Normal Open), COM(Common)
- ALARM IN 1 - 4 : Alarm input terminals

## SPE-1610

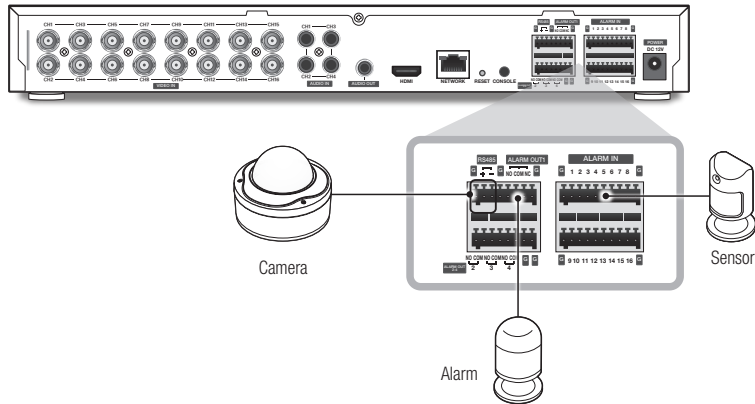

The alarm input and output ports are configured as shown below.

- G : Terminal for alarm ground
- ALARM OUT 1 : NO(Normal Open), COM(Common), NC(Normal Closed)
- ALARM OUT 2 ~ 4 : NO(Normal Open), COM(Common)
- ALARM IN 1 ~ 16 : Alarm input terminals

- ! Do not connect the Ground signal of the encoder to the power of Alarm (DC-).

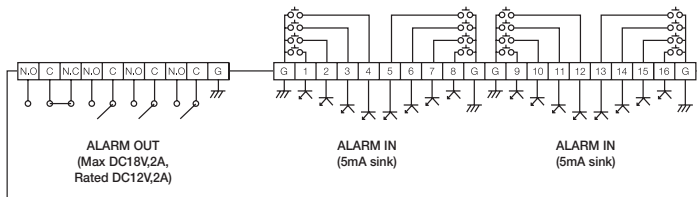

## Connecting to the Alarm Input

Connect one signal cable (out of 2) of applicable sensor to the [ALARM IN] port, and the other to the [G] port.

## Connecting the Alarm Output

Connect one signal cable (out of 2) of applicable external device to the [ALARM OUT], and the other to the [COM] port.

- ⚡ You must use the specific RS-485 alarm I/O ports for each channel.

## Connecting to the RS-485 device

Connect the external device to the [RS-485 +, -] ports. You can connect and control PTZ camera that supports RS-485 communication.

- ⚡ You can connect and control the PTZ camera which supports the RS-485 communication.
- You can control these by connecting the AUX function that supports RS-485 communication.
- Check if the RS-485 device is compatible with the product first.
- Pay attention not to change the polarity (+/-) of the RS-485 device when connecting it.
- For further information, refer to the respective Camera's documentation.

# network connection and setup

You can set up the network settings according to your network configurations.

## CONNECTING TO NETWORK THROUGH ETHERNET (10/100/1000BASET)

The connection is made using the network connection terminal on the back of the product. The figure below shows the product of SPE-1610 as an example.

1. Launch an Internet browser on the local PC.
2. Enter the IP address of the encoder in the address bar of the browser.

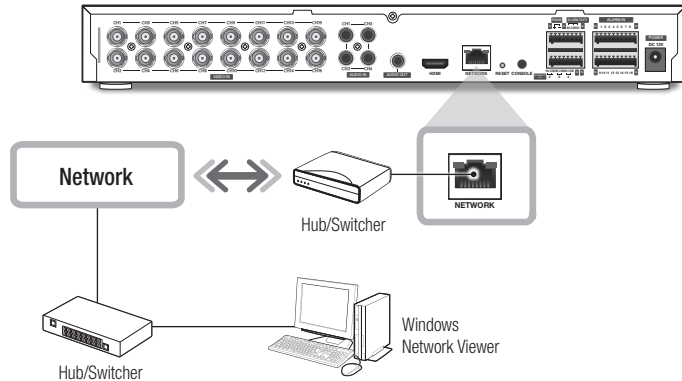

- A remote PC in an external Internet out of the LAN network may not be able to connect to the encoder installed in the intranet if the port-forwarding is not properly set or a firewall is set. In this case, to resolve the problem, contact your network administrator.
- In the IP installer, you can use the initial password, "4321" to set IP Address, Subnet Mask, Gateway, HTTP Port, VNP Port, IP type. After changing the network interface, for better security, access the web viewer and change the password.
- By factory default, the IP address will be assigned from the DHCP server automatically. If there is no DHCP server available, the IP address will be set to 192.168.1.100. To change the IP address, use the IP Installer. For further details on IP Installer use, refer to "Static IP Setup". (Page 18)

## CONNECTING THE ENCODER DIRECTLY TO A DHCP BASED DSL/CABLE MODEM

The connection is made using the network connection terminal on the back of the product. The figure below shows the product of SPE-410 as an example.

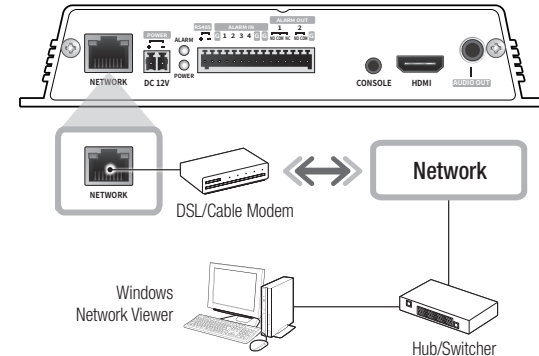

1. Connect the user PC directly with the network encoder.
2. Run the IP Installer and change the IP address of the encoder so that you can use the web browser on your desktop to connect to the Internet.
3. Use the Internet browser to connect to the web viewer.
4. Move to [Setup] page.
5. Move to [Network] – [DDNS] and configure the DDNS settings.
6. Move to [Basic] – [IP & Port], and set the IP type to [DHCP].
7. Connect the encoder, which was removed from your PC, directly to the modem.
8. Restart the encoder.

- For configuring the DDNS settings, refer to "DDNS". (page 32)
- For registering the DDNS settings, refer to "Registering with DDNS". (page 32)
- Refer to "IP & Port" for how to setup IP. (page 29)



## CONNECTING TO NETWORK THROUGH PPPoE

The connection is made using the network connection terminal on the back of the product. The figure below shows the product of SPE-410 as an example.

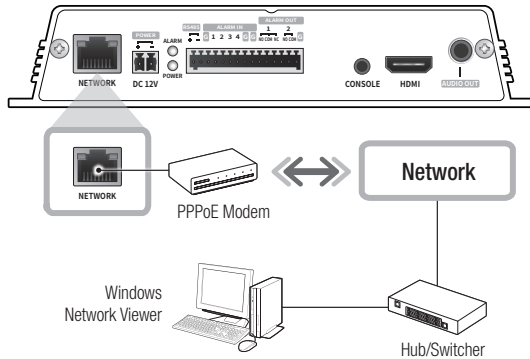

1. Connect the user PC directly with the network encoder.
2. Run the IP Installer and change the IP address of the encoder so that you can use the web browser on your desktop to connect to the Internet.
3. Use the Internet browser to connect to the web viewer.
4. Move to [Setup] page.
5. Move to [Network] – [DDNS] and configure the DDNS settings.
6. Move to [Basic] – [IP & Port] Setup Page, set the IP type to [PPPoE], and enter the network service's ID and password.
7. Connect the encoder, which was removed from your PC, directly to the modem.
8. Restart the encoder.

- For configuring the DDNS settings, refer to "DDNS". (page 32)
- For registering the DDNS settings, refer to "Registering with DDNS". (page 32)
- Refer to "IP & Port" for how to setup IP. (page 29)

## CONNECTING TO THE NETWORK USING THE ROUTER

This is for a small network environment such as homes, SOHO and ordinary shops.

The connection is made using the network connection terminal on the back of the product. The figure below shows the product of SPE-410 as an example.

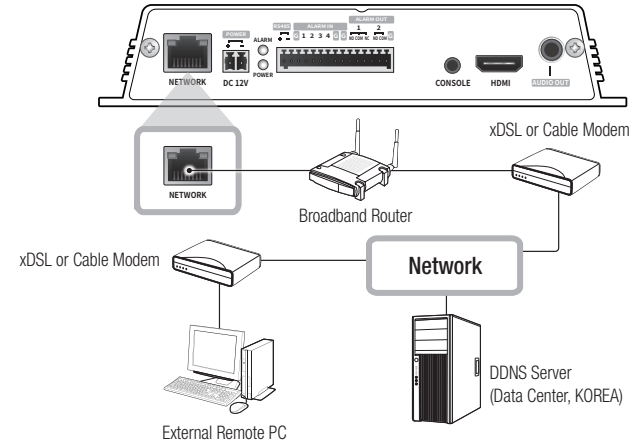

### Configuring the network settings of the local PC connected to a Broadband Router

Configuring the network settings of the local PC connected to a Broadband Router, follow the instructions below.

- Select : <Network> → <Properties> → <Local Area Connection> → <General> → <Properties> → <Internet Protocol (TCP/IP)> → <Properties> → <Obtain an IP address automatically> or <Use the following IP address>.
- Follow the instructions below if you select <Use the following IP address>:
  - ex1) If the address (LAN IP) of the Broadband Router is 192.168.1.1  
 IP address : 192.168.1.100  
 Subnet Mask : 255.255.255.0  
 Default Gateway : 192.168.1.1
  - ex2) If the address (LAN IP) of the Broadband Router is 192.168.0.1  
 IP address : 192.168.0.100  
 Subnet Mask : 255.255.255.0  
 Default Gateway : 192.168.0.1
  - ex3) If the address (LAN IP) of the Broadband Router is 192.168.xxx.1  
 IP address : 192.168.xxx.100  
 Subnet Mask : 255.255.255.0  
 Default Gateway : 192.168.xxx.1

- For the address of the Broadband Router, refer to the product's documentation.
- For more information about port forwarding of the broadband router, refer to "Port Range Forward (Port Mapping) Setup". (Page 20)

## BUTTONS USED IN IP INSTALLER

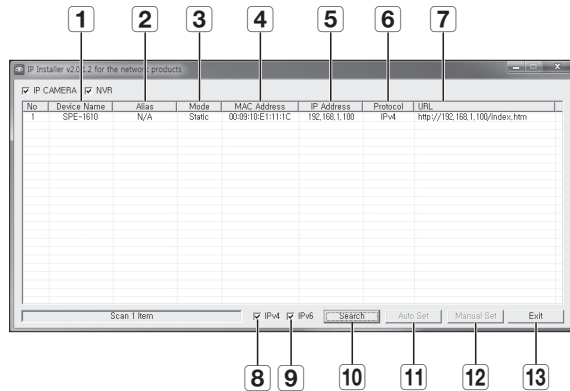

Item	Description
<b>1</b> Device Name	Model name of the connected encoder. Click the column to sort the list by model name. However, search will be stopped if clicked during the search.
<b>2</b> Alias	This function is not currently implemented.
<b>3</b> Mode	Displays either <Static>, <Dynamic> or <PPPoE> for the current network connection status.
<b>4</b> MAC(Ethernet) Address	Ethernet address for the connected encoder. Click the column to sort the list by Ethernet address. However, search will be stopped if clicked during the search.
<b>5</b> IP Address	IP address. Click the column to sort the list by IP address. However, search will be stopped if clicked during the search.
<b>6</b> Protocol	Network setting for the encoder. The factory default is "IPv4". Encoders with the IPv6 setting will be displayed "IPv6".
<b>7</b> URL	DDNS URL address enabling access from the external Internet. However, this will be replaced with the <IP Address> of the encoder if DDNS registration has failed.
<b>8</b> IPv4	Scans for encoders with the IPv4 setting.

Item	Description
<b>9</b> IPv6	Scans for encoders with the IPv6 setting. Activated in an IPv6 compliant environment only.
<b>10</b> Search	Scans for encoders that are currently connected to the network. However, this button will be grayed out if neither IPv4 nor IPv6 is checked.
<b>11</b> Auto Set	The IP Installer automatically configures the network settings.
<b>12</b> Manual Set	You should configure the network settings manually.
<b>13</b> Exit	Exits the IP Installer program.

- For the IP installer, use only the installer version provided in the installation CD or use the latest one if available. You can download the latest version from the Hanwha Techwin web site.
- If the supporting OS is Windows 8.1, it is recommended that you use the Wisenet Device Manager instead of the IP Wisenet. The Wisenet Device Manager Program can be downloaded by visiting the Hanwha Techwin website (<http://www.hanwha-security.com>) under the menu <Technical Guides> - <Online Tool>.

## STATIC IP SETUP

### Manual Network Setup

Run <IP Installer\_v2.XX.exe> to display the encoder search list.  
At the initial startup, both [Auto Set] and [Manual Set] will be grayed out.

- For encoders found with the IPv6 setting, these buttons will be grayed out as the encoders do not support this function.

- Select an encoder in the search list.  
Check the MAC address on the sticker attached to the encoder.  
Both the [Auto Set] and [Manual Set] buttons will be activated.
- Click [Manual Set].  
The Manual Setting dialog appears.  
<IP Address>, <Subnet Mask>, <Gateway>, <HTTP Port>, and <VNP Port> of the encoder are displayed in the preset values.
- In the <Address> pane, provide the necessary information.

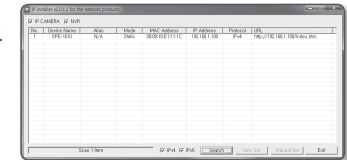

- MAC Address : The MAC address does not need to be set, as it is preset and displayed on the sticker attached to the encoder.

- IP related parameters can be set only when DHCP is not checked.

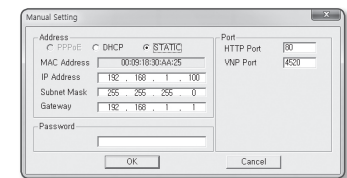

### If not using a Broadband Router

For setting <IP Address>, <Subnet Mask>, and <Gateway>, contact your network administrator.

4. In the <Port> pane, provide necessary information.

- HTTP Port : Used to access the encoder using the Internet browser, defaulted to 80.
- VNP Port : Used to control the video signal transfer, defaulted to 4520.

5. Enter the password.

Enter the password of "admin" account, which was used to access the encoder.

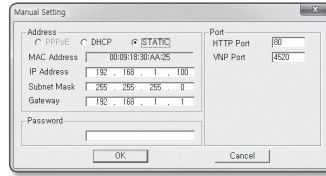

- ! For the security purposes, you are recommended to use a combination of numbers, alphabets uppercase and lowercase and special characters for your password.
- If you want to change the password, refer to "Administrator password change" of the user setup. (page 28)

6. Click [OK].

Manual network setup will be completed.

### If using a Broadband Router

- IP Address : Enter an address falling in the IP range provided by the Broadband Router.  
ex) 192.168.1.2~254, 192.168.0.2~254, 192.168.XXX.2~254
- Subnet Mask : The <Subnet Mask> of the Broadband Router will be the <Subnet Mask> of the encoder.
- Gateway : The <Local IP Address> of the Broadband Router will be the <Gateway> of the encoder.

- ✎ The settings may differ depending on the connected Broadband Router model.  
For more information, refer to the user manual of the applicable router.
- For more information about port forwarding of the broadband router, refer to "Port Range Forward (Port Mapping) Setup". (Page 20)

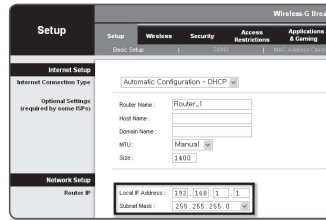

<Router example>

### If the Broadband Router has more than one encoder connected

Configure the IP related settings and the Port related settings distinctly with each other.  
ex)

	Category	Encoder #1	Encoder #2
IP related settings	IP Address	192.168.1.100	192.168.1.101
	Subnet Mask	255.255.255.0	255.255.255.0
	Gateway	192.168.1.1	192.168.1.1
Port related settings	HTTP Port	8080	8081
	VNP Port	4520	4521

- ✎ If the <HTTP Port> is set other than 80, you must provide the <Port> number in the address bar of the Internet browser before you can access the encoder.  
ex) http://IP address : HTTP Port  
http://192.168.1.100:8080

### Auto Network Setup

Run <IP Installer\_v2.XX.exe> to display the encoder search list.  
At the initial startup, both [Auto Set] and [Manual Set] will be grayed out.

- ✎ For encoders found with the IPv6 setting, these buttons will be grayed out as the encoders do not support this function.

1. Select an encoder in the search list.  
Check the MAC address on the sticker attached to the encoder. Both the [Auto Set] and [Manual Set] buttons will be activated.
2. Click [Auto Set].  
The Auto Setting dialog appears.  
The <IP Address>, <Subnet Mask>, and <Gateway> will be set automatically.
3. Enter the password.  
Enter the password of "admin" account, which was used to access the encoder.
- ! For the security purposes, you are recommended to use a combination of numbers, alphabets uppercase and lowercase and special characters for your password.
- If you want to change the password, refer to "Administrator password change" of the user setup. (page 28)
4. Click [OK].  
Auto network setup will be completed.

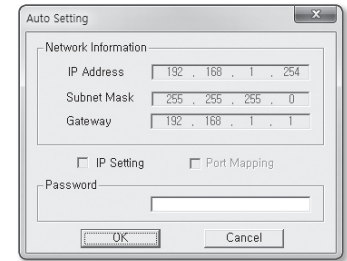
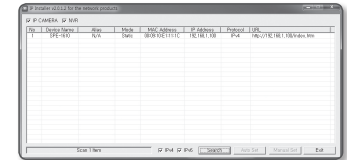

## DYNAMIC IP SETUP

### Dynamic IP Environment Setup

- Example of the Dynamic IP environment
  - If a Broadband Router, with encoders connected, is assigned an IP address by the DHCP server
  - If connecting the encoder directly to modem using the DHCP protocols
  - If IPs are assigned by the internal DHCP server via the LAN

### Checking the Dynamic IP

1. Run the IP Installer on the user's local computer.  
Encoders allocated with <Dynamic IP> address are shown in the list.
2. Select an encoder in the search list.
3. Click the [Manual Set] button and check the encoder's <Dynamic IP> address.  
If you uncheck <DHCP>, you can change IP to <Static>.

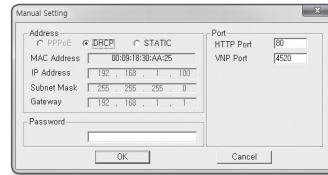
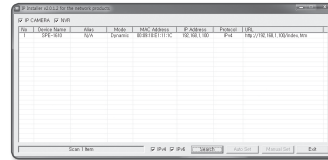

## PORT RANGE FORWARD (PORT MAPPING) SETUP

If you have installed a Broadband Router with an encoder connected, you must set the port range forwarding on the Broadband Router so that a remote PC can access the encoder in it.

### Manual Port Range Forwarding

1. From the Setup menu of the Broadband Router, select <Applications & Gaming> - <Port Range Forward>. For setting the port range forward for a third-party Broadband Router, refer to the user guide of that Broadband Router.
2. Select <TCP> and <UDP Port> for each connected encoder to the Broadband Router.  
The number of each port to be configured to the IP router should be set according to the port number designated in <Setup> - <Basic> - <IP & Port> on the encoder web viewer.

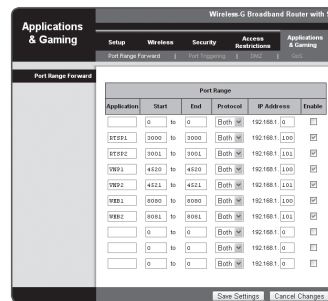

<Router example>

3. When done, click [Save Settings].  
Your settings will be saved.

- ☑ Above sample instructions are based on the CISCO's Broadband Router.
- The settings may differ depending on the connected Broadband Router model.  
For more information, refer to the user manual of the applicable router.

### Setting up Port Range Forward for several network encoders

- You can set a rule of Port Forwarding on the Broadband Router device through its configuration web page.
- A user can change each port using the encoder setting screen.

When Encoder1 and Encoder2 are connected to a router :

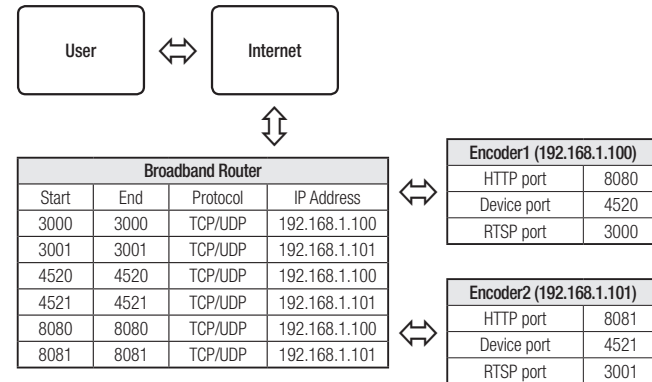

- ☑ Port forwarding can be done without additional router setup if the router supports the UPnP (Universal Plug and Play) function.  
After connecting the network encoder, select the checkbox from the menu <Quick connect> in <Wisetnet DDNS> in "Settings -> Network -> DDNS".

## CONNECTING TO THE ENCODER FROM A SHARED LOCAL PC

1. Run the IP Installer.  
It will scan for connected encoders and display them as a list.
2. Double-click an encoder to access.  
The Internet browser starts and connects to the encoder.

-  ■ Access to the encoder can also be gained by typing the encoder's IP address in the address bar of the Internet browser.

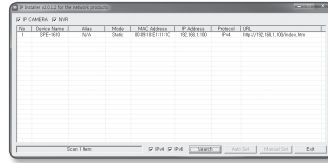

## CONNECTING TO THE ENCODER FROM A REMOTE PC VIA THE INTERNET

Since using the IP Installer on a remote computer that is not in the Broadband Router's network cluster is not allowed, users can access encoders within a Broadband Router's network by using the encoder's DDNS URL.

1. Before you can access an encoder in the Broadband Router network, you should have set the port range forward for the Broadband Router.
2. From the remote PC, launch the Internet browser and type the DDNS URL address of the encoder, or the IP address of the Broadband Router in the address bar.  
ex) <http://ddns.hanwha-security.com/ID>

-  ■ For registering the DDNS settings, refer to "Registering with DDNS". (page 32)

## CONNECTING TO THE ENCODER

### Normally, you would

1. Launch the Internet browser.
2. Type the IP address of the encoder in the address bar.
  - ex) • IP address (IPv4) : 192.168.1.100 → http://192.168.1.100
  - the Login dialog should appear.
  - IP address (IPv6) : 2001:230:abcd:ffff:0000:0000:ffff:1111 → http://[2001:230:abcd:ffff:0000:0000:ffff:1111] - the Login dialog should appear.

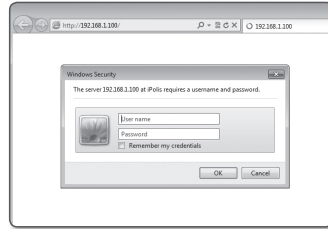

### If the HTTP port is other than 80

1. Launch the Internet browser.
2. Type the IP address and HTTP port number of the encoder in the address bar.
  - ex) IP address : 192.168.1.100:HTTP Port number(8080)
  - http://192.168.1.100:8080 - the Login dialog should appear.

### Using URL

1. Launch the Internet browser.
2. Type the DDNS URL of the encoder in the address bar.
  - ex) URL address : http://ddns.hanwha-security.com/ID
  - the Login dialog should appear.

 Network connection is disabled in the LAN only environment.

### Connecting via UPnP

1. Run the client or operating system in support of the UPnP protocol.
2. Click the encoder name for search.
  - In the Windows operating system, click the encoder name searched from the network menu.
  - The login window is displayed.

### Connecting via Bonjour

1. Run the client or operating system in support of the Bonjour protocol.
2. Click the encoder name for search.
  - In the Mac operating system, click the encoder name searched from the Bonjour tab of Safari.
  - The login window is displayed.

### To check the DDNS address

If the encoder is connected directly to the DHCP cable modem, DSL modem, or PPPoE modem, the IP address of your network will be changed each time you try to connect to the ISP (Internet Service Provider) server.

If this is the case, you will not be informed of the IP address changed by DDNS.

Once you register a dynamic IP-based device with the DDNS server, you can easily check the changed IP when you try to access the device.

To register your device to the <DDNS> server, visit <http://ddns.hanwha-security.com> and register your device first, and then set the Web Viewer's <Network> - <DDNS> to <Wisenet DDNS>, as well as providing <Product ID> that had been used for DDNS registration.

## PASSWORD SETTING

When you access the product for the first time, you must register the login password.

When the “**Password change**” window appears, enter the new password.

**Administrator password change**

New password

Confirm new password

. If the password is 8 to 9 letters long, then it should be a combination of at least three types upper/lower case alphabets, numbers and special characters.  
 . If the password is 10 to 15 letters long, then it should be a combination of at least two types upper/lower case alphabets, numbers and special characters.  
 . User name should be different from password.  
 . The following special characters are available for use: ~!@#%&^\*\_+=|{}[]?/.  
 . Don't use 4 or more characters consecutive together. (examples: 1234, abcd)  
 . Don't use 4 or more characters repeated. (examples: 111, 1111, aaaa)

- For a new password with 8 to 9 digits, you must use at least 3 of the following: uppercase/lowercase letters, numbers and special characters. For a password with 10 to 15 digits, you must use at least 2 types of those mentioned.
  - Special characters that are allowed: ~!@#%&^\*\_+=|{}[]?/
- For higher security, you are not recommended to repeat the same characters or consecutive keyboard inputs for your passwords.
- If you lost your password, you can press the **[RESET]** button to initialize the product. So, don't lose your password by using a memo pad or memorizing it.

## LOGIN

Whenever you access the encoder, the login window appears. Enter the User ID and password to access the encoder.

1. Enter “**admin**” in the <User name> input box. The administrator ID, “**admin**”, is fixed and can not be changed.
2. Enter the password in the <Password> input field.
3. Click **[OK]**.

If you have logged in successfully, you will the Live Viewer screen.

Windows Security

The server 192.168.1.100 at ipolis requires a username and password.

User name

Password

Remember my credentials







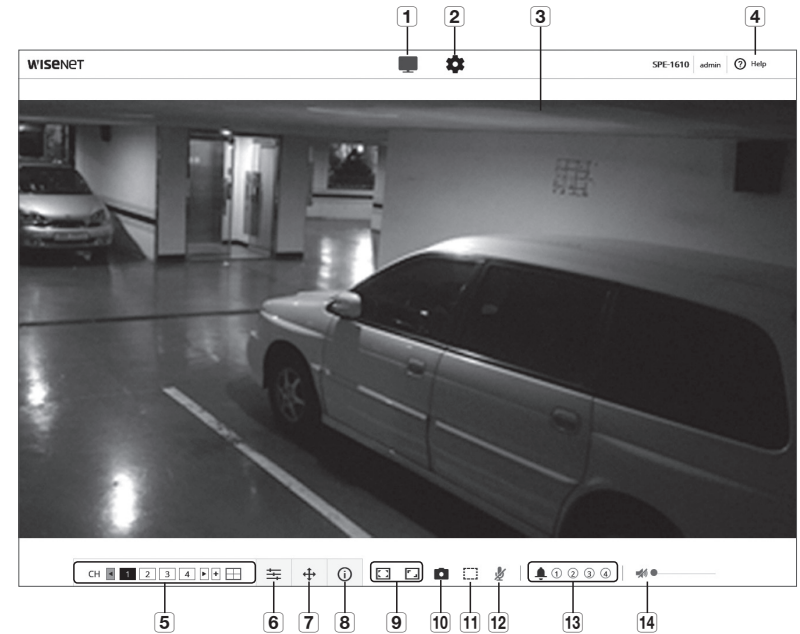





OK Cancel

- When you access the encoder web viewer, pay special attention to the security by checking whether the image data is encrypted.
- If you check the “**Remember my credentials**” option when your input is done, in future you will be logged in automatically without being prompted to enter the login information.
- You will experience the best video quality if the screen size is 100%. Reducing the ratio may cut the image on the borders.

## USING THE LIVE SCREEN







Item	Description
<b>1</b> Live	Moves to the Live screen.
<b>2</b> Setup	Move to the Setup screen.
<b>3</b> Viewer Screen	Displays the Live video on the screen. <ul style="list-style-type: none"> <li>■ You can use the mouse wheel to activate the digital zooming in Viewer screen.</li> </ul>
<b>4</b> Online help	The Online help provides detailed descriptions for each function.
<b>5</b> Channel change	Sets the camera channel to be displayed on the live screen. (Single screen / 4-split screen)

Item	Description	
<b>6</b> Profile type	<p>You can select a profile type in &lt;Video profile&gt; under the &lt;Basic&gt; setup menu.</p> <ul style="list-style-type: none"> <li>Click the icon to display the name of the current profile.</li> </ul> <p> Afterimages can be displayed on the screen under the following conditions if the video is played in the monitoring page:</p> <ul style="list-style-type: none"> <li>The resolution is changed due to a profile change.</li> <li>Incoming data is being slowed due to a network delay when the profile is changed.</li> <li>The web browser window size and location is changed.</li> </ul>	
<b>7</b> PTZ	PTZ	Controls the PAN/TILT/ZOOM motion.
	Manual focus (  /  )	Adjusts the focus of the screen to near distance or far distance.
	Zoom In (  )	Drag the bar on the right side of the UI up, or click the [  ] button to zoom in the screen. The farther the bar position is from the center, the faster the screen will be zoomed in.
	Zoom Out (  )	Drag the bar on the right side of the UI down or click the [  ] button to zoom out the screen. The farther the bar position is from the center, the faster the screen will be zoomed out.
	Move screen (  )	Moves in the direction where the cursor is located.
	OSD menu	You can control the functions of the connected camera.
<b>8</b> Profile access information	You can read the profile information.	
<b>9</b> Switch View Mode	Full Screen (  )	Double click on the video screen, and the current video will be played in the full screen of the monitor.
	Fit to screen (  )	A view mode in which the size of the camera video automatically fits to the web browser size.
	Size of the original file (  )	View mode in which the video is played in the actual resolution.
	Maintain Aspect Ratio (  )	View mode that adjusts the aspect ratio to best fit the resolution.
<b>10</b> Capture	Saves the current image as an image file.	
<b>11</b> Pixel Counter	Checks the number of pixels in the selected area on the video screen.	
<b>12</b> Microphone control	Activates the microphone.	

Item	Description
<b>13</b> Alarm output	Activate the Alarm Out port.
<b>14</b> Audio control	Activates audio and adjusts the volume.

-  Some functions may not work on a specific browser or codec.

### To change channels



- Select the desired channel number.
  - Click the [ , ,  ] icons to select a channel for SPE-1610 models.
- The viewer screen shows the corresponding channel.
- To view the 4-split screen, click the [  ] icon.
- To return to single screen, click the [  ] icon.

### To capture the snapshot



- Click [Capture (  )] on the scene to capture.
- When a captured video is saved, a notification message appears.  
The captured image is saved in the designated folder for each browser.

-  If the screen is not captured by IE browser in Windows 7 or higher, run the IE Browser with the Admin privilege.

### To fit the full screen

- Click the [Full Screen (  )] icon.
- This will fit the Viewer to the full screen.
- To leave full screen mode, click the [Full Screen (  )] button again or press the [Esc] key on the keyboard.

### To Use Audio

- Click [Audio (  )] icon to activate audio communication.
- Use [  ] bar to control the volume.

-  If there is no sound from pulling in and out the audio jack while it is in operation, click the [Audio (  )] icon to enable it again.
- To use audio, you need to set <Audio in> in "Video Profile" to <Enable> (page 26).







## To Use Microphone

Click [Mic (  )] icon to activate the microphone.

## To count the number of pixels

1. Click the [Pixel count (  )] icon to activate it.
2. Drag the mouse on the video to select an area.
3. The number of pixels in the selected area is displayed on the screen.

## To control PTZ

1. Click the [PTZ (  )] icon.
2. Move the jog dial [  ] on the Move Screen pad to move the camera direction, or zoom in or out by moving the bar on the right side of the UI up or down.
3. Select [   ] of the screen focus to adjust the focus.

## To apply the preset

- Preset : Applies the saved preset.  
Refer to “**External PTZ**” for detailed preset settings. (Page 30)
  - Move : Applies the saved preset.
  - Setup : Specifies the preset.

## To check the profile status

You can check the profile information.

1. Click the [Status (  )] icon.
2. The profile access information screen is updated whenever the screen is enabled.
  - Profile access : Show the information of the newly added profile.
    - Profile : Show the information of the newly added codec.
    - Bitrate(kbps) : Show both the actual bit rate and the set bit rate.
    - Framerate(fps) : Show both the actual frame rate and the set frame rate.
    - Concurrent users count : Show the number of concurrent users who access the profile.
  - Current users : Shows information on users accessing web viewer and displaying monitoring video.
    - Profile : Show the name of the profile accessed by the user.
    - Bitrate(kbps) : Show the current bit rate.
    - Network connection status : It shows whether the network is working fine.
    - IP address : Show the IP address of the current user.

## SETUP

You can configure the basic encoder information, PTZ, video and audio, network, event, analyze and system settings.

1. On the live screen, click the [Setup ( ⚙ )] button.
2. The Setup screen appears.

## BASIC SETUP

### Camera input

1. From the Setup menu, select the <Basic ( ■■■ )> tab.
2. Click <Camera input>.
  - Video type : CVBS/AHD/CVI/TVI
  - Resolution : SD/1M/2M/4M
  - Mode : Auto
  - Audio : On / Off

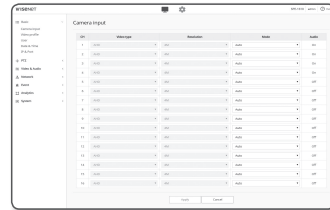

### Video profile

1. From the Setup menu, select the <Basic ( ■■■ )> tab.
2. Click <Video profile>.
3. Select the channel to set.
4. Set each item in the video profile.  
Even if the setting of the profile currently accessed is changed, the previous setting will be used for output.
5. Select each profile properties.  
For more details, refer to "To Add/Change the Video Profile". (Page 27)
6. Select a type of profile.
  - The context menu may differ depending on the selected codec type.
  - Default profile : If no profile is selected when using the Web Viewer, the default video profile is applied.
  - E-mail/FTP profile : Video profile to be transferred to the specified email or FTP site.
    - Only the MJPEG codec can be set as the E-mail/FTP profile.
7. Select whether or not to input audio in the video.  
Select the <Audio In> check box and you can input audio in the video.
8. When done, click [Apply].

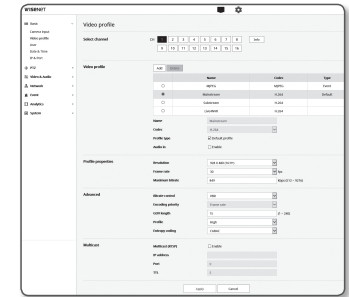

## To Add/Change the Video Profile

The profile setup can be added or modified to accommodate various profiles depending on the recording conditions.

1. In <Video profile>, click the <Add> button.
  2. Provide the name and select a codec.
  3. Specify the conditions under which the codec will be applied.
  4. Specify the details of the selected codec including resolution and frame rate.
    - Resolution : Set the video size of the H.264 and MJPEG files.
    - Framerate : Set the max number of video frames per sec.
    - Maximum bitrate : Set the max bit rate of video when the bit rate control is set to VBR.
      - ! ■ As the bit rate can be adjusted limitedly according to the resolution, frame rate and screen complexity, the actual bit rate can be greater than the maximum bit rate. So you must consider the use conditions when setting the value.
    - Target bitrate : Set the target bit rate when the bit rate control is set to CBR.
    - Bitrate control : You can select one from constant bit rate and variable bit rate for compression. Fixed bitrate means that the network transmission bitrate is fixed while varying the video quality or frame rate, variable bitrate means that a higher priority is placed on the video quality while varying the bitrate.
      - ! ■ After setting the fixed bit rate for bit control, if you select the video quality priority mode, depending on the complexity of the screen, the actual transmitted frame rate may differ from the frame rate setup in order to guarantee the optimal video quality for the given bit rate.
- Encoding priority : You can set the priority of video transmission to frame rate or compression.
  - GOV length : It specifies the distance (in terms of number of frames) between two consecutive I-Frames in a video sequence when H.264 codec was selected. (One I-Frame + 0~Several P-Frames)
  - Profile : You can select the profile of H.264 codec.
  - Entropy coding : This is variable length coding using syntax statistics. It uses lossless compression techniques. You can set the entropy coding method. The compression rate of CABAC is better than CAVLC.

- Multicast(RTSP) : Specify the use of the RTSP protocol.
  - IP address : Enter an IPv4 address with which you can connect to the IPv4 network.
  - Port : Specify the video communication port.
  - TTL : You can set the TTL for the RTP packet.



- If you set the Multicast address to 224.0.0.0~224.0.0.255, multicast may not work properly in all environments. In that case, we recommend you change the multicast address.

### What is GOV length?

GOV(Group of Video object planes) is a set of video frames for H.264 compression, indicating a collection of frames from the initial I-Frame to the next I-Frame. GOV consists of 2 kinds of frames: I-Frame and P-Frame. I-Frame is the basis frame of compression, and contains data for a completed single image. P-Frame contains only the data that has changed from the preceding I-Frame.

For H.264 codec, you can determine the GOV length.

If you set a recording profile with H.264 codec, the GOV length will be framerate/2.

## User

1. From the Setup menu, select the <Basic (  )> tab.

2. Click <User>.

3. Provide the necessary user information.

- Administrator password change : Change the password for the administrator.



- For the security purposes, you are recommended to use a combination of numbers, alphabets uppercase and lowercase and special characters for your password.
- It is recommended to change your password once every three months.
- The password length and limits are shown as follows.
  - A combination of at least three types of upper case, lower case, numeric, and special characters: 8 to 9 characters.
  - A combination of at least two types of upper case, lower case, numeric, and special characters: 10 to 15 characters.
  - Should be different from the ID.
  - Don't use 4 or more characters consecutive together. (examples : 1234, abcd)
  - Don't use 4 or more characters repeated. (examples : !!!!, 1111, aaaa)
  - Special characters that are allowed. : ~!@#%&^\*\_+|=![]].?/
  - After the factory setting, the admin and user passwords are initialized. You need to reset the password.
  - When you access the encoder web page for the first time or access it after the initialization, you will be moved to the admin password setting menu.
  - In this menu, you need to login again with the new password before using the encoder web page menus.
  - If the existing password is not matched, when you change the admin password, you cannot change the password.
  - After changing your password, if there is an encoder connected to a CMS or NVR client, then you need to re-register it with the newly changed password. If the encoder is still connected with the same password, then the account may be locked because a client uses the previous password.
- If you try to login with the registered account, 5 or more consecutive password authentication has failed, and then the account may be locked for thirty seconds.
- When the password is changed while multiple connections are active from a PC, the browser may malfunction. In that case, reconnect to the server.

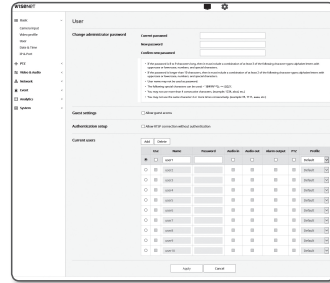

- Guest setup : If you select <Enable guest access>, the guest account can access the Web viewer screen but can only view the live Viewer screen.
  - The ID/password for the guest account is <guest/guest>, which cannot be changed.
- Authentication setup : If you select <Enable RTSP connection without authentication>, you can access RTSP without logging in and view the video.
- Current users : If you select <Use>, you can set or change the user permissions.
  - The administrator can set the audio input, audio output, alarm output, PTZ control permissions.
  - Audio input/Audio output/Alarm output : You can enable/disable Audio input/Audio output/Alarm output in the live mode on the current user account.
  - PTZ Control : Select the <PTZ>.
  - Profile : If you select <Default>, you can only see the default profile video; if selecting <All>, you can see the full profile videos.



- ONVIF functions available to a registered user allowed to use ONVIF functions are limited to those of granted with permission.

4. When done, click [Apply].

## Date & Time

- From the Setup menu, select the **<Basic (Basic icon)>** tab.
- Click **<Date & Time>**.
- Specify the time and date that will be applied to the encoder.
  - Current system time : Displays the current time settings of your system.
  - Timezone : Specify the local time zone based on the GMT.
  - Daylight saving time : If checked, the time will be set one hour before the local time zone for the specified time period.  
This option will be displayed only in areas where DST is applied.
  - System time setup : Specify the time and date that will be applied to your system.
    - Manual : Sets the current time of the encoder manually.  
When you select the **<Synchronize with PC viewer>** check box, the time of the webviewer is set to the time displayed on the PC that runs the webviewer.
    - Synchronize with NTP server : Sync with the time of the specified server address.
- When done, click **[Apply]**.

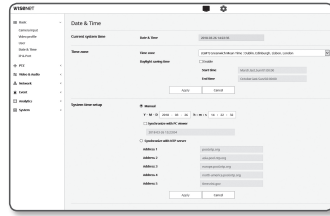

- If you select the **<Synchronize with PC viewer>**, the standard timezone should be set the same as the current timezone in PC.

## IP & Port

- From the Setup menu, select the **<Basic (Basic icon)>** tab.
- Click **<IP & Port>**.
- Click **<IP address>**.
- Set the **<IPv4 setup>**.
  - IP type : Select an IP connection type.
    - Manual : Sets the IP address, subnet mask, gateway, DNS1, DNS2 and host name.
    - DHCP : Sets DNS1, DNS2, and host name.
    - PPPoE : Sets DNS1, DNS2, host name, ID and password.
  - If you set it to **<Manual>**, you should specify the IP, Subnet mask, Gateway, DNS 1 & 2 manually.
  - MAC address : Shows the MAC address.
  - IP address : Displays the current IP address.
  - Subnet mask : Displays the **<Subnet mask>** for the set IP.
  - Gateway : Displays the **<Gateway>** for the set IP.
  - DNS1/DNS2 : Displays the DNS(Domain Name Service) server address.
  - Host name : Displays the host name.

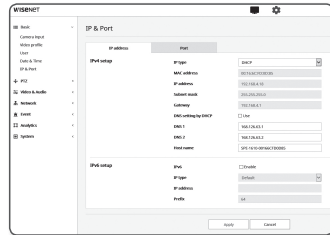

- Set the **<IPv6 setup>**.
  - Set to **<Use>** to use IPv6 address.
    - Default : Use the default IPv6 address.
    - DHCP : Display and use the IPv6 address obtained from the DHCP server.
    - Manual : Enter IP address and gateway manually and use it.
- The IP addressing system will be defaulted to DHCP. If no DHCP server is found, the previous settings will be restored automatically.
  - Once completed with editing, click **[Apply]** to apply changes and the browser exits. After a while, connect again with the changed IP.
- Click **<Port>**.
- Type in each item in the Port menu as necessary.
  - Neither the port range between 0 and 1023 nor port 3702 is available.
    - HTTP : HTTP port used to access the encoder via the web browser. The default is 80(TCP).
      - Setting the HTTP port for Safari and Google Chrome browsers to 65535 is not allowed by security policy.
    - HTTPS : In this version, the security of the web communication protocol HTTP is strengthened. It can be used when you set HTTPS mode in SSL. The initial value is set to 443(TCP).
      - The available setting range is 1024~65535. (For security reasons, in your Safari or Google Chrome browser, you may not use 65535 as your HTTPS port.)
    - RTSP : Used to transfer videos in the RTSP mode; the default is 554.
    - Timeout : When connecting to RTSP, this function resets the connection if there's no response for a certain time.
  - If changed the HTTP port, the browser exits.
    - Afterwards, address should contain the newly assigned HTTP port trailing the IP.  
ex) IP address: 192.168.1.100, HTTP port : Assigned 8080 → http://192.168.1.100:8080  
(If HTTP port is set to 80, no need to specify the port number)
    - Using RTSP and HTTPS is recommended in order to prevent the image information from being restored.
- When done, click **[Apply]**.

## PTZ SETUP

### External PTZ

Sets the connection value of the external PTZ camera so that the PTZ can be controlled through the camera connected to the RS-485 terminal of the encoder.

- From the Setup menu, select the <PTZ ( + )> tab.
- Click <External PTZ>.
- Select the channel to set.
- Please set the connection port.
  - RS-485 : Select this if you want to control the camera and remote AUX via the RS-485 terminal.
  - Coaxial : Set for camera control. PTZ and OSD can be controlled.
- Please set the serial port. If you select <RS-485> as the connection port, you can set the RS-485 communication mode of the connected PTZ camera.
  - Protocol : Selects the same protocol as the camera, from among Samsung-T / Pelco-D / Pelco-P.
  - Camera ID : Displays the fixed camera ID.
  - Baudrate : Transfer rate for RS-485 communications.
  - Data bit : Specify the data bit.
  - Parity bit : Specify the parity bit.
  - Stop bit : Specify the stop bit.
- When done, click [Apply].



For this operation, the encoder and the PTZ camera should be connected normally. In addition, the serial port must be set to operate the PTZ camera.

Check the functions supported by the camera when it is connected. Some functions may be disabled depending on the camera or protocol specification. Refer to the following table for more details.

### Functions Supported for Each Protocol

Protocol	P control	P movement speed	T control	T movement speed	Zoom control	Zoom movement speed	Focus control	Focus control speed	Preset save	Preset movement	Remarks
SAMSUNG-T	0	0	0	0	0	0	0	X	0	0	
PELCO-D	0	0	0	0	0	0	0	X	0	0	
PELCO-P	0	0	0	0	0	0	0	X	0	0	

- Click the cursor [ + ] on the screen moving pad to control movement of the screen.
  - Move screen: Scroll the cursor in the direction desired.
  - Control screen movement rate: The farther away the cursor is from the center, the faster it moves on the screen.
- Control zoom movement.
  - Zoom In: Move up the bar in the right of the UI, or press the [ + ] button. The farther the bar is from the center, the faster the screen expands.
  - Zoom Out: Move down the bar in the right of the UI, or press the [ - ] button. The farther the bar is from the center, the faster the screen reduces in size.
- Adjust the focus.
  - Manual focus ( / ▲ ) : Adjusts the focus of the screen for short distance or long distance.

Pan/tilt/zoom control is only possible when the encoder is connected to the PTZ camera and <Serial port setup> is set normally.

### To add a preset

- Select the preset number to add.
- Set the name for the preset.
- Press the [Add] button.

### To delete a preset

- Select the preset number to delete.
- Press the [Remove] button.

### To move a preset

- Select a preset number that you want to move.
- Press the [Go] button.

## VIDEO & AUDIO SETUP

### Video setup

1. From the Setup menu, select the <Video & Audio (📺)> tab.
2. Click <Video setup>.
3. Select the channel to set.
4. Specify the privacy zone.
5. When done, click [Apply].

### To set the privacy zone

You can specify a certain area of the camera video to be protected for your privacy.

1. Select the <Enable Privacy area> checkbox.
2. Click [OK].
3. Click and drag over the video to select an area.
4. Enter the name and select the color, and then click [OK].
5. If you want to delete a name in the list, select it and click [Delete].

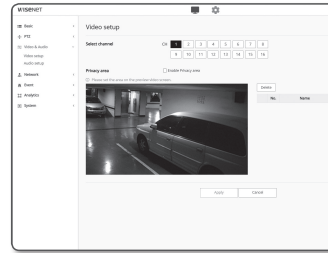

### Audio setup

You can set the input/output value of the audio connected to the encoder.

1. From the Setup menu, select the <Video & Audio (📺)> tab.
2. Click <Audio setup>.
3. Select the channel to set.
4. Set the audio input value.

- Source : Input audio.
  - Line : Connect the cable to the audio device.
- Codec : Audio codec to use.
  - G.711 : A audio codec standard, it uses 64 Kbps PCM (Pulse Code Modulation) encoding. ITU standard audio codec that is adequate for digital voice transfer in PSTN network or through a PBX.
  - Sampling rate : Refers to the number of times of sampling when digitalizing an analog soundtrack. The higher this value is, the better the sound quality is.
  - Bitrate : Set the compression ratio based on the bit rate.
  - Gain : Specify the audio input amplification.

- ! ■ Sound quality deterioration or howling may occur if the loudness of the sound source or gain value were set excessively.
5. Set the audio output level.
    - Enable : Sets whether to use audio output.
    - Gain : Specify the audio output amplification.
  6. When done, click [Apply].

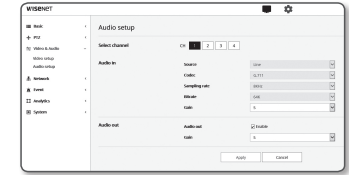

## NETWORK SETUP

### DDNS

DDNS is an abbreviation of Dynamic Domain Name Service that converts the IP address of an encoder into a general Host Name so that the user can easily remember it.

! You can use the DDNS service only if the internet is connected.

1. From the Setup menu, select the <Network (  )> tab.
2. Click <DDNS>.
3. Select the <DDNS> connection type.
4. Type in the DDNS items according to the selected type.
  - Wisenet DDNS : Select this if you use the DDNS server provided by Hanwha Techwin.
    - Product ID : Enter the product ID that is registered with the Wisenet DDNS service.
    - Quick connect : It sets port forwarding automatically when used with a UPnP (Universal Plug and Play) supporting router.



 If you want to use the DDNS service without using a hub that supports the UPnP function, click Quick connect, then go to the hub menu and activate port forwarding for your hub. For more on how to set port forwarding for your hub, refer to "**Port Range Forward (Port Mapping) Setup**". (page 20)

- Public DDNS : Select one of provided public DDNS servers when you use a public DDNS server.
  - Server : Select desired public DDNS service server.
  - Host name : Enter the name of the host that is registered with the DDNS server.
  - User name : Enter the user name for the DDNS service.
  - Password : Enter the password for the DDNS service.

5. When done, click [Apply].

! If selected <Quick connect>, be sure to select Wisenet DDNS service.

### Registering with DDNS

To register your product with the Wisenet DDNS

1. Visit the Wisenet DDNS web site (<http://ddns.hanwha-security.com>) and sign in with a registered account.



2. From the top menu bar, select <MY DDNS>.



3. Click the [Register Product] tab.

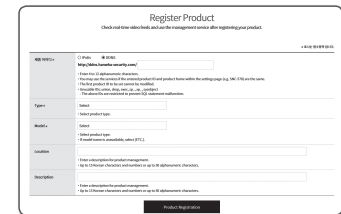

4. Enter the product ID.

5. Select a <Type> and specify the <Model>.

6. Specify the product location with a description if necessary.

7. Click [Product Registration].

The product will be added to the product list that you can check.

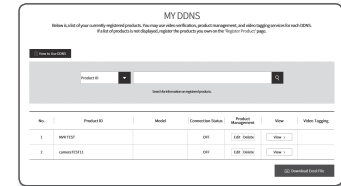



**To connect to the Wisenet DDNS in encoder setup**

1. From the DDNS setup page, set <DDNS> to <Wisenet DDNS>.
2. Provide the <Product ID> that you registered product ID with the DDNS site.
3. Click [Apply].  
When the connection is successfully made, you will see the message of <(Success)> on the screen.

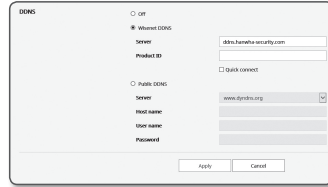

**Configuring public DDNS in encoder Settings**

1. Open the DDNS settings page and select <Public DDNS> for <DDNS>.
2. Enter the corresponding site's host name, user name and password.
3. Click [Apply] button.  
If the connection properly establishes, <(Success)> appears.
4. When done, click [Apply].

- To use DDNS service properly, both DDNS setup and the router's port forwarding setup are required. For port forwarding setup, refer to "Port Range Forward (Port Mapping) Setup", (page 20)

**IP filtering**

You can create a list of IPs that you want to grant or deny access to them.

1. From the Setup menu, select the <Network ( )> tab.
2. Click <IP filtering>.
3. Select <Filtering type>.
  - Deny registered IP : If selecting this, access from those IPs that are added to the filtering will be restricted.
  - Allow registered IP : If selecting this, access from only those IPs that are added to the filtering will be accepted.
4. Click the [Add] button.  
The IP list will be created.
5. Provide the IP that you want to grant or deny access from.  
When you enter an IP address and a Prefix, the list of IP addresses available will appear in the right-side filter range column.



- If selected <Allow registered IP> for IP Filtering and <IPv6 setup> of <IP & Port> is set to <Use>, both IPv4 and IPv6 addresses of the computer currently configuring should be assigned.
  - The IP address of the computer used for the current setup cannot be added to <Deny registered IP>, it should be added to <Allow registered IP>.
  - Only the IP addresses that are set to <Use> will be displayed in the filter column.
6. Select an IP to delete from the list.  
Click the [Delete] button.
  7. When done, click [Apply].

**HTTPS**

You can select a secure connection system or install the public certificate for this purpose.

1. From the Setup menu, select the <Network ( )> tab.
2. Click <HTTPS>.
3. Select a secure connection system.
  - To access the encoder using HTTPS mode, you have to type the IP address for the encoder in the form of "https://<encoder\_IP>".  
If you failed to configure the Web viewer settings in HTTPS mode with Internet Explorer, edit the Internet options as follows: <Menu → Tools → Internet Options → Advanced → Security → Uncheck TLS 1.0, and check TLS 1.1, TLS 1.2>
4. Search for the public certificate that you want to install on the encoder.  
To install the certificate on the encoder, you need to provide a certificate name (it can be arbitrarily assigned by the user), certificate file issued from the certification authority and a key file.
  - The <HTTPS (Secure connection mode using the public certificate)> item will be active only if there exists a public certificate installed.
5. When done, click [Apply].

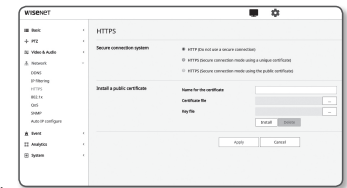

**Installing the certificate**

1. Enter the certificate name.
2. Click the [Browse ( )] button, select the public certificate file and key file to be installed, and then click the [Install] button.

**Deleting the certificate**

1. Click [Delete] button.
2. To delete a public certificate, you should access the network video decoder in the mode of <HTTP (Do not use secure connection)> or <HTTPS (Secure connection mode using a unique certificate)>.

## 802.1x

When connecting network, you can choose whether using 802.1x protocol, and then install the certification.

1. From the Setup menu, select the **<Network (  )>** tab.
2. Click **<802.1x>**.
3. Set the **<IEEE 802.1x setting>**.

- IEEE 802.1x : Specify the use of the 802.1x protocol.
- EAP type : Select EAP-TLS or LEAP.
- EAPOL version : Select version 1 or 2.
- ID : Enter the client certificate ID in EAP-TLS and the user ID in LEAP.
- Password : Enter the client private key password in EAP-TLS and the user password in LEAP. You do not have to enter the password in EAP-TLS if it uses a key file that is not encrypted.

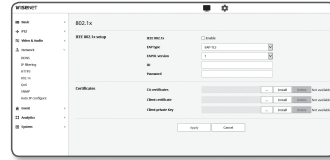

-  ■ If the connected network device does not support the 802.1x protocol, the protocol will not operate properly even if you set it.
- LEAP is an authentication method with poor security. Use it only in an environment where EAP-TLS is not available.

4. Install/remove the certificate.

The certificate is needed only for EAP-TLS.

- CA certificates : Select a public certificate that contains the public key.
- Client certificate : Select a public certificate that contains the client certificate key.
- Client private Key : Select a public certificate that contains the client private key.

5. When done, click **[Apply]**.

### To install/remove 802.1x related certificates

1. Press the **[Browse (  )]** button for each item and select a certificate to install.
2. If no certificate is installed, you will see "Not Available" appearing next to the selected item.
3. Press the **[Install]** button to start installation with a message of "Installed" next to the item.
4. Press the **[Delete]** button to remove the certificate.

## QoS

You can specify the priority to secure a stable transfer rate for a specific IP.

1. From the Setup menu, select the **<Network (  )>** tab.
2. Click **<QoS>**.
3. Click the **[Add]** button.  
The IP list will be created.
4. Enter an IP address to which you will apply QoS.



-  ■ The default prefix for IPv4 is 32;  
For DSCP, the default is set to 63.
- Only the IP addresses that are set to **<Use>** can be prioritized.

5. Select an IP to delete from the list.  
Click the **[Delete]** button.
6. When done, click **[Apply]**.

## SNMP

With the SNMP protocols, the system or network admin can monitor the network devices on a remote site, and configure the environment settings.

1. From the Setup menu, select the <Network (  )> tab.
2. Click <SNMP>.
3. Specify the <SNMP>.

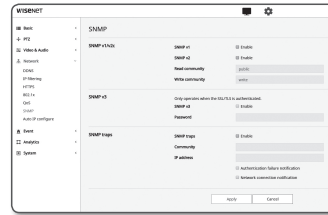

- Enable SNMP v1 : SNMP version 1 will be active.
- Enable SNMP v2c : SNMP version 2 will be active.
  - Read community : Provide the name of the read community where you can access to the SNMP information.  
The default name is <public>.
  - Write community : Provide the name of the write community where you can access to the SNMP information. The default name is <write>.
- Enable SNMP v3 : SNMP version 3 will be active.
  - Password : Specify the default password for SNMP version 3.
    - The default password can be exposed to a hacking thread so it is recommended to change the password after installing the product.  
Note that the security and other related issues caused by the unchanged password shall be responsible for the user.
    - Password should be longer than 8 characters, no more than 16 characters.
- Enable SNMP Trap : SNMP trap is used to send important events and conditions to the Admin.
  - Community : Enter the trap community name to receive messages.
  - IP address : Enter the IP address to which messages will be sent.
  - Authentication failure notification : It specifies whether an event shall be generated when the community information is invalid.
  - Network connection notification : It specifies whether an event shall be generated when the network disconnection is restored.

4. When done, click [Apply].

- ! ■ SNMP v3 is only able to be set when the secure connection mode is HTTPS.  
Refer to "HTTPS". (page 33)
- If you don't use SNMP v3, there may be a security issue.

## Auto IP configure

You can set the IP available for access and encoder searching automatically.

1. From the Setup menu, select the <Network (  )> tab.
2. Click <Auto IP configure>.
3. Set the <Link-Local IPv4 address>.

An additional IP address may be assigned to assess the encoder from the Link-Local network.

- Auto configure : It specifies Able or Disable for the Link-Local IPv4 address.
- IP address : Display the assigned IP address.
- Subnet mask : Display the subnet mask of the assigned IP.

4. Set the <UPnP discovery>.

Encoders can be automatically searched in the client and operating system in support of the UPnP protocol.

- UPnP discovery : It specifies Able or Disable for UPnP Discovery.
- Friendly name : Display the encoder name.  
Friendly name is displayed in the format of WISENET-<Model Name>-<MAC Address>.



- In the Windows operating system which basically supports UPnP, the encoders connected to the network are displayed.

5. Set the <Bonjour>.

Encoders can be automatically searched in the client and operating system in support of the Bonjour protocol.

- Bonjour : It specifies Able or Disable for Bonjour.
- Friendly name : Display the encoder name.  
Friendly name is displayed in the format of WISENET-<Model Name>-<MAC Address>.



- In the Mac operating system, which support Bonjour by default, the connected encoders are automatically displayed in the Bonjour bookmark of the Safari web browser.  
If the Bonjour bookmark is not displayed, check Bookmarks Setup in the "Preference" menu.

6. When done, click [Apply].

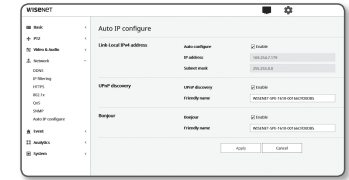

## EVENT SETUP

### Event setup

You can easily set the event detection items, and move to the detailed setting.

1. From the Setup menu, select the <Event (🔍)> tab.
2. Click <Event setup>.
3. Activate desired items on the Event list.
4. When done, click [Apply].

- To configure detailed event settings, click a desired type. You will be redirected to the detailed settings.

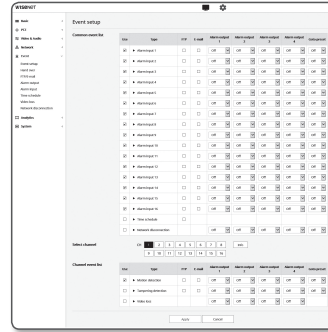

### Hand over

Event detection can be used in conjunction with an additional camera with a PTZ preset function. When an event is detected, the interworking PTZ camera moves to the preset position and can perform monitoring.

1. From the Setup menu, select the <Event (🔍)> tab.

2. Click <Hand over>.

- Receiver camera : Register the camera that is to be interworking with event detection. Click [Add] at the top of the menu to enter the IP, port, ID, password of the camera to be interworked, and the preset number to move to when detecting an event.

- Hand over can be used for motion detection/tamper detection/sound classification/I/O event detection.
- Only operates normally if the preset set in the receiver camera is specified.
- Hand over supports only one preset per area.

3. When done, click [Apply].



## FTP / E-mail

You can configure the FTP/E-mail server settings so that you can transfer the images taken with camera to your PC if an event occurs.

1. From the Setup menu, select the <Event (  )> tab.
2. Click <FTP / E-mail>.
3. Select <FTP configuration> or <E-mail configuration> and enter / select a desired value.

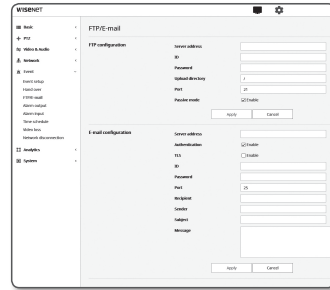

- FTP configuration
    - Server address : Enter the IP address of the FTP server that you transfer the alarm or event images to.
    - ID : Enter the user ID with which you will log in to the FTP server.
    - Password : Enter the user account password for logging into the FTP server.
    - Upload directory : Specify the FTP path where you will transfer the alarm or event images.
    - Port : The default port of the FTP server is 21; however, you can use a different port number according to the FTP server settings.
    - Passive mode : Select <On> if you need to connect in passive mode due to the firewall or the FTP server settings.
  - E-mail configuration
    - Server address : Enter the SMTP address of the email server that you transfer the alarm or event images to.
    - Authentication : Select whether to use authorization.
    - TLS : Specify the use of TLS.
    - ID : Enter the user ID for logging into the email server.
    - Password : Enter the user account password for logging into the email server.
    - Port : The default port of the email server is 25; however, you can use a different port number according to the email server settings.
    - Recipient : Enter the address of the email recipient.
    - Sender : Enter the address of the email sender. If the sender address is incorrect, the email from the sender may be classified as SPAM by the email server and thus may not be sent.
    - Subject : Enter a subject for your email.
    - Body : Provide the text for the message. Attach the alarm or event images to the email that you are preparing.
4. When done, click [Apply].

## Alarm output

1. From the Setup menu, select the <Event (  )> tab.
  2. Click <Alarm output>.
  3. Set the alarm output of the encoder.
    - If you change the alarm output type, the alarm out button on the monitoring page and alarm output type displayed on Event Setup page will be changed accordingly.
  - Type
    - N.O. (Normal Open) : Considers "Open circuit" status of the sensor or alarm input device as normal, and triggers alarm event if becomes "Closed circuit" status.
    - N.C. (Normal Close) : Considers "Closed circuit" status of the sensor or alarm input device as normal, and triggers alarm event if becomes "Open circuit" status.
  - Mode : Sets the alarm output method.
    - There is difference between operations when clicked alarm output button while disabled.
    - Pulse : It is activated during the time period specified by the duration (switching interval) and then becomes inactive automatically.
    - Active/Inactive : It maintains as activated until the user clicks the button again to make it inactive.
  - Duration : Set the alarm duration that maintains activated if the mode is set to pulse, from 1 to 15 seconds.
4. When done, click [Apply].

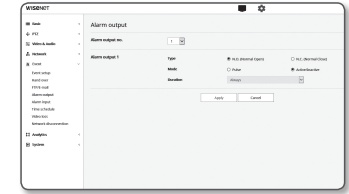

## Alarm input

You can set the alarm input type, activation time, and operation mode.

1. From the Setup menu, select the <Event (🏠)> tab.

2. Click <Alarm input>.

3. Set whether or not to <Enable>.

4. Select the type.

- N.O. (Normal Open) : It is normally open, but if it is closed, an alarm will be triggered.
- N.C. (Normal Close) : It is normally closed, but if it is open, an alarm will be triggered.

5. Specify the <Event activation time>.

- Always : Always check if an alarm occurs. It activates in operated mode when the alarm occurs.
  - If set to <Always>, the activation time cannot be changed.
- Only scheduled time : Check if an alarm occurs at a specified day of the week for a specified time period. It activates in operated mode when the alarm occurs.
  - [ 1 min 30 min 1 h ] : Sets the time display format on the vertical axis.
  - [Reset] : Reset all settings.

6. Specify an operation that will perform if an alarm occurs.

- FTP : Specify the use of FTP transfer in the alarm input setup.
  - Refer to "FTP / E-mail" for more details. (page 37)
- E-mail : Specify the use of email transfer in the alarm input setup.
  - Refer to "FTP / E-mail" for more details. (page 37)
- Alarm output : Select whether to set the alarm output if an alarm is incoming, and specify the alarm output time.
- Goto preset : Moves to the specified preset location when setting the alarm input.
  - Preset Move is possible only when the encoder and PTZ camera are connected.
    - Only the preset of the same channel as the alarm input number can be set. (e.g., Alarm 2 → Channel 2 → Preset of Channel 2)

7. When done, click [Apply].

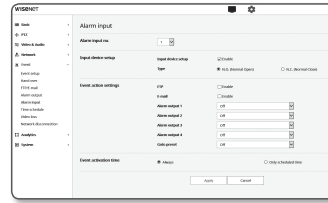

## Time schedule

You can configure settings to transmit images at regular intervals at a scheduled operation time regardless of the occurrence of an event.

1. From the Setup menu, select the <Event (🏠)> tab.

2. Click <Time schedule>.

3. Set whether or not to <Enable>.

4. Specify the <Transfer interval>.

5. Specify the <Event activation time>.

- Always : Always activates in operated mode at the set interval.
- Only scheduled time : Periodically activates in operated mode at a specified time and date.



- The transfer interval setting value must be smaller than the preset activation interval to succeed in image transmission.

6. Specify the activation conditions.

- FTP : Specify the use of the FTP transfer if an event occurs.
  - Refer to "FTP / E-mail" for more details. (page 37)

7. When done, click [Apply].

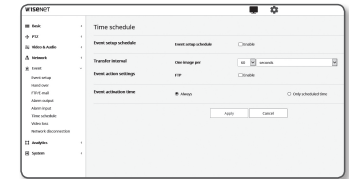

## Video loss

You can set the camera so that the camera can trigger an alarm to notify the user if the video has been lost due to disconnection with the camera.

1. From the Setup menu, select the <Event (🏠)> tab.

2. Click <Video loss>.

3. Select the channel to set.

4. Set whether or not to <Enable>.

5. Configure the event motion schedule and event motion conditions.

- For more information about <Event activation time> and <Event action settings>, refer to "Alarm input". (page 38)

6. When done, click [Apply].

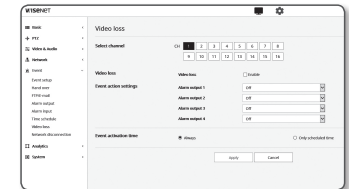

## Network disconnection

When the network is physically disconnected, it is considered as an event to be saved.

1. From the Setup menu, select the <Event (  )> tab.
2. Click <Network disconnection>.
3. Set whether or not to <Enable>.
4. Configure the event motion schedule and event motion conditions.
  - For more information about <Event activation time> and <Event action settings>, refer to "Alarm input". (page 38)
5. When done, click [Apply].

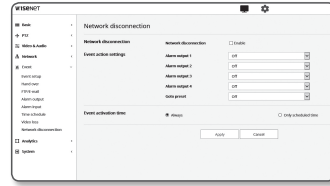

## CONFIGURE ANALYSIS SETTINGS

### Motion detection

You can configure settings to generate an event signal when a motion is detected.

1. From the Setup menu, select the <Analytics (  )> tab.
2. Click <Motion detection>.
3. Select the channel to set.
4. Set whether or not to <Enable Motion detection>.
5. Set an <Area> and <Exclude area>.

You can set up to 8 areas.  
You can specify level and sensitivity settings separately for each area.  
A single area supports a shape with up to 8 vertices.  
Select 4 vertices on the video using the mouse to create a rectangle, and select each line of the rectangle and add up to 4 more points to create a desired shape.
6. Configure settings for each item.
  - Sensitivity : Sets the sensitivity of motion detection for each area. Decrease the sensitivity in an environment where the background and the object are clearly distinguished, and increase the sensitivity in a dark environment where the background and the object cannot be clearly distinguished.
7. Select whether or not to use the hand over.

When a motion is detected in the set detection area, a specific camera moves to a specific PTZ preset position.

  - You can specify cameras by detection area.
8. Configure the event motion schedule and event motion conditions.
  - For more information about <Event activation time> and <Event action settings>, refer to "Alarm input". (page 38)
9. When done, click [Apply].

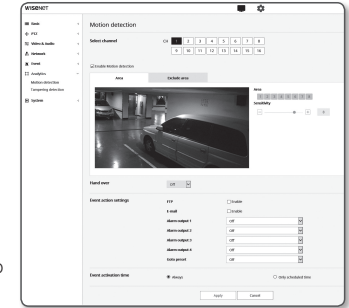

- Use continuous recording rather than motion detection event recording in areas where motion detection is frequent.
- Since the log is recorded once every 5 minutes, the buffered motion detection log data may be damaged when the power is turned off.
- Detected size of an object may have difference with the actual size according to its shape.
- In the following cases, motion detection performance may be impaired or a malfunction may occur.
  - The object color or brightness is similar to the background.
  - Small activities around the border area of the camera's field of view.
  - Multiple movements continue occurring at random due to a scene change, rapid lighting changes or other reasons.
  - A fixed object continues moving in the same position.
  - Motions of less position changing such as approaching to the camera or fading away from the camera.
  - Moving object approaches to the camera too close
  - An object hides other objects behind.
  - Too fast object (for a proper detection, one object should be found overlapping between contiguous frames).
  - Reflection / blur / shadow due to a strong light such as direct sunlight, illumination, or headlamp.
  - In severe snow, rain, wind or in dawn / dusk.

## Tampering detection

You can set to detect tampering attempts and trigger events, such as sudden change of camera's framing direction, blocked lens and other overall change of scenes from the video.

1. From the Setup menu, select the **<Analytics ( )>** tab.
2. Click **<Tampering detection>**.
3. Select the channel to set.
4. Set whether or not to **<Enable Tampering detection>**.
5. Set the sensitivity.  
The higher the set value, the more sensitive the camera reaction (range: 1 to 3).
6. Select whether or not to use the hand over.
7. Configure the event motion schedule and event motion conditions.
  - For more information about **<Event activation time>** and **<Event action settings>**, refer to "Alarm input". (page 38)
8. When done, click **[Apply]**.

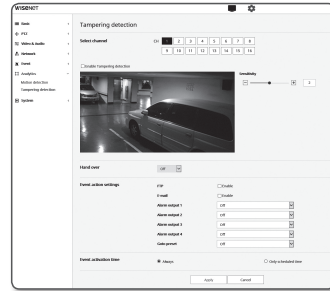

- The detection will be restarted after stabilization for a certain period of time (about 5 seconds). During stabilization, detection is not available.
- If false alarms are frequently generated, you should gradually decrease the sensitivity to minimize false alarms.
- If you use a low sensitivity, alarms may be generated even by very small changes on the screen, but false detection may occur in response to changes in moving objects or brightness.
- In the following cases, the tampering detection function may malfunction.
  - Monitoring environment with simple background, night and low light level environment.
  - Severe camera vibration or sudden lighting changes

## SYSTEM SETUP

### Product information

1. From the Setup menu, select the **<System ( )>** tab.
  2. Click **<Product information>**.
  3. Check the encoder information or enter the appropriate details for the installation environment.
    - Model : Model name of the product.
    - Serial number : Product serial number.
    - Device name : Provide a device name that will be displayed on the Live screen.
    - Location : Specify the location where the encoder is installed.
    - Description : Provide detailed information about the encoder location.
    - Memo : Provide an explanation about the encoder for better understanding.
    - Language : Select a preferred language for the Web Viewer OSD.
- The default language is set to **<English>**.
  - Device Type : Set the type of product.  
For more details, see "**Device Type setup guide**". (Page 43)

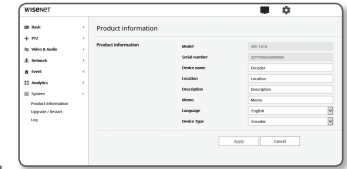

4. When done, click **[Apply]**.

### Upgrade / Restart

1. From the Setup menu, select the **<System ( )>** tab.
2. Click **<Upgrade / Restart>**.
3. Select a desired item and set it appropriately.
  - Upgrade : Performs upgrading the system.  
When reconnecting, the web viewer will not run normally if the browser cache is not completely clear.
  - Factory default : Initializes all setting information including the encoder settings to the factory reset state. (however, logs are not initialized)
    - If you select the **<Except network parameter>** check box, the network settings will be excluded and reset.
      - The IP addressing system will be defaulted to DHCP if you reset the encoder. If no DHCP server is found, the previous settings will be restored automatically.
  - Configuration backup & Restore : Backs up the current system settings before performing the restoration process. The system is automatically restarts after backup or restoration.
  - Restart : Restarts the system.

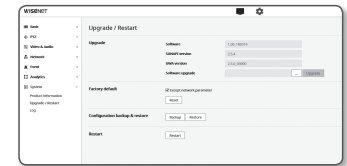



### To perform the upgrade

1. Click [**Browse** (  )] and specify a file to upgrade.
2. Click [**Upgrade**].
3. An "Upgrade" progress bar is prompted to show the upgrading status.
4. Once completed upgrading, the browser exits and the encoder restarts.

-  ■ It may take a max of 10 minutes for the upgrade process.  
If you forcibly terminate the upgrade process, upgrade will not be completed properly.
- During restarting the system, accessing with web viewer will not be made.
- You can download the latest version from the Hanwha Techwin web site.

### To back up the current settings

1. Click [**Backup**].
2. A file in a ".bin" file format is saved in "Library" -> "Document" -> "Downloads".

### To restore the backup settings

1. To restore the backup settings, click [**Restore**].
2. Select a desired backup file.

-  ■ If you perform the backup or restoration, the web browser will be closed and the encoder will reboot.
- If you try to recover the config file backed up in other model, some functions may malfunction and you need to change the setting manually.

### Log

You can check the system log or event log.

1. From the Setup menu, select the <System (  )> tab.
2. Click <Log>.
3. Select a log type.
  - Access Log : You can check the log information that contains the user's access and the access time.
  - System log : You can check the system logs where any system changes are recorded including the time information.
  - Event log : You can check the event logs including the time information.
4. From the right log list, select an item to search for.
  - If you select <All> in the top left dropdown list, all logs for the applicable log type will be displayed.
5. If one page can not display all the logs available, use the bottom buttons to move to the previous, next, or the last item.
6. Click on the <Backup> button to save all the log data for the currently selected mode in the "time stamp value create by encoder in modelname-mode-encoder.txt file" in the download folder for the browser.

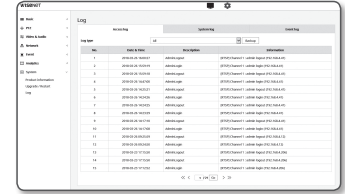

-  ■ Each page displays 15 logs with the latest one displayed at the top.
- Each log contains up to 1,000 records and after 1,000 records are saved, the oldest log is deleted when a new record is generated.

**SPECIFICATION**

Items		Description	
		SPE-1610	SPE-410
Video	Input Channel	16CH BNC	4CH BNC
	Input Signal & Resolution	CVBS, AHD(1&2&4MP), CVI(1&2MP), TVI(1&2MP) Auto Detection	
	Video Out	1 HDMI OUT (16 multi Image, 1920x1080)	1 HDMI OUT (4 multi Image, 1920x1080)
Operational	Motion Detection	Off/ On	
	Privacy Masking	Off / On (4ea rectangular zones)	
	Alarm I/O	Input 16ea / Output 4ea	Input 4ea / Output 1ea
	Alarm Triggers	Motion Detection, Alarm Input, Video Loss, Tampering, Network disconnect	
	Alarm events	File upload via FTP, E-Mail	
	Audio I/O	4 Line Input / 1 Line Output	
	Remote Control Interface	1ea RS-485(Half Duplex)	
	RS-485 Protocol	SAMSUNG-T, PELCO-P/D	
	Coaxial Control	CVBS : Pelco-C (Coaxitron) AHD : ACP(AHD Coax Protocol)	
	Network	Ethernet	RJ-45 (10/100/1000BASE-T)
Video Compression Format		H.264/MJPEG	
Resolution		NTSC : 2560x1440, 1920x1080, 1280x720, 928x480, 704x480, 928x240, 704x240, 352x240	
		PAL : 2560x1440, 1920x1080, 1280x720, 928x576, 704x576, 928x288, 704x288, 352x288	
Max. Framerate	<b>NTSC</b> 4M Camera H.264 15fps/CH : 2560x1440, 1920x1080 H.264 30fps/CH : 1280x720, 928x480, 704x480, 928x240, 704x240, 352x240 MJPEG 2fps/CH : all resolutions  2M/SD Camera H.264 30fps/CH : 1920x1080, 1280x720, 928x480, 704x480, 928x240, 704x240, 352x240 MJPEG 2fps/CH : all resolutions		

Items	Description		
	SPE-1610	SPE-410	
Network	Max. Framerate	<b>PAL</b> 4M Camera H.264 15fps/CH : 2560x1440, 1920x1080 H.264 25fps/CH : 1280x720, 928x480, 704x480, 928x240, 704x240, 352x240 MJPEG 2fps/CH : all resolutions  2M/SD Camera H.264 25fps/CH : 1920x1080, 1280x720, 928x480, 704x480, 928x240, 704x240, 352x240 MJPEG 2fps/CH : all resolutions	
		H.264 : Target Bitrate Level Control MJPEG : Quality Level Control	
	Bitrate Control Method	H.264 : CBR or VBR MJPEG : CBR	
	Streaming Capability	Dual Streaming (Up to 3 Profiles per channel, 2 H.264 + 1 MJPEG)	
	Audio Compression Format	G.711 μ-law	
	Audio Communication	Bi-directional (2-Way)	
	IP	IPv4, IPv6	
	Protocol	TCP/IP, UDP/IP, RTP(UDP), RTP(TCP), RTCP,RTSP, NTP, HTTP, HTTPS, SSL/TLS, DHCP, PPPoE, FTP, SMTP, ICMP, IGMP, SNMPv1/v2c/v3(MIB-2), ARP, DNS, DDNS, QoS, PIM-SM, UPnP, ONVIF, Bonjour	
	Security	HTTPS(SSL) Login Authentication Digest Login Authentication IP Address Filtering User access Log 802.1x Authentication (EAP-TLS, EAP-LEAP)	
		Streaming Method	Unicast / Multicast
	Max. User Access	48 users(4 Users/CH) at Unicast Mode	16 users(4 Users/CH) at Unicast Mode
	Performance	Recommended bandwidth: 60Mbps, Recommended frame rate: 600fps, Recommended connected sessions: 40 ※ If the recommended bandwidth / frame rate / connected sessions is exceeded, some frames may be lost.	

Items		Description	
		SPE-1610	SPE-410
Network	Application Programming Interface	ONVIF Profile S SUNAPI (HTTP API)	
	Webpage Language	English, Korean, French, German, Spanish, Italian, Chinese, Russian, Japanese, Swedish, Portuguese, Czech, Polish, Turkish, Dutch, Hungarian, Greek	
	Web Viewer	Supported OS : Windows 7 / 8 / 10, MAC OS X 10.10, 10.11, 10.12 <b>Plug-in free web viewer</b> Supported web browsers : Google Chrome 54, MS Edge 38, MS IE 11, Mozilla Firefox 49 (Window 64bit only) , Apple Safari 9 (Mac OS X only)	
	Interworking software and systems	SmartViewer, SSM, WiseNet Mobile Viewer, NVR* Hanwha Techwin NVR P,X,Q series)	
Environmental	Operating Temperature / Humidity	-10°C ~ +45°C (14°F ~ +113°F) / 20% ~ 80% RH	-10°C ~ +50°C (14°F ~ +122°F) / 20% ~ 80% RH
		(-10°C ~ +40°C (14°F ~ 104°F) / 20% ~ 80% RH, When installing Rack)	
Electrical	Input Voltage / Current	DC12V	DC12V, PoE(IEEE 802.3af)
	Power Consumption	MAX. 24W (12V, 2A)	MAX. 9.6W (12V, 0.8A)
Mechanical	Color / Material	Black / Metal	Dark Gray / Metal
	Dimension	W370.0 x H47.5 x D320mm	W178.0 x H34.0 x D127.8mm
	Weight	2,250g	540g

## DETAILED SUPPORTED SPECIFICATIONS OF THE WEB VIEWER

Category	Windows 7	Windows 10	Windows 7/10			Mac	
	IE 11		Edge	Chrome	Firefox	Safari (Ver. 10.1 or later / Ver. 11 or later)	
Live function	Capture	Supported	Supported	Supported	Supported	Supported	Not supported (supported / supported)
	Instance Recoding	Not supported	Not supported	Supported	Supported	Supported	Not supported (supported / supported)
	Pixel Count	Supported	Supported	Supported	Supported	Supported	Supported(Supported/Supported)
	Event display	Supported	Supported	Supported	Supported	Supported	Supported(Supported/Supported)
	Listen	Not supported	Not supported	Supported	Supported	Supported	Supported(Supported/Supported)
Common settings	Talk	Not supported	Not supported	Supported	Supported	Supported	Not supported(Not supported/Supported)
	All functions	Supported	Supported	Supported	Supported	Supported	Supported

## DEVICE TYPE SETUP GUIDE

See the table below to connect your encoder to SSM.

For more details, see "Setting up the system" in the manual.

	SSM 2.0 lower	SSM 2.1 higher
Device type	NWC	Encoder

PRODUCT OVERVIEW

SPE-410

Unit : mm [inch]

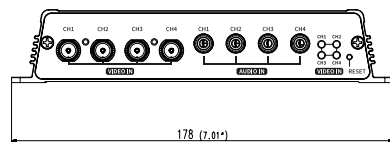
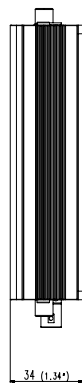
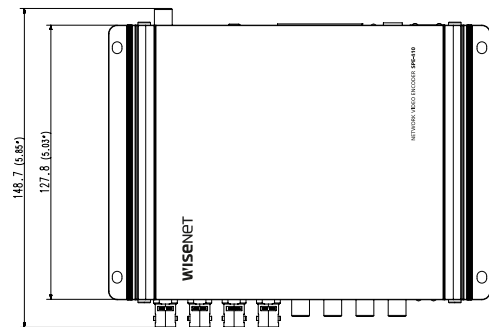

SPE-1610

Unit : mm [inch]

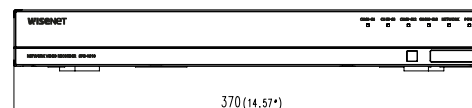
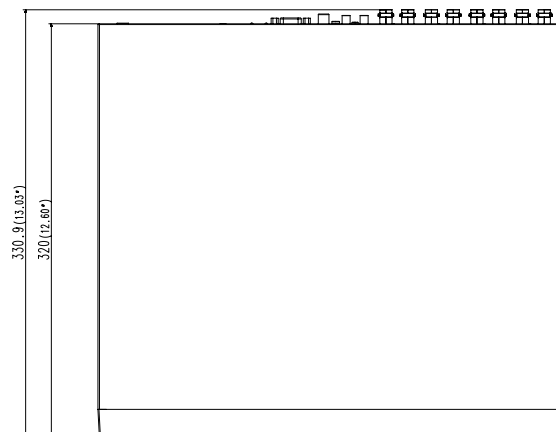
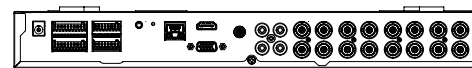

## TROUBLESHOOTING

PROBLEM	SOLUTION
When an Windows 10 user accesses the web viewer through Chrome or Firefox, the sound volume of microphone changes periodically.	<ul style="list-style-type: none"> <li>This is what happens when microphone driver has been set to Realtek driver. Install the High Definition Audio device (Windows Default Driver) or the third party driver as the microphone driver.</li> </ul>
No video is displayed when accessing the plug-in free webviewer on Safari via HTTPS.	<ul style="list-style-type: none"> <li>On the authentication popup window prompted when initially accessing https, click "View Authentication Certificate" and select the "Always trust when connecting to the designated webviewer IP" check box.</li> <li>If the webviewer continues failing to display a video after you select "Next" on the message window below, press the command key + Q to exit the Safari browser, access again and follow the procedures stated above.</li> </ul>
I can't access the encoder from a web browser.	<ul style="list-style-type: none"> <li>Check to make sure that the encoder's Network settings are appropriate.</li> <li>Check to make sure that all network cables have been connected properly.</li> <li>If connected using DHCP, verify that the encoder is able to acquire dynamic IP addresses without any problem.</li> <li>If the encoder is connected to a Broadband Router, verify that port forwarding is properly configured.</li> </ul>
Viewer got disconnected during monitoring.	<ul style="list-style-type: none"> <li>Connected Viewers become disconnected upon any change to encoder or network configurations.</li> <li>Check all network connections.</li> <li>If the encoder is connected over an PPPoE network, it's possible for Viewer to disconnect under poor network conditions.</li> </ul>
The encoder connected to the network is not detected in the IP installer program.	<ul style="list-style-type: none"> <li>Turn off the firewall settings on your PC and then search the encoder again.</li> </ul>
Images overlap.	<ul style="list-style-type: none"> <li>Check whether two or more encoders are set to a single multicast address instead of different addresses. If a single address is used for multiple encoders, the images may overlap.</li> </ul>

PROBLEM	SOLUTION
No image appears.	<ul style="list-style-type: none"> <li>If the transmission method is set to multicast, check whether there is a router that supports multicast in the LAN the encoder is connected to.</li> </ul>
Voice is not recorded even though audio input settings are configured.	<ul style="list-style-type: none"> <li>You must select the &lt;Audio-In&gt; check box in &lt;Basic&gt;-&lt;Video Profile&gt;.</li> </ul>
<Motion detection> of <Analytics> is set to <Enable>, but no notification e-mail reaches me even when an analysis event had occurred.	<ul style="list-style-type: none"> <li>Verify the settings in the following sequence:               <ol style="list-style-type: none"> <li>Check &lt;Data &amp; Time&gt; settings.</li> <li>The &lt;Motion detection&gt; should be set to &lt;Enable&gt;.</li> <li>Check if the &lt;E-mail&gt; option of &lt;Event setup&gt; menu is checked to use.</li> </ol> </li> </ul>
The system does not turn on and the indicator on the front panel does not work at all.	<ul style="list-style-type: none"> <li>Check if the power supply system is properly connected.</li> <li>Check the system for the input voltage from the power source.</li> <li>If the problem persists even after you have taken the above actions, check the power supplier and replace it with a new one if necessary.</li> </ul>
Video is being input, but some channels do not output video and instead output a video loss screen.	<ul style="list-style-type: none"> <li>Check if the camera connected to the encoder properly displays the image. Sometimes, this problem may occur on a camera that is not properly connected to the video source.</li> <li>Check if the camera is properly supplied with power.</li> <li>Sometimes, this problem may occur on a channel with weak video signal from a video distributor that is connected to multiple systems. In this case, input the video source of the camera directly into the encoder. This may find the cause and solve the problem.</li> </ul>
No response is made even if I click the [PTZ] menu on the Live screen.	<ul style="list-style-type: none"> <li>Setup → PTZ → External PTZ → Check if the current protocols and other settings in the PTZ device are properly configured according to the PTZ camera.</li> </ul>
I forgot the password.	<ul style="list-style-type: none"> <li>Contact the encoder administrator for help.</li> <li>Perform a factory reset by pressing the [RESET] button. Please note that this will also initialize the setting values.</li> </ul>

# OPEN SOURCE ANNOUNCEMENT

## GPL/LGPL software license

The software included in this product contains copyrighted software that is licensed under the GPL/LGPL. You may obtain the complete Corresponding Source code from us for a period of three years after our last shipment of this product by sending email to [help.cctv@hanwha.com](mailto:help.cctv@hanwha.com)

If you want to obtain the complete Corresponding Source code in the physical medium such as CD-ROM, the cost of physically performing source distribution might be charged.

## GPL SW

Component Name	License	URL
Base Kernel	GPL 2.0	
Busybox	GPL 2.0	<a href="http://www.busybox.net/downloads/snapshots">http://www.busybox.net/downloads/snapshots</a>
iproute2-4.3.0	GPL 2.0	
iptables-1.4.21	GPL 2.0	<a href="http://ftp.netfilter.org/pub/iptables">http://ftp.netfilter.org/pub/iptables</a>
ethtool-4.2	GPL 2.0	
mtd-1.5.2	GPL 2.0	<a href="ftp://ftp.infradead.org/pub/mtd-utils">ftp://ftp.infradead.org/pub/mtd-utils</a>
mi-diag-2.11	GPL 2.0	
rp-pppoe-3.11	GPL 2.0	<a href="http://www.roaringpenguin.com/pppoe/">http://www.roaringpenguin.com/pppoe/</a>
wpa_supplicant-2.5	GPL 2.0	
bash-4.3.30	GPL 3.0	
zeroconf	GPL 2.0	

## LGPL SW

Component Name	License	URL
glibc	LGPL 2.0	
inetutils	LGPL 3.0	
neon-0.29.6	LGPL 2.0	<a href="http://www.webdav.org/neon/">http://www.webdav.org/neon/</a>

## GNU GENERAL PUBLIC LICENSE

Version 2, June 1991

Copyright (C)1989, 1991 Free Software Foundation, Inc. 51 Franklin Street, Fifth Floor, Boston, MA 02110-1301, USA

Everyone is permitted to copy and distribute verbatim copies of this license document, but changing it is not allowed.

### Preamble

The licenses for most software are designed to take away your freedom to share and change it. By contrast, the GNU General Public License is intended to guarantee your freedom to share and change free software—to make sure the software is free for all its users. This General Public License applies to most of the Free Software Foundation's software and to any other program whose authors commit to using it. (Some other Free Software Foundation software is covered by the GNU Lesser General Public License instead.) You can apply it to your programs, too. When we speak of free software, we are referring to freedom, not price. Our General Public Licenses are designed to make sure that you have the freedom to distribute copies of free software (and charge for this service if you wish), that you receive source code or can get it if you want it, that you can change the software or use pieces of it in new free programs; and that you know you can do these things.

To protect your rights, we need to make restrictions that forbid anyone to deny you these rights or to ask you to surrender the rights. These restrictions translate to certain responsibilities for you if you distribute copies of the software, or if you modify it.

For example, if you distribute copies of such a program, whether gratis or for a fee, you must give the recipients all the rights that you have.

You must make sure that they, too, receive or can get the source code. And you must show them these terms so they know their rights. We protect your rights with two steps:

(1) Copyright the software, and (2) offer you this license which gives you legal permission to copy, distribute and/or modify the software. Also, for each author's protection and ours, we want to make certain that everyone understands that there is no warranty for this free software. If the software is modified by someone else and passed on, we want its recipients to know that what they have is not the original, so that any problems introduced by others will not reflect on the original authors' reputations.

Finally, any free program is threatened constantly by software patents. We wish to avoid the danger that redistributors of a free program will individually obtain patent licenses, in effect making the program proprietary. To prevent this, we have made it clear that any patent must be licensed for everyone's free use or not licensed at all. The precise terms and conditions for copying, distribution and modification follow.

### TERMS AND CONDITIONS FOR COPYING, DISTRIBUTION AND MODIFICATION

Version 2, June 1991 Copyright (C) 1989, 1991 Free Software Foundation, Inc. 51 Franklin St

0. This License applies to any program or other work which contains a notice placed by the copyright holder saying it may be distributed under the terms of this General Public License.

The "Program", below, refers to any such program or work, and a "work based on the Program" means either the Program or any derivative work under copyright law: that is to say, a work containing the Program or a portion of it, either verbatim or with modifications and/or translated into another language. (Hereinafter, translation is included without limitation in the term "modification".) Each licensee is addressed as "you".

Activities other than copying, distribution and modification are not covered by this License; they are outside its scope. The act of running the Program is not restricted, and the output from the Program is covered only if its contents constitute a work based on the Program (independent of having been made by running the Program). Whether that is true depends on what the Program does.

1. You may copy and distribute verbatim copies of the Program's source code as you receive it, in any medium, provided that you conspicuously and appropriately publish on each copy an appropriate copyright notice and disclaimer of warranty; keep intact all the notices that refer to this License and to the absence of any warranty; and give any other recipients of the Program a copy of this License along with the Program. You may charge a fee for the physical act of transferring a copy, and you may at your option offer warranty protection in exchange for a fee.

2. You may modify your copy or copies of the Program or any portion of it, thus forming a work based on the Program, and copy and distribute such modifications or work under the terms of Section 1 above, provided that you also meet all of these conditions:

- You must cause the modified files to carry prominent notices stating that you changed the files and the date of any change.
- You must cause any work that you distribute or publish, that in whole or in part contains or is derived from the Program or any part thereof, to be licensed as a whole at no charge to all third parties under the terms of this License.
- If the modified program normally reads commands interactively when run, you must cause it, when started running for such interactive use in the most ordinary way, to print or display an announcement including an appropriate copyright notice and a notice that there is no warranty (or else, saying that you provide a warranty) and that users may redistribute the program under these conditions, and telling the user how to view a copy of this License. (Exception: if the Program itself is interactive but does not normally print such an announcement, your work based on the Program is not required to print an announcement.)

These requirements apply to the modified work as a whole. If identifiable sections of that work are not derived from the Program, and can be reasonably considered independent and separate works in themselves, then this License, and its terms, do not apply to those sections when you distribute them as separate works. But when you distribute the same sections as part of a whole which is a work based on the Program, the distribution of the whole must be on the terms of this License, whose permissions for other licensees extend to the entire whole, and thus to each and every part regardless of who wrote it.

Thus, it is not the intent of this section to claim rights or contest your rights to work written entirely by you; rather, the intent is to exercise the right to control the distribution of derivative or collective works based on the Program. In addition, mere aggregation of another work not based on the Program with the Program (or with a work based on the Program) on a volume of a storage or distribution medium does not bring the other work under the scope of this License.

3. You may copy and distribute the Program (or a work based on it, under Section 2) in object code or executable form under the terms of Sections 1 and 2 above provided that you also do one of the following:

- Accompany it with the complete corresponding machine-readable source code, which must be distributed under the terms of Sections 1 and 2 above on a medium customarily used for software interchange; or,
- Accompany it with a written offer, valid for at least three years, to give any third party, for a charge no more than your cost of physically performing source distribution, a complete machine-readable copy of the corresponding source code, to be distributed under the terms of Sections 1 and 2 above on a medium customarily used for software interchange; or,
- Accompany it with the information you received as to the offer to distribute corresponding source code. (This alternative is allowed only for noncommercial distribution and only if you received the program in object code or executable form with such an offer, in accord with Subsection b above.) The source code for a work means the preferred form of the work for making modifications to it. For an executable work, complete source code means all the source code for all modules it contains, plus any associated interface definition files, plus the scripts used to control compilation and installation of the executable. However, as a special exception, the source code distributed need not include anything that is normally distributed (in either source or binary form) with the major

components (compiler, kernel, and so on) of the operating system on which the executable runs, unless that component itself accompanies the executable. If distribution of executable or object code is made by offering access to copy from a designated place, then offering equivalent access to copy the source code from the same place counts as distribution of the source code, even though third parties are not compelled to copy the source along with the object code.

4. You may not copy, modify, sublicense, or distribute the Program except as expressly provided under this License. Any attempt otherwise to copy, modify, sublicense or distribute the Program is void, and will automatically terminate your rights under this License.

However, parties who have received copies, or rights, from you under this License will not have their licenses terminated so long as such parties remain in full compliance.

5. You are not required to accept this License, since you have not signed it. However, nothing else grants you permission to modify or distribute the Program or its derivative works.

These actions are prohibited by law if you do not accept this License. Therefore, by modifying or distributing the Program (or any work based on the Program), you indicate your acceptance of this License to do so, and all its terms and conditions for copying, distributing or modifying the Program or works based on it.

6. Each time you redistribute the Program (or any work based on the Program), the recipient automatically receives a license from the original licensor to copy, distribute or modify the Program subject to these terms and conditions. You may not impose any further restrictions on the recipients' exercise of the rights granted herein. You are not responsible for enforcing compliance by third parties to this License.

7. If, as a consequence of a court judgment or allegation of patent infringement or for any other reason (not limited to patent issues), conditions are imposed on you (whether by court order, agreement or otherwise) that contradict the conditions of this License, they do not excuse you from the conditions of this License. If you cannot distribute so as to satisfy simultaneously your obligations under this License and any other pertinent obligations, then as a consequence you may not distribute the Program at all.

For example, if a patent license would not permit royalty-free redistribution of the Program by all those who receive copies directly or indirectly through you, then the only way you could satisfy both it and this License would be to refrain entirely from distribution of the Program.

If any portion of this section is held invalid or unenforceable under any particular circumstance, the balance of the section is intended to apply and the section as a whole is intended to apply in other circumstances. It is not the purpose of this section to induce you to infringe any patents or other property right claims or to contest validity of any such claims; this section has the sole purpose of protecting the integrity of the free software distribution system, which is implemented by public license practices. Many people have made generous contributions to the wide range of software distributed through that system in reliance on consistent application of that system; it is up to the author/donor to decide if he or she is willing to distribute software through any other system and a licensee cannot impose that choice. This section is intended to make thoroughly clear what is believed to be a consequence of the rest of this License.

8. If the distribution and/or use of the Program is restricted in certain countries either by patents or by copyrighted interfaces, the original copyright holder who places the Program under this License may add an explicit geographical distribution limitation excluding those countries, so that distribution is permitted only in or among countries not thus excluded. In such case, this License incorporates the limitation as if written in the body of this License.

9. The Free Software Foundation may publish revised and/or new versions of the General Public License from time to time. Such new versions will be similar in spirit to the present version, but may differ in detail to address new problems or concerns. Each version is given a distinguishing version number. If the Program specifies a version number of this License which applies to it and "any later version", you have the option of following the terms and conditions either of that version or of any later version published by the Free Software Foundation. If the Program does not specify a version number of this License, you may choose any version ever published by the Free Software Foundation.

10. If you wish to incorporate parts of the Program into other free programs whose distribution conditions are different, write to the author to ask for permission. For software which is copyrighted by the Free Software Foundation, write to the Free Software Foundation; we sometimes make exceptions for this. Our decision will be guided by the two goals of preserving the free status of all derivatives of our free software and of promoting the sharing and reuse of software generally.

## NO WARRANTY

11. BECAUSE THE PROGRAM IS LICENSED FREE OF CHARGE, THERE IS NO WARRANTY FOR THE PROGRAM, TO THE EXTENT PERMITTED BY APPLICABLE LAW. EXCEPT WHEN OTHERWISE STATED IN WRITING THE COPYRIGHT HOLDERS AND/OR OTHER PARTIES PROVIDE THE PROGRAM "AS IS" WITHOUT WARRANTY OF ANY KIND, EITHER EXPRESSED OR IMPLIED, INCLUDING, BUT NOT LIMITED TO, THE IMPLIED WARRANTIES OF MERCHANTABILITY AND FITNESS FOR A PARTICULAR PURPOSE. THE ENTIRE RISK AS TO THE QUALITY AND PERFORMANCE OF THE PROGRAM IS WITH YOU. SHOULD THE PROGRAM PROVE DEFECTIVE, YOU ASSUME THE COST OF ALL NECESSARY SERVICING, REPAIR OR CORRECTION.

12. IN NO EVENT UNLESS REQUIRED BY APPLICABLE LAW OR AGREED TO IN WRITING WILL ANY COPYRIGHT HOLDER, OR ANY OTHER PARTY WHO MAY MODIFY AND/OR REDISTRIBUTE DAMAGES, INCLUDING ANY GENERAL, SPECIAL, INCIDENTAL OR CONSEQUENTIAL DAMAGES ARISING OUT OF THE USE OR THE PROGRAM (INCLUDING BUT NOT LIMITED TO LOSS OF DATA OR DATA BEING RENDERED INACCURATE OR LOSSES SUSTAINED BY YOU OR THIRD PARTIES OR A FAILURE OF THE PROGRAM TO OPERATE WITH ANY OTHER PROGRAMS), EVEN IF SUCH HOLDER OR OTHER PARTY HAS BEEN ADVISED OF THE POSSIBILITY OF SUCH DAMAGES.

## END OF TERMS AND CONDITIONS

How to Apply These Terms to Your New Programs If you develop a new program, and you want it to be of the greatest possible use to the public, the best way to achieve this is to make it free software which everyone can redistribute and change under these terms. To do so, attach the following notices to the program. It is safest to attach them to the start of each source file to most effectively convey the exclusion of warranty; and each file should have at least the "copyright" line and a pointer to where the full notice is found. one line to give the program's name and an idea of what it does.

Copyright (C)yyyy name of author

This program is free software; you can redistribute it and/or modify it under the terms of the GNU General Public License as published by the Free Software Foundation; either version 2 of the License, or (at your option) any later version.

This program is distributed in the hope that it will be useful, but WITHOUT ANY WARRANTY; without even the implied warranty of MERCHANTABILITY or FITNESS FOR A PARTICULAR PURPOSE. See the GNU General Public License for more details.

You should have received a copy of the GNU General Public License along with this program; if not, write to the Free Software Foundation, Inc., 51 Franklin Street, Fifth Floor, Boston, MA 02110-1301, USA.

Also add information on how to contact you by electronic and paper mail. If the program is interactive, make it output a short notice like this when it starts in an interactive mode:

Gnomovision version 69, Copyright (C) year name of author Gnomovision comes with ABSOLUTELY NO WARRANTY; for details type 'show w'. This is free software, and you are welcome to redistribute it under certain conditions; type 'show c' for details.

The hypothetical commands 'show w' and 'show c' should show the appropriate parts of the General Public License. Of course, the commands you use may be called something other than 'show w' and 'show c'; they could even be mouse-clicks or menu items—whatever suits your program.

You should also get your employer (if you work as a programmer) or your school, if any, to sign a "copyright disclaimer" for the program, if necessary. Here is a sample; alter the names:

Yooyodny, Inc., hereby disclaims all copyright interest in the program 'Gnomovision' (which makes passes at compilers) written by James Hacker. signature of Ty Coon, 1 April 1989 Ty Coon, President of Vice This General Public License does not permit incorporating your program into proprietary programs. If your program is a subroutine library, you may consider it more useful to permit linking proprietary applications with the library. If this is what you want to do, use the GNU Lesser General Public License instead of this License.

## GNU GENERAL PUBLIC LICENSE

Version 3, 29 June 2007

Copyright (C) 2007 Free Software Foundation, Inc. <<http://fsf.org/>>

Everyone is permitted to copy and distribute verbatim copies of this license document, but changing it is not allowed.

### Preamble

The GNU General Public License is a free, copyleft license for software and other kinds of works. The licenses for most software and other practical works are designed to take away your freedom to share and change the works. By contrast, the GNU General Public License is intended to guarantee your freedom to share and change all versions of a program—to make sure it remains free software for all its users.

We, the Free Software Foundation, use the GNU General Public License for most of our software; it applies also to any other work released this way by its authors.

You can apply it to your programs, too. When we speak of free software, we are referring to freedom, not price. Our General Public Licenses are designed to make sure that you have the freedom to distribute copies of free software (and charge for them if you wish), that you receive source code or can get it if you want it, that you can change the software or use pieces of it in new free programs, and that you know you can do these things.

To protect your rights, we need to prevent others from denying you these rights or asking you to surrender the rights. Therefore, you have certain responsibilities if you distribute copies of the software, or if you modify it: responsibilities to respect the freedom of others. For example, if you distribute copies of such a program, whether gratis or for a fee, you must pass on to the recipients the same freedoms that you received. You must make sure that they, too, receive or can get the source code. And you must show them these terms so they know their rights. Developers that use the GNU GPL protect your rights with two steps: (1) assert copyright on the software, and (2) offer you this License giving you legal permission to copy, distribute and/or modify it. For the developers' and authors' protection, the GPL clearly explains that there is noarranty for this free software. For both users' and authors' sake, the GPL requires that modified versions be marked as changed, so that their problems will not be attributed erroneously to authors of previous versions. Some devices are designed to deny users access to install or run modified versions of the software inside them, although the manufacturer can do so. This is fundamentally incompatible with the aim of protecting users' freedom to change the software. The systematic pattern of such abuse occurs in the area of products for individuals to use, which is precisely where it is most unacceptable. Therefore, we have designed this version of the GPL to prohibit the practice for those products. If such problems arise substantially in other domains, we stand ready to extend this provision to those domains in future versions of the GPL, as needed to protect the freedom of users.

Finally, every program is threatened constantly by software patents. States should not allow patents to restrict development and use of software on general-purpose computers, but in those that do, we wish to avoid the special anger that patents applied to a free program could make it effectively proprietary. To prevent this, the GPL assures that patents cannot be used to render the program non-free. It precisely terms and conditions for copying, distribution and modification follow.

## TERMS AND CONDITIONS

### 0. Definitions.

"This License" refers to version 3 of the GNU General Public License.

"Copyright" also means copyright-like laws that apply to other kinds of works, such as semiconductor masks. "The Program" refers to any copyrightable work licensed under this License. Each licensee is addressed as "you". "Licensees" and "recipients" may be individuals or organizations.

To "modify" a work means to copy from or adapt all or part of the work in a fashion requiring copyright permission, other than the making of an exact copy. The resulting work is called a "modified version" of the earlier work or a work "based on" the earlier work.

A "covered work" means either the unmodified Program or a work based on the Program.

To "propagate" a work means to do anything with it that, without permission, would make you directly or secondarily liable for infringement under applicable copyright law, except executing it on a computer or modifying a private copy.

Propagation includes copying, distribution (with or without modification), making available to the public, and in some countries other activities as well.

To "convey" a work means any kind of propagation that enables other parties to make or receive copies. Mere interaction with a user through a computer network, with no transfer of a copy, is not conveying. An interactive user interface displays "Appropriate Legal Notices" to the extent that it includes a convenient and prominently visible feature that (1) displays an appropriate copyright notice, and (2) tells the user that there is no warranty for the work (except to the extent that warranties are provided), that licensees may convey the work under this License, and how to view a copy of this License. If the interface presents a list of user commands or options, such as a menu, a prominent item in the list meets this criterion.

### 1. Source Code.

The "source code" for a work means the preferred form of the work for making modifications to it. "Object code" means any non-source form of a work.

A "Standard Interface" means an interface that either is an official standard defined by a recognized standards body, or, in the case of interfaces specified for a particular programming language, one that is widely used among developers working in that language.

The "System Libraries" of an executable work include anything, other than the work as a whole, that (a) is included in the normal form of packaging a Major Component, but which is not part of that Major Component, and (b) serves only to enable use of the work with that Major Component, or to implement a Standard Interface for which an implementation is available to the public in source code form. A "Major Component", in this context, means a major essential component (kernel, window system, and so on) of the specific operating system (if any) on which the executable work runs, or a compiler used to produce the work, or an object code interpreter used to run it.

The "Corresponding Source" for a work in object code form means all the source code needed to generate, install, and (for an executable work) run the object code and to modify the work, including scripts to control those activities.

However, it does not include the work's System Libraries, or generalpurpose tools or generally available free programs which are used unmodified in performing those activities but which are not part of the work. For example, Corresponding Source includes interface definition files associated with source files for the work, and the source code for shared libraries and dynamically linked subprograms that the work is specifically designed to require, such as by intimate data communication or control flow between those subprograms and other parts of the work.

The Corresponding Source need not include anything that users can regenerate automatically from other parts of the Corresponding Source. The Corresponding Source for a work in source code form is that same work.

## 2. Basic Permissions.

All rights granted under this License are granted for the term of copyright on the Program, and are irrevocable provided the stated conditions are met. This License explicitly affirms your unlimited permission to run the unmodified Program. The output from running a covered work is covered by this License only if the output, given its content, constitutes a covered work. This License acknowledges your rights of fair use or other equivalent, as provided by copyright law.

You may make, run and propagate covered works that you do not convey, without conditions so long as your license otherwise remains in force. You may convey covered works to others for the sole purpose of having them make modifications exclusively for you, or provide you with facilities for running those works, provided that you comply with the terms of this License in conveying all material for which you do not control copyright. These thus making or running the covered works for you must do so exclusively on your behalf, under your direction and control, on terms that prohibit them from making any copies of your copyrighted material outside their relationship with you. Conveying under any other circumstances is permitted solely under the conditions stated below. Sublicensing is not allowed; section 10 makes it unnecessary.

## 3. Protecting Users' Legal Rights From anti-Circumvention Law.

No covered work shall be deemed part of an effective technological measure under any applicable law fulfilling obligations under article 11 of the WIPO copyright treaty adopted on 20 December 1996, or similar laws prohibiting or restricting circumvention of such measures.

When you convey a covered work, you waive any legal power to forbid circumvention of technological measures to the extent such circumvention is effected by exercising rights under this License with respect to the covered work, and you disclaim any intention to limit operation or modification of the work as a means of enforcing, against the work's users, your or third parties' legal rights to forbid circumvention of technological measures.

## 4. Conveying Verbatim Copies.

You may convey verbatim copies of the Program's source code as you receive it, in any medium, provided that you conspicuously and appropriately publish on each copy an appropriate copyright notice; keep intact all notices stating that this License and any non-permissive terms added in accord with section 7 apply to the code; keep intact all notices of the absence of any warranty; and give all recipients a copy of this License along with the Program. You may charge any price or no price for each copy that you convey, and you may offer support or warranty protection for a fee.

## 5. Conveying Modified Source Versions.

You may convey a work based on the Program, or the modifications to produce it from the Program, in the form of source code under the terms of section 4, provided that you also meet all of these conditions:

- The work must carry prominent notices stating that you modified it, and giving a relevant date.
- The work must carry prominent notices stating that it is released under this License and any conditions added under section 7. This requirement modifies the requirement in section 4 to "keep intact all notices".
- You must license the entire work, as a whole, under this License to anyone who comes into possession of a copy. This License will therefore apply, along with any applicable section 7 additional terms, to the whole of the work, and all its parts, regardless of how they are packaged. This License gives no permission to license the work in any other way, but it does not invalidate such permission if you have separately received it.
- If the work has interactive user interfaces, each must display Appropriate Legal Notices; however, if the Program has interactive interfaces that do not display Appropriate Legal Notices, your work need not make them do so. A compilation of a covered work with other separate and independent works, which are not by their nature extensions of the covered work, and which are not combined with it such as to form a larger program, in or on a volume of a storage or distribution medium, is called an "aggregate" if the compilation and its resulting copyright are not used to limit the access or legal rights of the compilation's users beyond what the individual works permit. Inclusion of a covered work in an aggregate does not cause this License to apply to the other parts of the aggregate.

## 6. Conveying Non-Source Forms.

You may convey a covered work in object code form under the terms of sections 4 and 5, provided that you also convey the machine-readable Corresponding Source under the terms of this License, in one of these ways:

- Convey the object code in, or embodied in, a physical product (including a physical distribution medium), accompanied by the Corresponding Source fixed on a durable physical medium customarily used for software interchange.
- Convey the object code in, or embodied in, a physical product (including a physical distribution medium), accompanied by a written offer, valid for at least three years and valid for as long as you offer spare parts or customer support for that product model, to give anyone who possesses the object code either (1) a copy of the Corresponding Source for all the software in the product that is covered by this License, on a durable physical medium customarily used for software interchange, for a price no more than your reasonable cost of physically performing this conveying of source, or (2) access to copy the Corresponding Source from a network server at no charge.
- Convey individual copies of the object code with a copy of the written offer to provide the corresponding Source. This alternative is allowed only occasionally and noncommercially, and only if you received the object code with such an offer, in accord with subsection 6b.
- Convey the object code by offering access from a designated place (gratis or for a charge), and offer equivalent access to the Corresponding Source in the same way through the same place at no further charge. You need not require recipients to copy the Corresponding Source along with the object code. If the place to copy the object code is a network server, the Corresponding Source may be on a different server (operated by you or a third party) that supports equivalent copying facilities, provided you maintain clear directions next to the object code saying where to find the Corresponding Source. Regardless of what server hosts the Corresponding Source, you remain obligated to ensure that it is available for as long as needed to satisfy these requirements.

- Convey the object code using peer-to-peer transmission, provided you inform other peers where the object code and Corresponding Source of the work are being offered to the general public at no charge under subsection 6d. A separable portion of the object code, whose source code is excluded from the Corresponding Source as a System Library, need not be included in conveying the object code work. A "User Product" is either (1) a "consumer product", which means any tangible personal property which is normally used for personal, family, or household purposes, or (2) anything designed or sold for incorporation into a dwelling. In determining whether a product is a consumer product, doubtful cases shall be resolved in favor of coverage. For a particular product received by a particular user, "normally used" refers to a typical or common use of that class of product, regardless of the status of the particular user or of the way in which the particular user actually uses, or expects or is expected to use, the product. A product is a consumer product regardless of whether the product has substantial commercial, industrial or non-consumer uses, unless such uses represent the only significant mode of use of the product.

"Installation Information" for a User Product means any methods, procedures, authorization keys, or other information required to install and execute modified versions of a covered work in that User Product from a modified version of its Corresponding Source. The information must suffice to ensure that the continued functioning of the modified object code is in no case prevented or interfered with solely because modification has been made. If you convey an object code work under this section in, or with, or specifically for use in, a User Product, and the conveying occurs as part of a transaction in which the right of possession and use of the User Product is transferred to the recipient in perpetuity or for a fixed term (regardless of how the transaction is characterized), the Corresponding Source conveyed under this section must be accompanied by the Installation Information. But this requirement does not apply if neither you nor any third party retains the ability to install modified object code on the User Product (for example, the work has been installed in ROM).

The requirement to provide Installation Information does not include a requirement to continue to provide support service, warranty, or updates for a work that has been modified or installed by the recipient, or for the User Product in which it has been modified or installed. Access to a network may be denied when the modification itself materially and adversely affects the operation of the network or violates the rules and protocols for communication across the network. Corresponding Source conveyed, and Installation Information provided, in accord with this section must be in a format that is publicly documented (and with an implementation available to the public in source code form), and must require no special password or key for unpacking, reading or copying.

## 7. Additional Terms.

"Additional permissions" are terms that supplement the terms of this License by making exceptions from one or more of its conditions. Additional permissions that are applicable to the entire Program shall be treated as though they were included in this License, to the extent that they are valid under applicable law. If additional permissions apply only to part of the Program, that part may be used separately under those permissions, but the entire Program remains governed by this License without regard to the additional permissions. When you convey a copy of a covered work, you may at your option remove any additional permissions from that copy, or from any part of it. (Additional permissions may be written to require their own removal in certain cases when you modify the work.) You may place additional permissions on material, added by you to a covered work, for which you have or can give appropriate copyright permission. Notwithstanding any other provision of this License, for material you add to a covered work, you may (if authorized by the copyright holders of that material) supplement the terms of this License with terms:

- Disclaiming warranty or limiting liability differently from the terms of sections 15 and 16 of this License; or
- Requiring preservation of specified reasonable legal notices or author attributions in that material or in the Appropriate Legal Notices displayed by works containing it; or
- Prohibiting misrepresentation of the origin of that material, or requiring that modified versions of such material be marked in reasonable ways as different from the original version; or
- Limiting the use for publicity purposes of names of licensors or authors of the material; or
- Declining to grant rights under trademark law for use of some trade names, trademarks, or service marks; or
- Requiring indemnification of licensors and authors of that material by anyone who conveys the material (or modified versions of it) with contractual assumptions of liability to the recipient, for any liability that these contractual assumptions directly impose on those licensors and authors. All other non-permissive additional terms are considered "further restrictions" within the meaning of section 10. If the Program as you received it, or any part of it, contains a notice stating that it is governed by this License along with a term that is a further restriction, you may remove that term. If a license document contains a further restriction but permits relicensing or conveying under this License, you may add to a covered work material governed by the terms of that license document, provided that the further restriction does not survive such relicensing or conveying. If you add terms to a covered work in accord with this section, you must place, in the relevant source files, a statement of the additional terms that apply to those files, or a notice indicating where to find the applicable terms. Additional terms, permissive or non-permissive, may be stated in the form of a separately written license, or stated as exceptions; the above requirements apply either way.

## 8. Termination.

You may not propagate or modify a covered work except as expressly provided under this License. Any attempt otherwise to propagate or modify it is void, and will automatically terminate your rights under this License (including any patent licenses granted under the third paragraph of section 11).

However, if you cease all violation of this License, then your license from a particular copyright holder is reinstated (a) provisionally, unless and until the copyright holder explicitly and finally terminates your license, and (b) permanently, if the copyright holder fails to notify you of the violation by some reasonable means prior to 60 days after the cessation. Moreover, your license from a particular copyright holder is reinstated permanently if the copyright holder notifies you of the violation by some reasonable means, this is the first time you have received notice of violation of this License for any work) from that copyright holder, and you cure the violation prior to 30 days after your receipt of the notice. Termination of your rights under this section does not terminate the licenses of parties who have received copies or rights from you under this License. If your rights have been terminated and not permanently reinstated, you do not qualify to receive new licenses for the same material under section 10.

## 9. Acceptance Not Required for Having Copies.

You are not required to accept this License in order to receive or run a copy of the Program. Ancillary propagation of a covered work occurring solely as a consequence of using peer-to-peer transmission to receive a copy likewise does not require acceptance. However, nothing other than this License grants you permission to propagate or modify any covered work. These actions infringe copyright if you do not accept this License. Therefore, by modifying or propagating a covered work, you indicate your acceptance of this License to do so.

## 10. Automatic Licensing of Downstream Recipients.

Each time you convey a covered work, the recipient automatically receives a license from the original licensors, to run, modify and propagate that work, subject to this License. You are not responsible for enforcing compliance by third parties with this License. An "entity transaction" is a transaction transferring control of an organization, or substantially all assets of one, or subdividing an organization, or merging organizations. If propagation of a covered work results from an entity transaction, each party to that transaction who receives a copy of the work also receives whatever licenses to the work the party's predecessor in interest had or could give under the previous paragraph, plus a right to possession of the Corresponding Source of the work from the predecessor in interest, if the predecessor has it or can get it with reasonable efforts. You may not impose any further restrictions on the exercise of the rights granted or affirmed under this License. For example, you may not impose a license fee, royalty, or other charge for exercise of rights granted under this License, and you may not initiate litigation (including a cross-claim or counterclaim in a lawsuit) alleging that any patent claim is infringed by making, using, selling, offering for sale, or importing the Program or any portion of it.

## 11. Patents.

A "contributor" is a copyright holder who authorizes use under this License of the Program or a work on which the Program is based. The work thus licensed is called the contributor's "contributor version". A contributor's "essential patent claims" are all patent claims owned or controlled by the contributor, whether already acquired or hereafter acquired, that would be infringed by some manner, permitted by this License, of making, using, or selling its contributor version, but do not include claims that would be infringed only as a consequence of further modification of the contributor version. For purposes of this definition, "control" includes the right to grant patent sublicenses in a manner consistent with the requirements of this License. Each contributor grants you a non-exclusive, worldwide, royalty-free patent license under the contributor's essential patent claims, to make, use, sell, offer for sale, import and otherwise run, modify and propagate the contents of its contributor version.

In the following three paragraphs, a "patent license" is any express agreement or commitment, however denominated, not to enforce a patent (such as an express permission to practice a patent or covenant not to sue for patent infringement). To "grant" such a patent license to a party means to make such an agreement or commitment not to enforce a patent against the party. If you convey a covered work, knowingly relying on a patent license, and the Corresponding Source of the work is not available for anyone to copy, free of charge and under the terms of this License, through a publicly available network server or other readily accessible means, then you must either (1) cause the Corresponding Source to be so available, or (2) arrange to deprive yourself of the benefit of the patent license for this particular work, or (3) arrange, in a manner consistent with the requirements of this License, to extend the patent license to downstream recipients. "Knowingly relying" means you have actual knowledge that, but for the patent license, your conveying the covered work in a country, or your recipient's use of the covered work in a country, would infringe one or more identifiable patents in that country that you have reason to believe are valid. If, pursuant to or in connection with a single transaction or arrangement, you convey, or propagate by procuring conveyance of, a covered work, and grant a



patent license to some of the parties receiving the covered work authorizing them to use, propagate, modify or convey a specific copy of the covered work, then the patent license you grant is automatically extended to all recipients of the covered work and works based on it. A patent license is "discriminatory" if it does not include within the scope of its coverage, prohibits the exercise of, or is conditioned on the non-exercise of one or more of the rights that are specifically granted under this License. You may not convey a covered work if you are a party to an arrangement with a third party that is in the business of distributing software, under which you make payment to the third party based on the extent of your activity of conveying the work, and under which the third party grants, to any of the parties who would receive the covered work from you, a discriminatory patent license

(a) in connection with copies of the covered work conveyed by you (or copies made from those copies), or

(b) primarily for and in connection with specific products or compilations that contain the covered work, unless you entered into that arrangement, or that patent license was granted, prior to 28 March 2007. Nothing in this License shall be construed as excluding or limiting any implied license or other defenses to infringement that may otherwise be available to you under applicable patent law.

## 12. No Surrender of Others' Freedom.

If conditions are imposed on you (whether by court order, agreement or otherwise) that contradict the conditions of this License, they do not excuse you from the conditions of this License. If you cannot convey a covered work so as to satisfy simultaneously your obligations under this License and any other pertinent obligations, then as a consequence you may not convey it at all. For example, if you agree to terms that obligate you to collect a royalty for further conveying from those to whom you convey the Program, the only way you could satisfy both those terms and this License would be to refrain entirely from conveying the Program.

## 13. Use with the GNU Affero General Public License.

Notwithstanding any other provision of this License, you have permission to link or combine any covered work with a work licensed under version 3 of the GNU Affero General Public License into a single combined work, and to convey the resulting work. The terms of this License will continue to apply to the part which is the covered work, but the special requirements of the GNU Affero General Public License, section 13, concerning interaction through a network will apply to the combination as such.

## 14. Revised Versions of this License.

The Free Software Foundation may publish revised and/or new versions of the GNU General Public License from time to time. Such new versions will be similar in spirit to the present version, but may differ in detail to address new problems or concerns.

Each version is given a distinguishing version number. If the Program specifies that a certain numbered version of the GNU General Public License "or any later version" applies to it, you have the option of following the terms and conditions either of that numbered version or of any later version published by the Free Software Foundation. If the Program does not specify a version number of the GNU General Public License, you may choose any version ever published by the Free Software Foundation. If the Program specifies that a proxy can decide which future versions of the GNU General Public License can be used, that proxy's public statement of acceptance of a version permanently authorizes you to choose that version for the Program. Later license versions may give you additional or different permissions. However, no additional obligations are imposed on any author or copyright holder as a result of your choosing to follow a later version.

## 15. Disclaimer of Warranty.

THERE IS NO WARRANTY FOR THE PROGRAM, TO THE EXTENT PERMITTED BY APPLICABLE LAW. EXCEPT WHEN OTHERWISE STATED IN WRITING THE COPYRIGHT HOLDERS AND/OR OTHER PARTIES PROVIDE THE PROGRAM "AS IS" WITHOUT WARRANTY OF ANY KIND, EITHER EXPRESSED OR IMPLIED, INCLUDING, BUT NOT LIMITED TO, THE IMPLIED WARRANTIES OF MERCHANTABILITY AND FITNESS FOR A PARTICULAR PURPOSE. THE ENTIRE RISK AS TO THE QUALITY AND PERFORMANCE OF THE PROGRAM IS WITH YOU. SHOULD THE PROGRAM PROVE DEFECTIVE, YOU ASSUME THE COST OF ALL NECESSARY SERVICING, REPAIR OR CORRECTION.

## 16. Limitation of Liability.

IN NO EVENT UNLESS REQUIRED BY APPLICABLE LAW OR AGREED TO IN WRITING WILL ANY COPYRIGHT HOLDER, OR ANY OTHER PARTY WHO MODIFIES AND/OR CONVEYS THE PROGRAM AS PERMITTED ABOVE, BE LIABLE TO YOU FOR DAMAGES, INCLUDING ANY GENERAL, SPECIAL, INCIDENTAL OR CONSEQUENTIAL DAMAGES ARISING OUT OF THE USE OR INABILITY TO USE THE PROGRAM (INCLUDING BUT NOT LIMITED TO LOSS OF DATA OR DATA BEING RENDERED INACCURATE OR LOSSES SUSTAINED BY YOU OR THIRD PARTIES OR A FAILURE OF THE PROGRAM TO OPERATE WITH ANY OTHER PROGRAMS), EVEN IF SUCH HOLDER OR OTHER PARTY HAS BEEN ADVISED OF THE POSSIBILITY OF SUCH DAMAGES.

## 17. Interpretation of Sections 15 and 16.

If the disclaimer of warranty and limitation of liability provided above cannot be given local legal effect according to their terms, reviewing courts shall apply local law that most closely approximates an absolute waiver of all civil liability in connection with the Program, unless a warranty or assumption of liability accompanies a copy of the Program in return for a fee.

## OpenSSL Combined License

The OpenSSL toolkit stays under a dual license, i.e. both the conditions of the OpenSSL License and the original SSLeay license apply to the toolkit.

See below for the actual license texts. Actually both licenses are BSD-style Open Source licenses. In case of any license issues related to OpenSSL please contact openssl-core@openssl.org.

Component Name	License	URL
openssl-1.0.2e	OpenSSL	Combined License <a href="http://www.openssl.org/source">http://www.openssl.org/source</a>

Copyright (c) 1998-2011 The OpenSSL Project. All rights reserved.

Redistribution and use in source and binary forms, with or without modification, are permitted provided that the following conditions are met:

1. Redistributions of source code must retain the above copyright notice, this list of conditions and the following disclaimer.
2. Redistributions in binary form must reproduce the above copyright notice, this list of conditions and the following disclaimer in the documentation and/or other materials provided with the distribution.
3. All advertising materials mentioning features or use of this software must display the following acknowledgment: "This product includes software developed by the OpenSSL Project or use in the OpenSSL Toolkit. (<http://www.openssl.org/>)"
4. The names "OpenSSL Toolkit" and "OpenSSL Project" must not be used to endorse or promote products derived from this software without prior written permission. For written permission, please contact openssl-core@openssl.org.
5. Products derived from this software may not be called "OpenSSL" nor may "OpenSSL" appear in their names without prior written permission of the OpenSSL Project.

6. Redistributions of any form whatsoever must retain the following acknowledgment: "This product includes software developed by the OpenSSL Project for use in the OpenSSL Toolkit (<http://www.openssl.org/>)"

THIS SOFTWARE IS PROVIDED BY THE OpenSSL PROJECT "AS IS" AND ANY EXPRESSED OR IMPLIED WARRANTIES, INCLUDING, BUT NOT LIMITED TO, THE IMPLIED WARRANTIES OF MERCHANTABILITY AND FITNESS FOR A PARTICULAR PURPOSE ARE DISCLAIMED. IN NO EVENT SHALL THE OpenSSL PROJECT OR ITS CONTRIBUTORS BE LIABLE FOR ANY DIRECT, INDIRECT, INCIDENTAL, SPECIAL, EXEMPLARY, OR CONSEQUENTIAL DAMAGES (INCLUDING, BUT NOT LIMITED TO, PROCUREMENT OF SUBSTITUTE GOODS OR SERVICES; LOSS OF USE, DATA, OR PROFITS; OR BUSINESS INTERRUPTION) HOWEVER CAUSED AND ON ANY THEORY OF LIABILITY, WHETHER IN CONTRACT, STRICT LIABILITY, OR TORT (INCLUDING NEGLIGENCE OR OTHERWISE) ARISING IN ANY WAY OUT OF THE USE OF THIS SOFTWARE, EVEN IF ADVISED OF THE POSSIBILITY OF SUCH DAMAGE.

This product includes cryptographic software written by Eric Young ([ey@cryptsoft.com](mailto:ey@cryptsoft.com)). This product includes software written by Tim Hudson ([tjh@cryptsoft.com](mailto:tjh@cryptsoft.com)).

## Original SSLeay License

Copyright (C) 1995-1998 Eric Young ([ey@cryptsoft.com](mailto:ey@cryptsoft.com)) All rights reserved.

This package is an SSL implementation written by Eric Young ([ey@cryptsoft.com](mailto:ey@cryptsoft.com)).

The implementation was written so as to conform with Netscapes SSL.

This library is free for commercial and non-commercial use as long as the following conditions are adhered to. The following conditions apply to all code found in this distribution, be it the RC4, RSA, lhash, DES, etc., code; not just the SSL code. The SSL documentation included with this distribution is covered by the same copyright terms except that the holder is Tim Hudson ([tjh@cryptsoft.com](mailto:tjh@cryptsoft.com)).

Copyright remains Eric Young's, and as such any Copyright notices in the code are not to be removed. If this package is used in a product, Eric Young should be given attribution as the author of the parts of the library used. This can be in the form of a textual message at program startup or in documentation (online or textual) provided with the package. Redistribution and use in source and binary forms, with or without modification, are permitted provided that the following conditions are met:

1. Redistributions of source code must retain the copyright notice, this list of conditions and the following disclaimer.
2. Redistributions in binary form must reproduce the above copyright notice, this list of conditions and the following disclaimer in the documentation and/or other materials provided with the distribution.
3. All advertising materials mentioning features or use of this software must display the following acknowledgment: "This product includes cryptographic software written by Eric Young ([ey@cryptsoft.com](mailto:ey@cryptsoft.com))" The word "cryptographic" can be left out if the routines from the library being used are not cryptographic related :-).
4. If you include any Windows specific code (or a derivative thereof) from the apps directory (application code) you must include an acknowledgment: "This product includes software written by Tim Hudson ([tjh@cryptsoft.com](mailto:tjh@cryptsoft.com))"

THIS SOFTWARE IS PROVIDED BY ERIC YOUNG "AS IS" AND ANY EXPRESS OR IMPLIED WARRANTIES, INCLUDING, BUT NOT LIMITED TO, THE IMPLIED WARRANTIES OF MERCHANTABILITY AND FITNESS FOR A PARTICULAR PURPOSE ARE DISCLAIMED. IN NO EVENT SHALL THE AUTHOR OR CONTRIBUTORS BE LIABLE FOR ANY DIRECT, INDIRECT, INCIDENTAL, SPECIAL, EXEMPLARY, OR CONSEQUENTIAL DAMAGES (INCLUDING, BUT NOT LIMITED TO, PROCUREMENT OF SUBSTITUTE GOODS OR SERVICES; LOSS OF USE, DATA, OR PROFITS; OR BUSINESS INTERRUPTION) HOWEVER CAUSED AND ON ANY THEORY OF LIABILITY, WHETHER IN CONTRACT, STRICT LIABILITY, OR TORT (INCLUDING NEGLIGENCE OR OTHERWISE) ARISING IN ANY WAY OUT OF THE USE OF THIS SOFTWARE, EVEN IF ADVISED OF THE POSSIBILITY OF SUCH DAMAGE.

The license and distribution terms for any publicly available version or derivative of this code cannot be changed. i.e. this code cannot simply be copied and put under another distribution licence [including the GNU Public Licence.]

## BSD License

Some software components of this product incorporate source code covered under the BSD license as follows.

Component Name	License	URL
net-snmp-5.7.3	BSD	<a href="http://www.net-snmp.org/about/license.html">http://www.net-snmp.org/about/license.html</a>
pcrc-8.38	BSD	
libcap-1.7.4	BSD 2.0	<a href="http://www.kernel.org/pub/linux/libs/security/linux-privs/libcap2">http://www.kernel.org/pub/linux/libs/security/linux-privs/libcap2</a>
lighttpd-1.4.35	BSD 2.0	<a href="http://www.opensource.org/licenses/bsd-license.html">http://www.opensource.org/licenses/bsd-license.html</a>
MiniUPnP Project Client	BSD 2.0	
pppd-2.4.7	BSD 2.0	<a href="http://opensource.org/licenses/BSD-3-Clause">http://opensource.org/licenses/BSD-3-Clause</a>

lighttpd is a secure, fast, compliant, and very flexible webserver that has been optimized for high-performance environments. It has a very low memory footprint compared to other web servers and takes care of cpuload. Its advanced feature-set (FastCGI, CGI, Auth, Output-Compression, URL-Rewriting and many more) make lighttpd the perfect webserver software for every server that suffers load problems. Simple Network Management Protocol (SNMP) is an Internetstandard protocol for managing devices on IP networks. It is used mostly in network management systems to monitor the devices attached to the network for conditions that need administrative attention. Net-SNMP is a suite of applications used to implement SNMP v1, SNMP v2c and SNMP v3 using both IPv4 and IPv6. For more additional information, send email to [help.cctv@hanwha.com](mailto:help.cctv@hanwha.com).

Copyright (C) 2004, Kneschke, incremental

All rights reserved.

Redistribution and use in source and binary forms, with or without modification, are permitted provided that the following conditions are met :

- Redistributions of source code must retain the above copyright notice, this list of conditions and the following disclaimer.
- Redistributions in binary form must reproduce the above copyright notice, this list of conditions and the following disclaimer in the documentation and/or other materials provided with the distribution.
- Neither the name of the "incremental" nor the names of its contributors may be used to endorse or promote products derived from this software without specific prior written permission.

THIS SOFTWARE IS PROVIDED BY THE COPYRIGHT HOLDERS AND CONTRIBUTORS "AS IS" AND ANY EXPRESS OR IMPLIED WARRANTIES, INCLUDING, BUT NOT LIMITED TO, THE IMPLIED WARRANTIES OF MERCHANTABILITY AND FITNESS FOR A PARTICULAR PURPOSE ARE DISCLAIMED. IN NO EVENT SHALL THE COPYRIGHT OWNER OR CONTRIBUTORS BE LIABLE FOR ANY DIRECT, INDIRECT, INCIDENTAL, SPECIAL, EXEMPLARY, OR CONSEQUENTIAL DAMAGES (INCLUDING, BUT NOT LIMITED TO, PROCUREMENT OF SUBSTITUTE GOODS OR SERVICES; LOSS OF USE, DATA, OR PROFITS; OR BUSINESS INTERRUPTION) HOWEVER CAUSED AND ON ANY THEORY OF LIABILITY, WHETHER IN CONTRACT, STRICT LIABILITY, OR TORT (INCLUDING NEGLIGENCE OR OTHERWISE) ARISING IN ANY WAY OUT OF THE USE OF THIS SOFTWARE, EVEN IF ADVISED OF THE POSSIBILITY OF SUCH DAMAGE.

Copyright (c) 1998-2001 University College London

All rights reserved.

Redistribution and use in source and binary forms, with or without modification, is permitted provided that the following conditions are met :

1. Redistributions of source code must retain the above copyright notice, this list of conditions and the following disclaimer.
2. Redistributions in binary form must reproduce the above copyright notice, this list of conditions and the following disclaimer in the documentation and/or other materials provided with the distribution.
3. All advertising materials mentioning features or use of this software must display the following acknowledgement: This product includes software developed by the Computer Science Department at University College London.
4. Neither the name of the University nor of the Department may be used to endorse or promote products derived from this software without specific prior written permission.

THIS SOFTWARE IS PROVIDED BY THE AUTHORS AND CONTRIBUTORS "AS IS" AND ANY EXPRESSED OR IMPLIED WARRANTIES, INCLUDING, BUT NOT LIMITED TO, THE IMPLIED WARRANTIES OF MERCHANTABILITY AND FITNESS FOR A PARTICULAR PURPOSE ARE DISCLAIMED. IN NO EVENT SHALL THE AUTHORS OR CONTRIBUTORS BE LIABLE FOR ANY DIRECT, INDIRECT, INCIDENTAL, SPECIAL, EXEMPLARY, OR CONSEQUENTIAL DAMAGES (INCLUDING, BUT NOT LIMITED TO, PROCUREMENT OF SUBSTITUTE GOODS OR SERVICES; LOSS OF USE, DATA, OR PROFITS; OR BUSINESS INTERRUPTION) HOWEVER CAUSED AND ON ANY THEORY OF LIABILITY, WHETHER IN CONTRACT, STRICT LIABILITY, OR TORT (INCLUDING NEGLIGENCE OR OTHERWISE) ARISING IN ANY WAY OUT OF THE USE OF THIS SOFTWARE, EVEN IF ADVISED OF THE POSSIBILITY OF SUCH DAMAGE.

Copyright (c) 1988, 1989, 1990, 1991, 1993, 1994, 1995, 1996 The Regents of the University of California.

All rights reserved.

Redistribution and use in source and binary forms, with or without modification, are permitted provided that the following conditions are met:

1. Redistributions of source code must retain the above copyright notice, this list of conditions and the following disclaimer.
2. Redistributions in binary form must reproduce the above copyright notice, this list of conditions and the following disclaimer in the documentation and/or other materials provided with the distribution.
3. Neither the name of the Regents of the University of California nor the names of its contributors may be used to endorse or promote products derived from this software without specific prior written permission.

THIS SOFTWARE IS PROVIDED BY THE COPYRIGHT HOLDERS AND CONTRIBUTORS "AS IS" AND ANY EXPRESS OR IMPLIED WARRANTIES, INCLUDING, BUT NOT LIMITED TO, THE IMPLIED WARRANTIES OF MERCHANTABILITY AND FITNESS FOR A PARTICULAR PURPOSE ARE DISCLAIMED. IN NO EVENT SHALL THE COPYRIGHT OWNER OR CONTRIBUTORS BE LIABLE FOR ANY DIRECT, INDIRECT, INCIDENTAL, SPECIAL, EXEMPLARY, OR CONSEQUENTIAL DAMAGES (INCLUDING, BUT NOT LIMITED TO, PROCUREMENT OF SUBSTITUTE GOODS OR SERVICES; LOSS OF USE, DATA, OR PROFITS; OR BUSINESS INTERRUPTION) HOWEVER CAUSED AND ON ANY THEORY OF LIABILITY, WHETHER IN CONTRACT, STRICT LIABILITY, OR TORT (INCLUDING NEGLIGENCE OR OTHERWISE) ARISING IN ANY WAY OUT OF THE USE OF THIS SOFTWARE, EVEN IF ADVISED OF THE POSSIBILITY OF SUCH DAMAGE.

Copyright (c) 2006, Creative Labs Inc

All rights reserved.

Redistribution and use in source and binary forms, with or without modification, are permitted provided that the following conditions are met:

1. Redistributions of source code must retain the above copyright notice, this list of conditions and the following disclaimer.
2. Redistributions in binary form must reproduce the above copyright notice, this list of conditions and the following disclaimer in the documentation and/or other materials provided with the distribution.
3. Neither the name of the Creative Labs nor the names of its contributors may be used to endorse or promote products derived from this software without specific prior written permission.

THIS SOFTWARE IS PROVIDED BY THE COPYRIGHT HOLDERS AND CONTRIBUTORS "AS IS" AND ANY EXPRESS OR IMPLIED WARRANTIES, INCLUDING, BUT NOT LIMITED TO, THE IMPLIED WARRANTIES OF MERCHANTABILITY AND FITNESS FOR A PARTICULAR PURPOSE ARE DISCLAIMED. IN NO EVENT SHALL THE COPYRIGHT OWNER OR CONTRIBUTORS BE LIABLE FOR ANY DIRECT, INDIRECT, INCIDENTAL, SPECIAL, EXEMPLARY, OR CONSEQUENTIAL DAMAGES (INCLUDING, BUT NOT LIMITED TO, PROCUREMENT OF SUBSTITUTE GOODS OR SERVICES; LOSS OF USE, DATA, OR PROFITS; OR BUSINESS INTERRUPTION) HOWEVER CAUSED AND ON ANY THEORY OF LIABILITY, WHETHER IN CONTRACT, STRICT LIABILITY, OR TORT (INCLUDING NEGLIGENCE OR OTHERWISE) ARISING IN ANY WAY OUT OF THE USE OF THIS SOFTWARE, EVEN IF ADVISED OF THE POSSIBILITY OF SUCH DAMAGE.

Copyright (c) 2005-2012, Thomas BERNARD

All rights reserved.

Redistribution and use in source and binary forms, with or without modification, are permitted provided that the following conditions are met:

1. Redistributions of source code must retain the above copyright notice, this list of conditions and the following disclaimer.
2. Redistributions in binary form must reproduce the above copyright notice, this list of conditions and the following disclaimer in the documentation and/or other materials provided with the distribution.
3. Neither the name of Thomas BERNARD nor the names of its contributors may be used to endorse or promote products derived from this software without specific prior written permission.

THIS SOFTWARE IS PROVIDED BY THE COPYRIGHT HOLDERS AND CONTRIBUTORS "AS IS" AND ANY EXPRESS OR IMPLIED WARRANTIES, INCLUDING, BUT NOT LIMITED TO, THE IMPLIED WARRANTIES OF MERCHANTABILITY AND FITNESS FOR A PARTICULAR PURPOSE ARE DISCLAIMED. IN NO EVENT SHALL THE COPYRIGHT OWNER OR CONTRIBUTORS BE LIABLE FOR ANY DIRECT, INDIRECT, INCIDENTAL, SPECIAL, EXEMPLARY, OR CONSEQUENTIAL DAMAGES (INCLUDING, BUT NOT LIMITED TO, PROCUREMENT OF SUBSTITUTE GOODS OR SERVICES; LOSS OF USE, DATA, OR PROFITS; OR BUSINESS INTERRUPTION) HOWEVER CAUSED AND ON ANY THEORY OF LIABILITY, WHETHER IN CONTRACT, STRICT LIABILITY, OR

TORT (INCLUDING NEGLIGENCE OR OTHERWISE) ARISING IN ANY WAY OUT OF THE USE OF THIS SOFTWARE, EVEN IF ADVISED OF THE POSSIBILITY OF SUCH DAMAGE.

Various copyrights apply to this package, listed in various separate parts below. Please make sure that you read all the parts.

#### **Part 1 : CMU/UCD copyright notice: (BSD like)**

Copyright 1989, 1991, 1992 by Carnegie Mellon University Derivative Work - 1996, 1998-2000

Copyright 1996, 1998-2000 The Regents of the University of California

All Rights Reserved

Permission to use, copy, modify and distribute this software and its documentation for any purpose and without fee is hereby granted, provided that the above copyright notice appears in all copies and that both that copyright notice and this permission notice appear in supporting documentation, and that the name of CMU and The Regents of the University of California not be used in advertising or publicity pertaining to distribution of the software without specific written permission.

CMU AND THE REGENTS OF THE UNIVERSITY OF CALIFORNIA DISCLAIM ALL WARRANTIES WITH REGARD TO THIS SOFTWARE, INCLUDING ALL IMPLIED WARRANTIES OF MERCHANTABILITY AND FITNESS. IN NO EVENT SHALL CMU OR THE REGENTS OF THE UNIVERSITY OF CALIFORNIA BE LIABLE FOR ANY SPECIAL, INDIRECT OR CONSEQUENTIAL DAMAGES OR ANY DAMAGES WHATSOEVER RESULTING FROM THE LOSS OF USE, DATA OR PROFITS, WHETHER IN AN ACTION OF CONTRACT, NEGLIGENCE OR OTHER TORTIOUS ACTION, ARISING OUT OF OR IN CONNECTION WITH THE USE OR PERFORMANCE OF THIS SOFTWARE.

#### **Part 2 : Networks Associates Technology, Inc copyright notice (BSD)**

Copyright (c) 2001-2003, Networks Associates Technology, Inc

All rights reserved.

Redistribution and use in source and binary forms, with or without modification, are permitted provided that the following conditions are met: yy Redistributions of source code must retain the above copyright notice, this list of conditions and the following disclaimer. yy Redistributions in binary form must reproduce the above copyright notice, this list of conditions and the following disclaimer in the documentation and/or other materials provided with the distribution. yy Neither the name of the Networks Associates Technology, Inc nor the names of its contributors may be used to endorse or promote products derived from this software without specific prior written permission.

THIS SOFTWARE IS PROVIDED BY THE COPYRIGHT HOLDERS AND CONTRIBUTORS "AS IS" AND ANY EXPRESS OR IMPLIED WARRANTIES, INCLUDING, BUT NOT LIMITED TO, THE IMPLIED WARRANTIES OF MERCHANTABILITY AND FITNESS FOR A PARTICULAR PURPOSE ARE DISCLAIMED. IN NO EVENT SHALL THE COPYRIGHT HOLDERS OR CONTRIBUTORS BE LIABLE FOR ANY DIRECT, INDIRECT, INCIDENTAL, SPECIAL, EXEMPLARY, OR CONSEQUENTIAL DAMAGES (INCLUDING, BUT NOT LIMITED TO, PROCUREMENT OF SUBSTITUTE GOODS OR SERVICES; LOSS OF USE, DATA, OR PROFITS; OR BUSINESS INTERRUPTION) HOWEVER CAUSED AND ON ANY THEORY OF LIABILITY, WHETHER IN CONTRACT, STRICT LIABILITY, OR TORT (INCLUDING NEGLIGENCE OR OTHERWISE) ARISING IN ANY WAY OUT OF THE USE OF THIS SOFTWARE, EVEN IF ADVISED OF THE POSSIBILITY OF SUCH DAMAGE.

#### **Part 3 : Cambridge Broadband Ltd. copyrightnotice (BSD)**

Portions of this code are copyright (c) 2001-2003, Cambridge Broadband Ltd.

All rights reserved.

Redistribution and use in source and binary forms, with or without modification, are permitted provided that the following conditions are met: yy Redistributions of source code must retain the above copyright notice, this list of conditions and the following disclaimer. yy Redistributions in binary form must reproduce the above copyright notice, this list of conditions and the following disclaimer in the documentation and/or other materials provided with the distribution. yy The name of Cambridge Broadband Ltd. may not be used to endorse or promote products derived from this software without specific prior written permission.

THIS SOFTWARE IS PROVIDED BY THE COPYRIGHT HOLDER "AS IS" AND ANY EXPRESS OR IMPLIED WARRANTIES, INCLUDING, BUT NOT LIMITED TO, THE IMPLIED WARRANTIES OF MERCHANTABILITY AND FITNESS FOR A PARTICULAR PURPOSE ARE DISCLAIMED. IN NO EVENT SHALL THE COPYRIGHT HOLDER BE LIABLE FOR ANY DIRECT, INDIRECT, INCIDENTAL, SPECIAL, EXEMPLARY, OR CONSEQUENTIAL DAMAGES (INCLUDING, BUT NOT LIMITED TO, PROCUREMENT OF SUBSTITUTE GOODS OR SERVICES; LOSS OF USE, DATA, OR PROFITS; OR BUSINESS INTERRUPTION) HOWEVER CAUSED AND ON ANY THEORY OF LIABILITY, WHETHER IN CONTRACT, STRICT LIABILITY, OR TORT (INCLUDING NEGLIGENCE OR OTHERWISE) ARISING IN ANY WAY OUT OF THE USE OF THIS SOFTWARE, EVEN IF ADVISED OF THE POSSIBILITY OF SUCH DAMAGE.

#### **Part 4 : Sun Microsystems, Inc. copyright notice**

(BSD)

Copyright (c) 2003 Sun Microsystems, Inc., 4150 Network

Circle, Santa Clara, California 95054, U.S.A.

All rights reserved.

Use is subject to license terms below. This distribution may include materials developed by third parties. Sun, Sun Microsystems, the Sun logo and Solaris are trademarks or registered trademarks of Sun Microsystems, Inc. in the U.S. and other countries. Redistribution and use in source and binary forms, with or without modification, are permitted provided that the following conditions are met: yy Redistributions of source code must retain the above copyright notice, this list of conditions and the following disclaimer. yy Redistributions in binary form must reproduce the above copyright notice, this list of conditions and the following disclaimer in the documentation and/or other materials provided with the distribution. yy Neither the name of the Sun Microsystems, Inc. nor the names of its contributors may be used to endorse or promote products derived from this software without specific prior written permission.

THIS SOFTWARE IS PROVIDED BY THE COPYRIGHT HOLDERS AND CONTRIBUTORS "AS IS" AND ANY EXPRESS OR IMPLIED WARRANTIES, INCLUDING, BUT NOT LIMITED TO, THE IMPLIED WARRANTIES OF MERCHANTABILITY AND FITNESS FOR A PARTICULAR PURPOSE ARE DISCLAIMED. IN NO EVENT SHALL THE COPYRIGHT HOLDERS OR CONTRIBUTORS BE LIABLE FOR ANY DIRECT, INDIRECT, INCIDENTAL, SPECIAL, EXEMPLARY, OR CONSEQUENTIAL DAMAGES (INCLUDING, BUT NOT LIMITED TO, PROCUREMENT OF SUBSTITUTE GOODS OR SERVICES; LOSS OF USE, DATA, OR PROFITS; OR BUSINESS INTERRUPTION) HOWEVER CAUSED AND ON ANY THEORY OF LIABILITY, WHETHER IN CONTRACT, STRICT LIABILITY, OR TORT (INCLUDING NEGLIGENCE OR OTHERWISE) ARISING IN ANY WAY OUT OF THE USE OF THIS SOFTWARE, EVEN IF ADVISED OF THE POSSIBILITY OF SUCH DAMAGE.

#### **Part 5 : Sparta, Inc copyright notice (BSD)**

Copyright (c) 2003-2009, Sparta, Inc

All rights reserved.

Redistribution and use in source and binary forms, with or without modification, are permitted provided that the following conditions are met: yy Redistributions of source code must retain the above copyright notice, this list of conditions and the following disclaimer. yy Redistributions in binary form must reproduce the

above copyright notice, this list of conditions and the following disclaimer in the documentation and/or other materials provided with the distribution. yy Neither the name of Sparta, Inc nor the names of its contributors may be used to endorse or promote products derived from this software without specific prior written permission.

THIS SOFTWARE IS PROVIDED BY THE COPYRIGHT HOLDERS AND CONTRIBUTORS "AS IS" AND ANY EXPRESS OR IMPLIED WARRANTIES, INCLUDING, BUT NOT LIMITED TO, THE IMPLIED WARRANTIES OF MERCHANTABILITY AND FITNESS FOR A PARTICULAR PURPOSE ARE DISCLAIMED. IN NO EVENT SHALL THE COPYRIGHT HOLDERS OR CONTRIBUTORS BE LIABLE FOR ANY DIRECT, INDIRECT, INCIDENTAL, SPECIAL, EXEMPLARY, OR CONSEQUENTIAL DAMAGES (INCLUDING, BUT NOT LIMITED TO, PROCUREMENT OF SUBSTITUTE GOODS OR SERVICES; LOSS OF USE, DATA, OR PROFITS; OR BUSINESS INTERRUPTION) HOWEVER CAUSED AND ON ANY THEORY OF LIABILITY, WHETHER IN CONTRACT, STRICT LIABILITY, OR TORT (INCLUDING NEGLIGENCE OR OTHERWISE) ARISING IN ANY WAY OUT OF THE USE OF THIS SOFTWARE, EVEN IF ADVISED OF THE POSSIBILITY OF SUCH DAMAGE.

#### Part 6: Cisco/BUPTNIC copyright notice (BSD)

Copyright (c) 2004, Cisco, Inc and Information Network

Center of Beijing University of Posts and Telecommunications.

All rights reserved.

Redistribution and use in source and binary forms, with or without modification, are permitted provided that the following conditions are met: yy Redistributions of source code must retain the above copyright notice, this list of conditions and the following disclaimer. yy Redistributions in binary form must reproduce the above copyright notice, this list of conditions and the following disclaimer in the documentation and/or other materials provided with the distribution. yy Neither the name of Cisco, Inc, Beijing University of Posts and Telecommunications, nor the names of their contributors may be used to endorse or promote products derived from this software without specific prior written permission.

THIS SOFTWARE IS PROVIDED BY THE COPYRIGHT HOLDERS AND CONTRIBUTORS "AS IS" AND ANY EXPRESS OR IMPLIED WARRANTIES, INCLUDING, BUT NOT LIMITED TO, THE IMPLIED WARRANTIES OF MERCHANTABILITY AND FITNESS FOR A PARTICULAR PURPOSE ARE DISCLAIMED. IN NO EVENT SHALL THE COPYRIGHT HOLDERS OR CONTRIBUTORS BE LIABLE FOR ANY DIRECT, INDIRECT, INCIDENTAL, SPECIAL, EXEMPLARY, OR CONSEQUENTIAL DAMAGES (INCLUDING, BUT NOT LIMITED TO, PROCUREMENT OF SUBSTITUTE GOODS OR SERVICES; LOSS OF USE, DATA, OR PROFITS; OR BUSINESS INTERRUPTION) HOWEVER CAUSED AND ON ANY THEORY OF LIABILITY, WHETHER IN CONTRACT, STRICT LIABILITY, OR TORT (INCLUDING NEGLIGENCE OR OTHERWISE) ARISING IN ANY WAY OUT OF THE USE OF THIS SOFTWARE, EVEN IF ADVISED OF THE POSSIBILITY OF SUCH DAMAGE.

#### Part 7: Fabasoft R&D Software Software GmbH & Co KG copyright Notice (BSD)

Copyright (c) Fabasoft R&D Software GmbH & Co KG, 2003oss@fabasoft.com

Author: Bernhard Penz

Redistribution and use in source and binary forms, with or without modification, are permitted provided that the following conditions are met: yy Redistributions of source code must retain the above copyright notice, this list of conditions and the following disclaimer. yy Redistributions in binary form must reproduce the above copyright notice, this list of conditions and the following disclaimer in the documentation and/or other materials provided with the distribution. yy The name of Fabasoft R&D Software GmbH & Co KG or any of its subsidiaries, brand or product names may not be used to endorse or promote products derived from this software without specific prior written permission.

THIS SOFTWARE IS PROVIDED BY THE COPYRIGHT HOLDER "AS IS" AND ANY EXPRESS OR IMPLIED WARRANTIES, INCLUDING, BUT NOT LIMITED TO, THE IMPLIED WARRANTIES OF MERCHANTABILITY AND FITNESS FOR A PARTICULAR PURPOSE ARE DISCLAIMED. IN NO EVENT SHALL THE COPYRIGHT HOLDER BE LIABLE FOR ANY DIRECT, INDIRECT, INCIDENTAL, SPECIAL, EXEMPLARY, OR CONSEQUENTIAL DAMAGES (INCLUDING, BUT NOT LIMITED TO, PROCUREMENT OF SUBSTITUTE GOODS OR SERVICES; LOSS OF USE, DATA, OR PROFITS; OR BUSINESS INTERRUPTION) HOWEVER CAUSED AND ON ANY THEORY OF LIABILITY, WHETHER IN CONTRACT, STRICT LIABILITY, OR TORT (INCLUDING NEGLIGENCE OR OTHERWISE) ARISING IN ANY WAY OUT OF THE USE OF THIS SOFTWARE, EVEN IF ADVISED OF THE POSSIBILITY OF SUCH DAMAGE.

#### Part 8: Apple Inc. copyright notice (BSD)

Copyright (c) 2007 Apple Inc.

All rights reserved.

Redistribution and use in source and binary forms, with or without modification, are permitted provided that the following conditions are met:

1. Redistributions of source code must retain the above copyright notice, this list of conditions and the following disclaimer.
2. Redistributions in binary form must reproduce the above copyright notice, this list of conditions and the following disclaimer in the documentation and/or other materials provided with the distribution. 3. Neither the name of Apple Inc. ("Apple") nor the names of its contributors may be used to endorse or promote products derived from this software without specific prior written permission.

THIS SOFTWARE IS PROVIDED BY APPLE AND ITS CONTRIBUTORS "AS IS" AND ANY EXPRESS OR IMPLIED WARRANTIES, INCLUDING, BUT NOT LIMITED TO, THE IMPLIED WARRANTIES OF MERCHANTABILITY AND FITNESS FOR A PARTICULAR PURPOSE ARE DISCLAIMED. IN NO EVENT SHALL APPLE OR ITS CONTRIBUTORS BE LIABLE FOR ANY DIRECT, INDIRECT, INCIDENTAL, SPECIAL, EXEMPLARY, OR CONSEQUENTIAL DAMAGES (INCLUDING, BUT NOT LIMITED TO, PROCUREMENT OF SUBSTITUTE GOODS OR SERVICES; LOSS OF USE, DATA, OR PROFITS; OR BUSINESS INTERRUPTION) HOWEVER CAUSED AND ON ANY THEORY OF LIABILITY, WHETHER IN CONTRACT, STRICT LIABILITY, OR TORT (INCLUDING NEGLIGENCE OR OTHERWISE) ARISING IN ANY WAY OUT OF THE USE OF THIS SOFTWARE, EVEN IF ADVISED OF THE POSSIBILITY OF SUCH DAMAGE.

#### Part 9: ScienceLogic, LLC copyright notice(BSD)

Copyright (c) 2009, ScienceLogic, LLC

All rights reserved.

Redistribution and use in source and binary forms, with or without modification, are permitted provided that the following conditions aremet: yy Redistributions of source code must retain the above copyright notice, this list of conditions and the following disclaimer. yy Redistributions in binary form must reproduce the above copyright notice, this list of conditions and the following disclaimer in the documentation and/or other materials provided with the distribution. yy Neither the name of ScienceLogic, LLC nor the names of its contributors may be used to endorse or promote products derived from this software without specific prior written permission.

THIS SOFTWARE IS PROVIDED BY THE COPYRIGHT HOLDERS AND CONTRIBUTORS "AS IS" AND ANY EXPRESS OR IMPLIED WARRANTIES, INCLUDING, BUT NOT LIMITED TO, THE IMPLIED WARRANTIES OF MERCHANTABILITY AND FITNESS FOR A PARTICULAR PURPOSE ARE DISCLAIMED. IN NO EVENT SHALL THE COPYRIGHT HOLDERS OR CONTRIBUTORS BE LIABLE FOR ANY DIRECT, INDIRECT, INCIDENTAL, SPECIAL, EXEMPLARY, OR CONSEQUENTIAL DAMAGES (INCLUDING, BUT NOT LIMITED TO, PROCUREMENT OF SUBSTITUTE GOODS OR SERVICES; LOSS OF USE, DATA, OR PROFITS; OR BUSINESS INTERRUPTION) HOWEVER CAUSED AND ON ANY THEORY OF LIABILITY, WHETHER IN CONTRACT, STRICT LIABILITY, OR TORT (INCLUDING NEGLIGENCE OR OTHERWISE) ARISING IN ANY WAY OUT OF THE USE OF THIS SOFTWARE, EVEN IF ADVISED OF THE POSSIBILITY OF SUCH DAMAGE

## The MIT License

Some software components of this product incorporate source code covered under the MIT license as follows

### MIT License 2.0

- Acedwidet, bettermeans, jquery-ui, libxml, libxml2, Mesa3D-MesaLib,mwEmbed,OpenGL Samples Pack, Wide Studio, xorg-server, dropbear-2012.55, ncurses-5.7

Copyright (c) 2011, The Dojo Foundation

Copyright 2010, AUTHORS.txt (<http://jqueryui.com/about>)

Dual licensed under the MIT or GPL Version 2 licenses.

- <http://jquery.org/license>

- <http://docs.jquery.com/UI/Widget>

Copyright Daniel Veillard

Copyright Igor Zlatovic <[igor@zlatovic.com](mailto:igor@zlatovic.com)>

Copyright Aleksey Sanin

Copyright Gary Pennington <[Gary.Pennington@uk.sun.com](mailto:Gary.Pennington@uk.sun.com)>

Copyright Alfred Mickautsch <[alfred@mickautsch.de](mailto:alfred@mickautsch.de)>

Copyright Bjorn Reese <[bjorn.reese@systematic.dk](mailto:bjorn.reese@systematic.dk)>

Copyright Joel W. Reed

Copyright William Brack <[wbrack@mmm.com.hk](mailto:wbrack@mmm.com.hk)>

Copyright (c) 2007-2010 The Khronos Group Inc.

Copyright Atish Kumar Patra

Copyright (c) 2006 Free Software Foundation, Inc.

Permission is hereby granted, free of charge, to any person obtaining a copy of this software and associated documentation files (the "Software"), to deal in the Software without restriction, including without limitation the rights to use, copy, modify, merge, publish, distribute, sublicense, and/or sell copies of the Software, and to permit persons to whom the Software is furnished to do so, subject to the following conditions:

The above copyright notice and this permission notice shall be included in all copies or substantial portions of the Software.

THE SOFTWARE IS PROVIDED "AS IS", WITHOUT WARRANTY OF ANY KIND, EXPRESS OR IMPLIED, INCLUDING BUT NOT LIMITED TO THE WARRANTIES OF MERCHANTABILITY, FITNESS FOR A PARTICULAR PURPOSE AND NONINFRINGEMENT. IN NO EVENT SHALL THE AUTHORS OR COPYRIGHT HOLDERS BE LIABLE FOR ANY CLAIM, DAMAGES OR OTHER LIABILITY, WHETHER IN AN ACTION OF CONTRACT, TORT OR OTHERWISE, ARISING FROM, OUT OF OR IN CONNECTION WITH THE SOFTWARE OR THE USE OR OTHER DEALINGS IN THE SOFTWARE.

## Mozilla Public License

Since we, at Hanwha Techwin, used the Mozilla Firefox component without modifying the source code according to the MOZILLA Public license 1.1, we are not obliged to provide the source code of the corresponding component.

- Version 1.1

### 1. Definitions.

1.0.1. "Commercial Use" means distribution or otherwise making the Covered Code available to a third party.

1.1. "Contributor" means each entity that creates or contributes to the creation of Modifications.

1.2. "Covered Code" means the combination of the Original Code, prior Modifications used by a Contributor, and the Modifications made by that particular Contributor.

1.3. "Derived Code" means the Original Code or Modifications or the combination of the Original Code and Modifications, in each case including portions thereof.

1.4. "Electronic Distribution Mechanism" means a mechanism generally accepted in the software development community for the electronic transfer of data.

1.5. "Executable" means Covered Code in any form other than Source Code.

1.6. "Initial Developer" means the individual or entity identified as the Initial Developer in the Source Code notice required by Exhibit A.

1.7. "Larger Work" means a work which combines Covered Code or portions thereof with code not governed by the terms of this License.

1.8. "License" means this document.

1.8.1. "Licensable" means having the right to grant, to the maximum extent possible, whether at the time of the initial grant or subsequently acquired, any and all of the rights conveyed herein.

1.9. "Modifications" means any addition to or deletion from the substance or structure of either the Original Code or any previous Modifications. When Covered Code is released as a series of files, a Modification is:

A. Any addition to or deletion from the contents of a file containing Original Code or previous Modifications.

B. Any new file that contains any part of the Original Code or previous Modifications.

1.10. "Original Code" means Source Code of computer software code which is described in the Source Code notice required by Exhibit A as Original Code, and which, at the time of its release under this License is not already Covered Code governed by this License.

1.10.1. "Patent Claims" means any patent claim(s), now owned or hereafter acquired, including without limitation, method, process, and apparatus claims, in any patent Licensable by grantor.

**1.11.** "Source Code" means the preferred form of the Covered Code for making modifications to it, including all modules it contains, plus any associated interface definition files, scripts used to control compilation and installation of an Executable, or source code differential comparisons against either the Original Code or another well known, available Covered Code of the Contributor's choice. The Source Code can be in a compressed or archival form, provided the appropriate decompression or de-archiving software is widely available for no charge.

**1.12.** "You" (or "Your") means an individual or a legal entity exercising rights under, and complying with all of the terms of, this License or a future version of this License issued under Section 6.1. For legal entities, "You" includes any entity which controls, is controlled by, or is under common control with You. For purposes of this definition, "control" means (a) the power, direct or indirect, to cause the direction or management of such entity, whether by contract or otherwise, or (b) ownership of more than fifty percent (50%) of the outstanding shares or beneficial ownership of such entity.

## 2. Source Code License.

**2.1.** The Initial Developer Grant. The Initial Developer hereby grants You a world-wide, royalty-free, non-exclusive license, subject to third party intellectual property claims:

- (a) under intellectual property rights (other than patent or trademark) licensable by Initial Developer to use, reproduce, modify, display, perform, sublicense and distribute the Original Code (or portions thereof) with or without Modifications, and/or as part of a Larger Work; and
- (b) under Patents Claims infringed by the making, using or selling of Original Code, to make, have made, use, practice, sell, and offer for sale, and/or otherwise dispose of the Original Code (or portions thereof).
- (c) the licenses granted in this Section 2.1(a) and (b) are effective on the date Initial Developer first distributes Original Code under the terms of this License.
- (d) Notwithstanding Section 2.1(b) above, no patent license is granted: 1) for that code that You delete from the Original Code; 2) separate from the Original Code; or 3) for infringements caused by: i) the modification of the Original Code or ii) the combination of the Original Code with other software or devices.

**2.2.** Contributor Grant. Subject to third party intellectual property claims, each Contributor hereby grants You a world-wide, royalty-free, non-exclusive license

- (a) under intellectual property rights (other than patent or trademark) licensable by Contributor, to use, reproduce, modify, display, perform, sublicense and distribute the Modifications created by such Contributor (or portions thereof) either on an unmodified basis, with other Modifications, as Covered Code and/or as part of a Larger Work; and
- (b) under Patent Claims infringed by the making, using, or selling of Modifications made by that Contributor either alone and/or in combination with its Contributor Version (or portions of such combination), to make, use, sell, offer for sale, have made, and/or otherwise dispose of: 1) Modifications made by that Contributor (or portions thereof); and 2) the combination of Modifications made by that Contributor with its Contributor Version (or portions of such combination).
- (c) the licenses granted in Sections 2.2(a) and 2.2(b) are effective on the date Contributor first makes Commercial Use of the Covered Code.
- (d) Notwithstanding Section 2.2(b) above, no patent license is granted: 1) for any code that Contributor has deleted from the Contributor Version; 2) separate from the Contributor Version; 3) for infringements caused by: i) third party modifications of Contributor Version or ii) the combination of Modifications made by that Contributor with other software (except as part of the Contributor Version) or other devices; or 4) under Patent Claims infringed by Covered Code in the absence of Modifications made by that Contributor.

## 3. Distribution Obligations.

**3.1.** Application of License. The Modifications which you create or to which you contribute are governed by the terms of this License, including without limitation Section 2.2. The Source Code version of Covered Code may be distributed only under the terms of this License or a future version of this License released under Section 6.1, and You must include a copy of this License with every copy of the Source Code you distribute. You may not offer or impose any terms on any Source Code version that alters or restricts the applicable version of this License or the recipients' rights hereunder. However, You may include an additional document offering the additional rights described in Section 3.5.

**3.2.** Availability of Source Code. Any Modification which You create or to which You contribute must be made available in Source Code form under the terms of this License either on the same media as an Executable version or via an accepted Electronic Distribution Mechanism to anyone to whom you made an Executable version available; and if made available via Electronic Distribution Mechanism, must remain available for at least twelve (12) months after the date it initially became available, or at least six (6) months after a subsequent version of that particular Modification has been made available to such recipients. You are responsible for ensuring that the Source Code version remains available even if the Electronic Distribution Mechanism is maintained by a third party.

**3.3.** Description of Modifications. You must cause all Covered Code to which You contribute to contain a file documenting the changes You made to create that Covered Code and the date of any change. You must include a prominent statement that the Modification is derived, directly or indirectly, from Original Code provided by the Initial Developer and including the name of the Initial Developer in (a) the Source Code, and (b) in any notice in an Executable version or related documentation in which You describe the origin or ownership of the Covered Code.

## 3.4. Intellectual Property Matters

- (a) Third Party Claims. If Contributor has knowledge that a license under a third party's intellectual property rights is required to exercise the rights granted by such Contributor under Sections 2.1 or 2.2, Contributor must include a text file with the Source Code distribution titled "LEGAL" which describes the claim and the party making the claim in sufficient detail that a recipient will know whom to contact. If Contributor obtains such knowledge after the Modification is made available as described in Section 3.2, Contributor shall promptly modify the LEGAL file in all copies Contributor makes available thereafter and shall take other steps (such as notifying appropriate mailing lists or newsgroups) reasonably calculated to inform those who received the Covered Code that new knowledge has been obtained.
- (b) Contributor APIs. If Contributor's Modifications include an application programming interface and Contributor has knowledge of patent licenses which are reasonably necessary to implement that API, Contributor must also include this information in the LEGAL file.
- (c) Representations.

Contributor represents that, except as disclosed pursuant to Section 3.4(a) above, Contributor believes that Contributor's Modifications are Contributor's original creation(s) and/or Contributor has sufficient rights to grant the rights conveyed by this License.

**3.5.** Required Notices. You must duplicate the notice in Exhibit A in each file of the Source Code. If it is not possible to put such notice in a particular Source Code file due to its structure, then You must include such notice in a location (such as a relevant directory) where a user would be likely to look for such a notice. If You created one or more Modifications(s) You may add your name as a Contributor to the notice described in Exhibit A. You must also duplicate this License in any documentation for the Source Code where You describe recipients' rights or ownership rights relating to Covered Code. You may choose to offer, and to charge a fee for, warranty, support, indemnity or liability obligations to one or more recipients of Covered Code. However, You may do so only on Your own behalf, and not on behalf of the Initial Developer or any Contributor. You must make it absolutely clear that any such warranty, support, indemnity or liability obligation is offered by You alone, and You hereby agree to indemnify the Initial Developer and every Contributor for any liability incurred by the Initial Developer or such Contributor as a result of warranty, support, indemnity or liability terms You offer.

**3.6.** Distribution of Executable Versions. You may distribute Covered Code in Executable form only if the requirements of Section 3.1-3.5 have been met for that Covered Code, and if You include a notice stating that the Source Code version of the Covered Code is available under the terms of this License, including a description of how and where You have fulfilled the obligations of Section 3.2. The notice must be conspicuously included in any notice in an Executable version, related documentation or collateral in which You describe recipients' rights relating to the Covered Code. You may distribute the Executable version of Covered Code or ownership rights under a license of Your choice, which may contain terms different from this License, provided that You are in compliance with the terms of this License and that the license

for the Executable version does not attempt to limit or alter the recipient's rights in the Source Code version from the rights set forth in this License. If You distribute the Executable version under a different license You must make it absolutely clear that any terms which differ from this License are offered by You alone, not by the Initial Developer or any Contributor. You hereby agree to indemnify the Initial Developer and every Contributor for any liability incurred by the Initial Developer or such Contributor as a result of any such terms You offer.

**3.7.** Larger Works. You may create a Larger Work by combining Covered Code with other code not governed by the terms of this License and distribute the Larger Work as a single product. In such a case, You must make sure the requirements of this License are fulfilled for the Covered Code.

## 4. Inability to Comply Due to Statute or Regulation.

If it is impossible for You to comply with any of the terms of this License with respect to some or all of the Covered Code due to statute, judicial order, or regulation then You must: (a) comply with the terms of this License to the maximum extent possible; and (b) describe the limitations and the code they affect. Such description must be included in the LEGAL file described in Section 3.4 and must be included with all distributions of the Source Code. Except to the extent prohibited by statute or regulation, such description must be sufficiently detailed for a recipient of ordinary skill to be able to understand it.

## 5. Application of this License.

This License applies to code to which the Initial Developer has attached the notice in Exhibit A and to related Covered Code.

## 6. Versions of the License.

**6.1.** New Versions. Netscape Communications Corporation ("Netscape") may publish revised and/or new versions of the License from time to time. Each version will be given a distinguishing version number.

**6.2.** Effect of New Versions. Once Covered Code has been published under a particular version of the License, You may always continue to use it under the terms of that version. You may also choose to use such Covered Code under the terms of any subsequent version of the License published by Netscape. No one other than Netscape has the right to modify the terms applicable to Covered Code created under this License.

**6.3.** Derivative Works. If You create or use a modified version of this License (which you may only do in order to apply it to code which is not already Covered Code governed by this License), You must (a) rename your license so that the phrases "Mozilla", "MOZILLAPL", "MOZPL", "Netscape", "MPL", "NPL" or any confusingly similar phrase do not appear in your license (except to note that your license differs from this License) and (b) otherwise make it clear that Your version of the license contains terms which differ from the Mozilla Public License and Netscape Public License. (Filing in the name of the Initial Developer, Original Code or Contributor in the notices described in Exhibit A shall not of themselves be deemed to be modifications of this License.)

## 7. DISCLAIMER OF WARRANTY.

COVERED CODE IS PROVIDED UNDER THIS LICENSE ON AN "AS IS" BASIS, WITHOUT WARRANTY OF ANY KIND, EITHER EXPRESSED OR IMPLIED, INCLUDING, WITHOUT LIMITATION, WARRANTIES THAT THE COVERED CODE IS FREE OF DEFECTS, MERCHANTABILITY, FIT FOR A PARTICULAR PURPOSE OR NON-INFRINGEMENT. THE ENTIRE RISK AS TO THE QUALITY AND PERFORMANCE OF THE COVERED CODE IS WITH YOU. SHOULD ANY COVERED CODE PROVE DEFECTIVE IN ANY RESPECT, YOU (NOT THE INITIAL DEVELOPER OR ANY OTHER CONTRIBUTOR) ASSUME THE COST OF ANY NECESSARY SERVICING, REPAIR OR CORRECTION. THIS DISCLAIMER OF WARRANTY CONSTITUTES AN ESSENTIAL PART OF THIS LICENSE. NO USE OF ANY COVERED CODE IS AUTHORIZED HEREUNDER EXCEPT UNDER THIS DISCLAIMER.

## 8. TERMINATION.

**8.1.** This License and the rights granted hereunder will terminate automatically if You fail to comply with terms herein and fail to cure such breach within 30 days of becoming aware of the breach. All sublicenses to the Covered Code which are properly granted shall survive any termination of this License. Provisions which, by their nature, must remain in effect beyond the termination of this License shall survive.

**8.2.** If You initiate litigation by asserting a patent infringement claim (excluding declaratory judgment actions) against Initial Developer or a Contributor (the Initial Developer or Contributor against whom You file such action is referred to as "Participant") alleging that:

- (a) such Participant's Contributor Version directly or indirectly infringes any patent, then any and all rights granted by such Participant to You under Sections 2.1 and/or 2.2 of this License shall, upon 60 days notice from Participant terminate prospectively, unless if within 60 days after receipt of notice You either: (i) agree in writing to pay Participant a mutually agreeable reasonable royalty for Your past and future use of Modifications made by such Participant, or (ii) withdraw Your litigation claim with respect to the Contributor Version against such Participant. If within 60 days of notice, a reasonable royalty and payment arrangement are not mutually agreed upon in writing by the parties or the litigation claim is not withdrawn, the rights granted by Participant to You under Sections 2.1 and/or 2.2 automatically terminate at the expiration of the 60 day notice period specified above.

- (b) any software, hardware, or device, other than such Participant's Contributor Version, directly or indirectly infringes any patent, then any rights granted to You by such Participant under Sections 2.1(b) and 2.2(b) are revoked effective as of the date You first made, used, sold, distributed, or had made, Modifications made by that Participant.

**8.3.** If You assert a patent infringement claim against Participant alleging that such Participant's Contributor Version directly or indirectly infringes any patent where such claim is resolved (such as by license or settlement) prior to the initiation of patent infringement litigation, then the reasonable value of the licenses granted by such Participant under Sections 2.1 or 2.2 shall be taken into account in determining the amount or value of any payment or license.

**8.4.** In the event of termination under Sections 8.1 or 8.2 above, all end user license agreements (excluding distributors and resellers) which have been validly granted by You or any distributor hereunder prior to termination shall survive termination.

## 9. LIMITATION OF LIABILITY.

UNDER NO CIRCUMSTANCES AND UNDER NO LEGAL THEORY, WHETHER TORT (INCLUDING NEGLIGENCE), CONTRACT, OR OTHERWISE, SHALL YOU, THE INITIAL DEVELOPER, ANY OTHER CONTRIBUTOR, OR ANY DISTRIBUTOR OF COVERED CODE, OR ANY SUPPLIER OF ANY OF SUCH PARTIES, BE LIABLE TO ANY PERSON FOR ANY INDIRECT, SPECIAL, INCIDENTAL, OR CONSEQUENTIAL DAMAGES OF ANY CHARACTER INCLUDING, WITHOUT LIMITATION, DAMAGES FOR LOSS OF GOODWILL, WORK STOPPAGE, COMPUTER FAILURE OR MALFUNCTION, OR ANY AND ALL OTHER COMMERCIAL DAMAGES OR LOSSES, EVEN IF SUCH PARTY SHALL HAVE BEEN INFORMED OF THE POSSIBILITY OF SUCH DAMAGES. THIS LIMITATION OF LIABILITY SHALL NOT APPLY TO LIABILITY FOR DEATH OR PERSONAL INJURY RESULTING FROM SUCH PARTY'S NEGLIGENCE TO THE EXTENT APPLICABLE LAW PROHIBITS SUCH LIMITATION. SOME JURISDICTIONS DO NOT ALLOW THE EXCLUSION OR LIMITATION OF INCIDENTAL OR CONSEQUENTIAL DAMAGES, SO THIS EXCLUSION AND LIMITATION MAY NOT APPLY TO YOU. 10. U.S. GOVERNMENT END USERS.

The Covered Code is a "commercial item," as that term is defined in 48 C.F.R. 2.101 (Oct. 1995), consisting of "commercial computer software" and "commercial computer software documentation," as such terms are used in 48 C.F.R. 12.212 (Sept. 1995). Consistent with 48 C.F.R. 12.212 and 48 C.F.R. 227.7202-1 through 227.7202-4 (June 1995), all U.S. Government End Users acquire Covered Code with only those rights set forth herein.

## 11. MISCELLANEOUS.

This License represents the complete agreement concerning subject matter hereof. If any provision of this License is held to be unenforceable, such provision shall be reformed only to the extent necessary to make it enforceable. This License shall be governed by California law provisions (except to the extent applicable law, if any, provides otherwise), excluding its conflict-of-law provisions. With respect to disputes in which at least one party is a citizen of, or an entity chartered or registered to do business in the United States of America, any litigation relating to this License shall be subject to the jurisdiction of the Federal Courts of the Northern District of California, with venue lying in Santa Clara County, California, with the losing party responsible for costs, including without limitation, court costs and reasonable attorneys' fees and expenses. The application of the United Nations Convention on Contracts for the International Sale of Goods is expressly excluded. Any law or regulation which

provides that the language of a contract shall be construed against the drafter shall not apply to this License.

## 12. RESPONSIBILITY FOR CLAIMS.

As between Initial Developer and the Contributors, each party is responsible for claims and damages arising, directly or indirectly, out of its utilization of rights under this License and You agree to work with Initial Developer and Contributors to distribute such responsibility on an equitable basis. Nothing herein is intended or shall be deemed to constitute any admission of liability.

## 13. MULTIPLE-LICENSED CODE.

Initial Developer may designate portions of the Covered Code as Multiple-Licensed. Multiple-Licensed means that the Initial Developer permits you to utilize portions of the Covered Code under Your choice of the MPL or the alternative licenses, if any, specified by the Initial Developer in the file described in Exhibit A.

### EXHIBIT A -Mozilla Public License.

The contents of this file are subject to the Mozilla Public License Version 1.1 (the "License"); you may not use this file except in compliance with the License. You may obtain a copy of the License at <http://www.mozilla.org/MPL/Software> distributed under the License is distributed on an "AS IS" basis, WITHOUT WARRANTY OF ANY KIND, either express or implied. See the License for the specific language governing rights and limitations under the License.

The Original Code is \_\_\_\_\_.

The Initial Developer of the Original Code is \_\_\_\_\_; Portions created by \_\_\_\_\_ are Copyright (C) \_\_\_\_\_, All Rights Reserved.

Contributor(s): \_\_\_\_\_.

Alternatively, the contents of this file may be used under the terms of the \_\_\_\_\_ license (the [\_\_\_\_\_] License), in which case the provisions of [\_\_\_\_\_] License are applicable instead of those above. If you wish to allow use of your version of this file only under the terms of the [\_\_\_\_\_] License and not to allow others to use your version of this file under the MPL, indicate your decision by deleting the provisions above and replace them with the notice and other provisions required by the [\_\_\_\_\_] License. If you do not delete the provisions above, a recipient may use your version of this file under either the MPL or the [\_\_\_\_\_] License.\*

[NOTE: The text of this Exhibit A may differ slightly from the text of the notices in the Source Code files of the Original Code. You should use the text of this Exhibit A rather than the text found in the Original Code Source Code for Your Modifications

## The Independent JPEG Group's JPEG Software

The software included in this product contains copyrighted software that is licensed under the JPEG license.

- JPEG license
- Code project . Generating Outline OpenGL, Libjpeg

This distribution contains the sixth public release of the Independent JPEG Group's free JPEG software. You are welcome to redistribute this software and to use it for any purpose, subject to the conditions under LEGAL ISSUES, below.

Serious users of this software (particularly those incorporating it into larger programs) should contact IJG at [jpeg-info@uunet.uu.net](mailto:jpeg-info@uunet.uu.net) to be added to our electronic mailing list. Mailing list members are notified of updates and have a chance to participate in technical discussions, etc.

This software is the work of Tom Lane, Philip Gladstone, Jim Boucher, Lee Crocker, Julian Minguijon, Luis Ortiz, George Phillips, Davide Rossi, Guido Vollbeding, Ge' Weijers, and other members of the Independent JPEG Group.

IJG is not affiliated with the official ISO JPEG standards committee.

## LEGAL ISSUES

=====

### In plain English:

1. We don't promise that this software works. (But if you find any bugs, please let us know!)
2. You can use this software for whatever you want. You don't have to pay us.
3. You may not pretend that you wrote this software. If you use it in a program, you must acknowledge somewhere in your documentation that you've used the IJG code.

### In legalese:

The authors make NO WARRANTY or representation, either express or implied, with respect to this software, its quality, accuracy, merchantability, or fitness for a particular purpose. This software is provided "AS IS", and you, its user, assume the entire risk as to its quality and accuracy.

This software is copyright (C) 1991-1998, Thomas G. Lane. All Rights Reserved except as specified below.

Permission is hereby granted to use, copy, modify, and distribute this software (or portions thereof) for any purpose, without fee, subject to these conditions:

- (1) If any part of the source code for this software is distributed, then this README file must be included, with this copyright and no-warranty notice unaltered; and any additions, deletions, or changes to the original files must be clearly indicated in accompanying documentation.
- (2) If only executable code is distributed, then the accompanying documentation must state that "this software is based in part on the work of the Independent JPEG Group".
- (3) Permission for use of this software is granted only if the user accepts full responsibility for any undesirable consequences; the authors accept NO LIABILITY for damages of any kind.

These conditions apply to any software derived from or based on the IJG code, not just to the unmodified library. If you use our work, you ought to acknowledge us.

Permission is NOT granted for the use of any IJG author's name or company name in advertising or publicity relating to this software or products derived from it. This software may be referred to only as "the Independent JPEG Group's software".

We specifically permit and encourage the use of this software as the basis of commercial products, provided that all warranty or liability claims are assumed by the product vendor.

ansi2knr.c is included in this distribution by permission of L. Peter Deutsch, sole proprietor of its copyright holder, Aladdin Enterprises of Menlo Park, CA.

ansi2knr.c is NOT covered by the above copyright and conditions, but instead by the usual distribution terms of the Free Software Foundation; principally, that you must include source code if you redistribute it. (See the file ansi2knr.c for full details.) However, since ansi2knr.c is not needed as part of any program generated from the IJG code, this does not limit you more than the foregoing paragraphs do.

The Unix configuration script "configure" was produced with GNU Autoconf. It is copyright by the Free Software Foundation but is freely distributable. The same holds for its supporting scripts (config.sub, ltcconfig, ltmain.sh). Another support script, install-sh, is copyright by M.I.T. but is also freely distributable.

It appears that the arithmetic coding option of the JPEG spec is covered by patents owned by IBM, AT&T, and Mitsubishi. Hence arithmetic coding cannot legally be used without obtaining one or more licenses. For this reason, support for arithmetic coding has been removed from the free JPEG software. (Since arithmetic coding provides only a marginal gain over the unpatented Huffman mode, it is unlikely that very many implementations will support it.) So far as we are aware, there are no patent restrictions on the remaining code.

The IJG distribution formerly included code to read and write GIF files. To avoid entanglement with the Unisys LZW patent, GIF reading support has been removed altogether, and the GIF writer has been simplified to produce "uncompressed GIFs". This technique does not use the LZW algorithm; the resulting GIF files are larger than usual, but are readable by all standard GIF decoders.

We are required to state that

\*The Graphics Interchange Format(c) is the Copyright property of CompuServe Incorporated. GIF(sm) is a Service Mark property of CompuServe Incorporated.\*

## T-Kernel License

---

- This Product uses the Source Code of T-Kernel under T-License granted by the T-Engine Forum([www.t-engine.org](http://www.t-engine.org))

---

### T-License [License Agreement for Source Code of T-Kernel]

established by T-Engine Forum  
on January 23, 2004  
revised on June 17, 2004  
revised on December 21, 2006  
revised on March 24, 2009

### Article 1. Scope of License Agreement

1. This License Agreement sets forth copyrights and the terms and conditions of use applicable to the source code of T-Kernel distributed by T-Engine Forum and any derivative work created therefrom.

### Article 2. Definition

1. "T-Kernel" means a real-time operating system controlled and distributed by T-Engine Forum on behalf of the copyright holder thereof.
2. "Source Code" means a source program, including related comments and documentations, for the T-Kernel and the Ported Source Code defined in Article 2.8 which is registered with T-Engine Forum.
3. "Hardware-dependent Part" means the part of the Source Code which depends on hardware and needs to be changed when the Source Code is ported and operated on the target hardware, and is designated and separated as such part.
4. "Compiler-dependent Part" means the part of the Source Code which depends on compiler and needs to be changed when the Source Code is ported and operated on the target hardware, and is designated and separated as such part.
5. "Header File" means the part of the Source Code which contains definitions necessary to develop application programs.
6. "T-Engine Hardware" means the hardware which is manufactured in accordance with the T-Engine Hardware specifications or the  $\mu$ T-Engine Hardware specifications issued by T-Engine Forum, and registered with T-Engine Forum.
7. "Similar Hardware to T-Engine Hardware" means any hardware (including software which emulates hardware) other than that defined in Article 2.6 above, on which the T-Kernel can be operated.
8. "Ported Source Code" means a source program produced from the Source Code by modifying only its Hardwaredependent Part and/or Compiler-dependent Part to enable it to be operated on the T-Engine Hardware or the Similar Hardware to T-Engine Hardware. The Ported Source Code which is registered with T-Engine Forum shall be included in the Source Code.
9. "Modified Source Code" means a source program modified from the Source Code for the purpose of improving its performance, increasing or decreasing its function, and the like. The Ported Source Code shall not be included in the Modified Source Code.
10. "Binary Code" means an executable code form which is created by compiling programs, which include all or part of the Source Code or the Modified Source Code.
11. "Derivative Work" means the Modified Source Code or the Binary Code.
12. "Embedded Product" means any product which operates with executable code form of the Source Code, the Modified Source Code or the Binary Code loaded on its hardware.
13. "End User" means a consumer who uses the Embedded Product.
14. "System Developer" means any person who develops the Embedded Product by itself or has a third party develop the same, and provides, whether with or without payment, the End User with the Embedded Product.
15. "Distributor of Modification" means any person who produces the Modified Source Code and, whether with or without payment, distributes the same to any third party.

**16.** "Patch for Modification" means a difference, program, system, or the like in order to create the Modified Source Code from the Source Code or the Binary Code thereof.

**17.** "Vicarious Execution of Patch Processing" means vicarious execution service to create the Modified Source Code applying the Patch for Modification to the Source Code or the Binary Code thereof.

**18.** "Source Code User" means a person who uses the Source Code.

**19.** "Distribution" means any of the following acts:

1. to transmit a work to a large number of specific persons through the Internet communication, broadcasting, and the like;
2. to transmit a work to the general public through the Internet communication, broadcasting, and the like automatically in response to a request from the public; and
3. to distribute a copy of a work to the general public or a large number of specific persons.

#### **Article 3. Copyright**

1. The copyrights of the Source Code shall be owned by Ken Sakamura.

#### **Article 4. License of Source Code**

1. As provided for in this Article, T-Engine Forum shall provide, and grant a license to use, the Source Code free of charge to any person who has taken the necessary procedure for registration as prescribed by T-Engine Forum and agreed to the T-License.

2. The Source Code shall be distributed exclusively by T-Engine Forum. Any person who obtains the Source Code under Article 4.1 above shall not make any re-Distribution of the Source Code.

3. In accordance with the license granted under Article 4.1 above, the Source Code User may perform the following acts:

1. to copy and/or modify the Source Code provided by T-Engine Forum hereunder for its own research, development and the like.
  2. to run the Source Code provided by T-Engine Forum hereunder for its own research, development and the like.
  3. to run the Source Code modified in accordance with the provision of Article 4.3 (1) above for its own research, development and the like.
  4. to distribute the Binary Code created from the Source Code provided by T-Engine Forum hereunder or from the Source Code modified in accordance with the provision of Article 4.3 (1) above.
4. In accordance with the license granted under Article 4.1 above, the System Developer may perform the following acts:

1. to perform any and all acts set forth in the Article 4.3 above.
2. to develop and manufacture the Embedded Product containing the Binary Code, and, whether with or without payment, provide the End User with the same and make the Binary Code available to the End User on the Embedded Product.

5. The Source Code User and the System Developer shall be obligated to give a notice that the Source Code is used, in such a way as separately specified by T-Engine Forum, when they use the Source Code or the Binary Code, or make the Binary Code available for the End User on the Embedded Product.

#### **Article 5. Distribution of Modified Source Code**

1. Any of A- members of T-Engine Forum may become the Distributor of Modification by obtaining the approval of T-Engine Forum through the registration procedure as prescribed by the Forum provided that only the department of the A- member which has taken the registration procedure may distribute the Modified Source Code in such a way as provided for in this Article as long as it holds the Amembership.

2. The Distributor of Modification may create the Modified Source Code based on the Source Code provided by T-Engine Forum and the Patch for Modification to be applied to create such Modified Source Code from the Source Code.

3. The Distributor of Modification shall, prior to the distribution, inform T-Engine Forum of and register a name and description of the Modified Source Code in such a way as specified by T-Engine Forum.

4. The Distributor of Modification shall determine the name of the Modified Source Code subject to the rules separately established by T-Engine Forum and publish an appropriate notice as required by the rules on the Patch for Modification and the Modified Source Code.

5. The Distributor of Modification may distribute the Modified Source Code to a third party, whether with or without payment, provided that the Distributor of Modification shall take the necessary measures to prohibit the third party from making the re-Distribution of the Modified Source Code.

6. Developer with the Patch for Modification. Provided, however, that the Distributor of Modification shall be obligated to confirm that the System Developer is the Source Code User duly licensed under Article 4.1.

7. The Distributor of Modification may perform the Vicarious Execution of Patch Processing for the System Developer.

8. The System Developer shall not distribute the Modified Source Code in further modified form to any third party as a stand-alone software product.

9. The System Developer may, under the same obligation as imposed in Article 4.5, make the Embedded Product available for the End User through use of the Patch for Modification distributed by the Distributor of Modification or the Derivative Works obtained through the Vicarious Execution of Patch Processing.

#### **Article 6. Distribution and Registration of the Ported Source Code**

1. The Source Code User and the System Developer may, whether with or without charge, distribute to any third party only the following parts of the Ported

Source Code on the T-Engine Hardware or the Similar Hardware to T-Engine Hardware:

1. The Hardware-dependent Part and/or Compiler-dependent Part; provided that the Source Code User and the System Developer shall inform T-Engine Forum of, and T-Engine Forum may publish, a method for distributing said Part(s) to third parties.

2. The Header File; provided that the Header File shall be distributed together with the Binary Code of the Ported Source Code.

2. Any member of T-Engine Forum may request T-Engine Forum to register and distribute, as an original source code for T-Kernel, the Ported Source Code on the T-Engine Hardware or the Similar Hardware to T-Engine Hardware.

3. Any member of T-Engine Forum who requests the distribution mentioned in the preceding paragraph shall accede to the following conditions:

1. The member shall confirm that the object hardware is the T-Engine Hardware or the Similar Hardware to T-Engine Hardware.
2. The member shall provide T-Engine Forum with a complete set of operational environment for the object hardware and T-Kernel free of charge when requesting the distribution.
3. The member shall submit test results of the Ported Source Code to T-Engine Forum when requesting the distribution.

4. In the event that T-Engine Forum accepts the request mentioned in Article 6.2, T-Engine Forum shall register and distribute the Ported Source Code as the Source Code for T-Kernel. Provided, however, that the Ported Source Code may be treated in the same way as the Modified Source Code until the time of registration hereunder.

5. The provision set forth in Article 3 shall apply to the Ported Source Code registered in accordance with this Article.

#### **Article 7. Use for Other Purpose**

1. Any use of the Source Code, the Modified Source Code or the Ported Source Code other than those stipulated in Articles 4, 5 and 6 shall be subject to the prior approval of T-Engine Forum.

#### **Article 8. Limited Warranty**

1. T-Engine Forum and the copyright holder of the Source Code warrant that the Source Code does not infringe third party's copyrights. Provided, however, that T-Engine Forum and the copyright holder of the Source Code make no warranty as to the Hardware-dependent Part and/or Compiler-dependent Part set forth in Article 6.2 in the Ported Source Code by any third party.

2. Neither T-Engine Forum nor the copyright holder of the Source Code warrants that the Source Code will fit for any particular purpose of the Source Code User.

3. Neither T-Engine Forum nor the copyright holder of the Source Code warrants that the Source Code does not infringe any third party's industrial property rights. In no event shall T-Engine Forum and the copyright holder of the Source Code be liable for any dispute which may arise between the Source Code User and a third party in connection with the third party's industrial property rights.

#### **Article 9. Indemnity**

1. Neither T-Engine Forum nor the copyright holder of the Source Code shall be liable for any damages (including, but not limited to, damages resulting from loss of profit, business interruption, loss of business information or any other pecuniary damage) arising out of use or impossibility of use of the Source Code, even if T-Engine Forum and the copyright holder have been informed of the possibility of such damages.

#### **Article 10. Breach of Agreement**

1. In case that T-Engine Forum considers that this License Agreement is breached or that the popularization of T-Kernel is obstructed, T-Engine Forum shall take measures to correct such breach or such obstruction, take measures on the ground of copyright infringement, or take any other necessary measures against the breaching person or the obstructing person, regardless of whether or not the said person is a member of T-Engine Forum.

2. In case of breach of this License Agreement by a member of T-Engine Forum, T-Engine Forum may take appropriate measures against the member; for example, the member is disqualified from membership, depending on what kind of breach has been committed by it.

3. Any legal dispute which may arise in relation to any breach of this License Agreement shall be subject to the exclusive jurisdiction of the Tokyo District Court.

#### **Article 11. Governing Law and Language**

1. This License Agreement shall be governed by and interpreted under the laws of Japan.

2. This License Agreement is executed in both Japanese text and English text provided that the Japanese text shall govern the interpretation and performance of this License Agreement.

### **Apache License 2.0**

Component	Name License	URL
mDNSResponder_bonjour	Apache License 2.0	<a href="http://www.apache.org/licenses/LICENSE-2.0">http://www.apache.org/licenses/LICENSE-2.0</a>

#### **TERMS AND CONDITIONS FOR USE, REPRODUCTION, AND DISTRIBUTION**

1. Definitions.

"License" shall mean the terms and conditions for use, reproduction, and distribution as defined by Sections 1 through 9 of this document.

"Licensor" shall mean the copyright owner or entity authorized by the copyright owner that is granting the License.

"Legal Entity" shall mean the union of the acting entity and all other entities that control, are controlled by, or are under common control with that entity. For the purposes of this definition, "control" means (i) the power, direct or indirect, to cause the direction or management of such entity, whether by contract or otherwise, or (ii) ownership of fifty percent (50%) or more of the outstanding shares, or (iii) beneficial ownership of such entity.

"You" (or "Your") shall mean an individual or Legal Entity exercising permissions granted by this License. "Source" form shall mean the preferred form for making modifications, including but not limited to software source code, documentation source, and configuration files.

"Object" form shall mean any form resulting from mechanical transformation or translation of a Source form, including but not limited to compiled object code, generated documentation, and conversions to other media types.

"Work" shall mean the work of authorship, whether in Source or Object form, made available under the License, as indicated by a copyright notice that is included in or attached to the work (an example is provided in the Appendix below).

"Derivative Works" shall mean any work, whether in Source or Object form, that is based on (or derived from) the Work and for which the editorial revisions, annotations, elaborations, or other modifications represent, as a whole, an original work of authorship. For the purposes of this License, Derivative Works shall not include works that remain separable from, or merely link (or bind by name) to the interfaces of, the Work and Derivative Works thereof.

"Contribution" shall mean any work of authorship, including the original version of the Work and any modifications or additions to that Work or Derivative Works thereof, that is intentionally submitted to Licensor for inclusion in the Work by the copyright owner or by an individual or Legal Entity authorized to submit on behalf of the copyright owner. For the purposes of this definition, "submitted" means any form of electronic, verbal, or written communication sent to the Licensor or its representatives, including but not limited to communication on electronic mailing lists, source code control systems, and issue tracking systems that are managed by, or on behalf of, the Licensor for the purpose of discussing and improving the Work, but excluding communication that is conspicuously marked or otherwise designated in writing by the copyright owner as "Not a Contribution." "Contributor" shall mean Licensor and any individual or Legal Entity on behalf of whom a Contribution has been received by Licensor and subsequently incorporated within the Work.

- Grant of Copyright License. Subject to the terms and conditions of this License, each Contributor hereby grants to You a perpetual, worldwide, non-exclusive, no-charge, royalty-free, irrevocable copyright license to reproduce, prepare Derivative Works of, publicly display, publicly perform, sublicense, and distribute the Work and such Derivative Works in Source or Object form.
- Grant of Patent License. Subject to the terms and conditions of this License, each Contributor hereby grants to You a perpetual, worldwide, non-exclusive, no-charge, royalty-free, irrevocable (except as stated in this section) patent license to make, have made, use, offer to sell, sell, import, and otherwise transfer the Work, where such license applies only to those patent claims licensable by such Contributor that are necessarily infringed by their Contribution(s) alone or by combination of their Contribution(s) with the Work to which such Contribution(s) was submitted. If You institute patent litigation against any entity (including a crossclaim or counterclaim in a lawsuit) alleging that the Work or a Contribution incorporated within the Work constitutes direct or contributory patent infringement, then any patent licenses granted to You under this License for that Work shall terminate as of the date such litigation is filed.

- Redistribution. You may reproduce and distribute copies of the Work or Derivative Works thereof in any medium, with or without modifications, and in Source or Object form, provided that You meet the following conditions:

- You must give any other recipients of the Work or Derivative Works a copy of this License; and
- You must cause any modified files to carry prominent notices stating that You changed the files; and
- You must retain, in the Source form of any Derivative Works that You distribute, all copyright, patent, trademark, and attribution notices from the Source form of the Work, excluding those notices that do not pertain to any part of the Derivative Works; and
- If the Work includes a "NOTICE" text file as part of its distribution, then any Derivative Works that You distribute must include a readable copy of the attribution notices contained within such NOTICE file, excluding those notices that do not pertain to any part of the Derivative Works, in at least one of the following places: within a NOTICE text file distributed as part of the Derivative Works; within the Source form or documentation, if provided along with the Derivative Works; or, within a display generated by the Derivative Works, if and wherever such third-party notices normally appear. The contents of the NOTICE file are for informational purposes only and do not modify the License. You may add Your own attribution notices within Derivative Works that You distribute, alongside or as an addendum to the NOTICE text from the Work, provided that such additional attribution notices cannot be construed as modifying the License.

You may add Your own copyright statement to Your modifications and may provide additional or different license terms and conditions for use, reproduction, or distribution of Your modifications, or for any such Derivative Works as a whole, provided Your use, reproduction, and distribution of the Work otherwise complies with the conditions stated in this License.

- Submission of Contributions. Unless You explicitly state otherwise, any Contribution intentionally submitted for inclusion in the Work by You to the Licensor shall be under the terms and conditions of this License, without any additional terms or conditions. Notwithstanding the above, nothing herein shall supersede or modify the terms of any separate license agreement you may have executed with Licensor regarding such Contributions.

- Trademarks. This License does not grant permission to use the trade names, trademarks, service marks, or product names of the Licensor, except as required for reasonable and customary use in describing the origin of the Work and reproducing the content of the NOTICE file.

- Disclaimer of Warranty. Unless required by applicable law or agreed to in writing, Licensor provides the Work (and eachContributor provides its Contributions) on an "AS IS" BASIS, WITHOUT WARRANTIES OR CONDITIONS OF ANY KIND, either express or implied, including, without limitation, any warranties or conditions of TITLE, NON-INFRINGEMENT, MERCHANTABILITY, or FITNESS FOR A PARTICULAR PURPOSE. You are solely responsible for determining the appropriateness of using or redistributing the Work and assume any risks associated with Your exercise of permissions under this License.

- Limitation of Liability. In no event and under no legal theory, whether in tort (including negligence), contract, or otherwise, unless required by applicable law (such as deliberate and grossly negligent acts) or agreed to in writing, shall any Contributor be liable to You for damages, including any direct, indirect, special, incidental, or consequential damages of any character arising as a result of this License or out of the use or inability to use the Work (including but not limited to damages for loss of goodwill, work stoppage, computer failure or malfunction, or any and all other commercial damages or losses), even if such Contributor has been advised of the possibility of such damages.

- Accepting Warranty or Additional Liability. While redistributing the Work or Derivative Works thereof, You may choose to offer, and charge a fee for, acceptance of support, warranty, indemnity, or other liability obligations and/or rights consistent with this License. However, in accepting such obligations, You may act only on Your own behalf and on Your sole responsibility, not on behalf of any other Contributor, and only if You agree to indemnify, defend, and hold each Contributor harmless for any liability incurred by, or claims asserted against, such Contributor by reason of your accepting any such warranty or additional liability.

## END OF TERMS AND CONDITIONS

APPENDIX: How to apply the Apache License to your work.

To apply the Apache License to your work, attach the following boilerplate notice, with the fields enclosed by brackets "[ ]" replaced with your own identifying information. (Don't include the brackets!) The text should be enclosed in the appropriate comment syntax for the file format. We also recommend that a file or class name and description of purpose be included on the same "printed page" as the copyright notice for easier identification within third-party archives.

Copyright [yyyy] [name of copyright owner]

Licensed under the Apache License, Version 2.0 (the "License"); you may not use this file except in compliance with the License. You may obtain a copy of the License at <http://www.apache.org/licenses/LICENSE-2.0>

Unless required by applicable law or agreed to in writing, software distributed under the License is distributed on an "AS IS" BASIS, WITHOUT WARRANTIES OR CONDITIONS OF ANY KIND, either express or implied. See the License for the specific language governing permissions and limitations under the License.

## BZip2 License

This program, "bzip2", the associated library "libbzip2", and all documentation, are copyright (C) 1996-2007 Julian R Seward. All rights reserved.

Component Name	License	URL
bzip2-1.0.6	Bzip2	<a href="http://www.bzip.org/">http://www.bzip.org/</a>

Redistribution and use in source and binary forms, with or without modification, are permitted provided that the following conditions are met:

- Redistributions of source code must retain the above copyright notice, this list of conditions and the following disclaimer.
- The origin of this software must not be misrepresented; you must not claim that you wrote the original software. If you use this software in a product, an acknowledgment in the product documentation would be appreciated but is not required.
- Altered source versions must be plainly marked as such, and must not be misrepresented as being the original software.
- The name of the author may not be used to endorse or promote products derived from this software without specific prior written permission.

THIS SOFTWARE IS PROVIDED BY THE AUTHOR "AS IS" AND ANY EXPRESS OR IMPLIED WARRANTIES, INCLUDING, BUT NOT LIMITED TO, THE IMPLIED WARRANTIES OF MERCHANTABILITY AND FITNESS FOR A PARTICULAR PURPOSE ARE DISCLAIMED. IN NO EVENT SHALL THE AUTHOR BE LIABLE FOR ANY DIRECT, INDIRECT, INCIDENTAL, SPECIAL, EXEMPLARY, OR CONSEQUENTIAL DAMAGES (INCLUDING, BUT NOT LIMITED TO, PROCUREMENT OF SUBSTITUTE GOODS OR SERVICES; LOSS OF USE, DATA, OR PROFITS; OR BUSINESS INTERRUPTION) HOWEVER CAUSED AND ON ANY THEORY OF LIABILITY, WHETHER IN CONTRACT, STRICT LIABILITY, OR TORT (INCLUDING NEGLIGENCE OR OTHERWISE) ARISING IN ANY WAY OUT OF THE USE OF THIS SOFTWARE, EVEN IF ADVISED OF THE POSSIBILITY OF SUCH DAMAGE.

Julian Seward, [jseward@bzip.org](mailto:jseward@bzip.org)

bzip2/libbzip2 version 1.0.5 of 10 December 2007

## University of Illinois / NCSA Open Source License

Copyright (c) 1999-2007, The Board of Trustees of the University of Illinois All Rights Reserved.

Component Name	License
iperf-2.0.5	University of Illinois / NCSA Open Source

iperf performance test

Mark Gates

Ajay Tirumala

Jim Ferguson

Jon Dugan

Feng Qin

Kevin Gibbs

John Estabrook

National Laboratory for Applied Network Research

National Center for Supercomputing Applications

University of Illinois at Urbana-Champaign

<http://www.ncsa.uiuc.edu>

Permission is hereby granted, free of charge, to any person obtaining a copy of this software (iperf) and associated documentation files (the "Software"), to deal in the Software without restriction, including without limitation the rights to use, copy, modify, merge, publish, distribute, sublicense, and/or sell copies of the Software, and to permit persons to whom the Software is furnished to do so, subject to the following conditions:

Redistributions of source code must retain the above copyright notice, this list of conditions and the following disclaimers.

Redistributions in binary form must reproduce the above copyright notice, this list of conditions and the following disclaimers in the documentation and/or other materials provided with the distribution.

Neither the names of the University of Illinois, NCSA, nor the names of its contributors may be used to endorse or promote products derived from this Software without specific prior written permission. THE SOFTWARE IS PROVIDED "AS IS", WITHOUT WARRANTY OF ANY KIND, EXPRESS OR IMPLIED, INCLUDING BUT NOT LIMITED TO THE WARRANTIES OF MERCHANTABILITY, FITNESS FOR A PARTICULAR PURPOSE AND NON-INFRINGEMENT. IN NO EVENT SHALL THE CONTRIBUTORS OR COPYRIGHT HOLDERS BE LIABLE FOR ANY CLAIM, DAMAGES OR OTHER LIABILITY, WHETHER IN AN ACTION OF CONTRACT, TORT OR OTHERWISE, ARISING FROM, OUT OF OR IN CONNECTION WITH THE SOFTWARE OR THE USE OR OTHER DEALINGS IN THE SOFTWARE.

## PHP 3.01 License

The PHP License, version 3.01 Copyright (c) 1999 - 2010 The PHP Group. All rights reserved.

Component Name	License	URL
php-5.2.17	PHP 3.01	<a href="http://www.php.net/distributions">http://www.php.net/distributions</a>

Redistribution and use in source and binary forms, with or without modification, is permitted provided that the following conditions are met:

1. Redistributions of source code must retain the above copyright notice, this list of conditions and the following disclaimer.
2. Redistributions in binary form must reproduce the above copyright notice, this list of conditions and the following disclaimer in the documentation and/or other materials provided with the distribution.
3. The name "PHP" must not be used to endorse or promote products derived from this software without prior written permission. For written permission, please contact [group@php.net](mailto:group@php.net).
4. Products derived from this software may not be called "PHP", nor may "PHP" appear in their name, without prior written permission from [group@php.net](mailto:group@php.net). You may indicate that your software works in conjunction with PHP by saying "Foo for PHP" instead of calling it "PHP Foo" or "phpfoo".
5. The PHP Group may publish revised and/or new versions of the license from time to time. Each version will be given a distinguishing version number. Once covered code has been published under a particular version of the license, you may always continue to use it under the terms of that version. You may also choose to use such covered code under the terms of any subsequent version of the license published by the PHP Group. No one other than the PHP Group has the right to modify the terms applicable to covered code created under this License.
6. Redistributions of any form whatsoever must retain the following acknowledgment: "This product includes PHP software, freely available from <<http://www.php.net/software/>>".

THIS SOFTWARE IS PROVIDED BY THE PHP DEVELOPMENT TEAM "AS IS" AND ANY EXPRESSED OR IMPLIED WARRANTIES, INCLUDING, BUT NOT LIMITED TO, THE IMPLIED WARRANTIES OF MERCHANTABILITY AND FITNESS FOR A PARTICULAR PURPOSE ARE DISCLAIMED. IN NO EVENT SHALL THE PHP DEVELOPMENT TEAM OR ITS CONTRIBUTORS BE LIABLE FOR ANY DIRECT, INDIRECT, INCIDENTAL, SPECIAL, EXEMPLARY, OR CONSEQUENTIAL DAMAGES (INCLUDING, BUT NOT LIMITED TO, PROCUREMENT OF SUBSTITUTE GOODS OR SERVICES; LOSS OF USE, DATA, OR PROFITS; OR BUSINESS INTERRUPTION) HOWEVER CAUSED AND ON ANY THEORY OF LIABILITY, WHETHER IN CONTRACT, STRICT LIABILITY, OR TORT (INCLUDING NEGLIGENCE OR OTHERWISE) ARISING IN ANY WAY OUT OF THE USE OF THIS SOFTWARE, EVEN IF ADVISED OF THE POSSIBILITY OF SUCH DAMAGE.

This software consists of voluntary contributions made by many individuals on behalf of the PHP Group. The PHP Group can be contacted via Email at [group@php.net](mailto:group@php.net).

For more information on the PHP Group and the PHP project, please see <<http://www.php.net>>. PHP includes the Zend Engine, freely available at <<http://www.zend.com>>.

## zlib / libpng License

This software is provided 'as-is', without any express or implied warranty. In no event will the authors be held liable for any damages arising from the use of this software.

Component Name	License	URL
zlib-1.2.8	zlib / libpng	<a href="http://zlib.net/">http://zlib.net/</a>

Copyright (C) 1995-2010 Jean-loup Gailly and Mark Adler

Permission is granted to anyone to use this software for any purpose, including commercial applications, and to alter it and redistribute it freely, subject to the following restrictions:

1. The origin of this software must not be misrepresented; you must not claim that you wrote the original software. If you use this software in a product, an acknowledgment in the product documentation would be appreciated but is not required.
2. Altered source versions must be plainly marked as such, and must not be misrepresented as being the original software.
3. This notice may not be removed or altered from any source distribution.

Jean-loup Gailly Mark Adler

[jloup@gzip.org](mailto:jloup@gzip.org) [madler@alummi.caltech.edu](mailto:madler@alummi.caltech.edu)

The data format used by the zlib library is described by RFCs (Request for Comments) 1950 to 1952 in the files <http://www.ietf.org/rfc/rfc1950.txt> (zlib format), [rfc1951.txt](http://www.ietf.org/rfc/rfc1951.txt) (deflate format) and [rfc1952.txt](http://www.ietf.org/rfc/rfc1952.txt) (gzip format).

Portions of this software are copyright 1996-2002 The FreeType Project ([www.freetype.org](http://www.freetype.org)). All rights reserved.



Any changes or modifications in construction of this device which are not expressly approved by the party responsible for compliance could void the user's authority to operate the equipment.

This device complies with part 15 of the FCC Rules. Operation is subject to the following two conditions: (1) This device may not cause harmful interference, and (2) this device must accept any interference received, including interference that may cause undesired operation.

This equipment has been tested and found to comply with the limits for a Class A digital device, pursuant to part 15 of the FCC Rules. These limits are designed to provide reasonable protection against harmful interference when the equipment is operated in a commercial environment.

This equipment generates, uses, and can radiate radio frequency energy and, if not installed and used in accordance with the instruction manual, may cause harmful interference to radio communications. Operation of this equipment in a residential area is likely to cause harmful interference in which case the user will be required to correct the interference at his own expense.



Hanwha Techwin cares for the environment at all product manufacturing stages, and is taking measures to provide customers with more environmentally friendly products.

The Eco mark represents Hanwha Techwin's devotion to creating environmentally friendly products, and indicates that the product satisfies the EU RoHS Directive.



### Correct Disposal of This Product (Waste Electrical & Electronic Equipment)

(Applicable in the European Union and other European countries with separate collection systems)

This marking on the product, accessories or literature indicates that the product and its electronic accessories (e.g. charger, headset, USB cable) should not be disposed of with other household waste at the end of their working life. To prevent possible harm to the environment or human health from uncontrolled waste disposal, please separate these items from other types of waste and recycle them responsibly to promote the sustainable reuse of material resources.

Household users should contact either the retailer where they purchased this product, or their local government office, for details of where and how they can take these items for environmentally safe recycling.

Business users should contact their supplier and check the terms and conditions of the purchase contract. This product and its electronic accessories should not be mixed with other commercial wastes for disposal.



### Correct disposal of batteries in this product

(Applicable in the European Union and other European countries with separate battery return systems.)

This marking on the battery, manual or packaging indicates that the batteries in this product should not be disposed of with other household waste at the end of their working life. Where marked, the chemical symbols Hg, Cd or Pb indicate that the battery contains mercury, cadmium or lead above the reference levels in EC Directive 2006/66. If batteries are not properly disposed of, these substances can cause harm to human health or the environment.

To protect natural resources and to promote material reuse, please separate batteries from other types of waste and recycle them through your local, free battery return system.



---

**Head Office**

6, Pangyo-ro 319 beon-gil, Bundang-gu, Seongnam-si,  
Gyeonggi-do, 463-400 Rep. of KOREA  
Tel : +82.70.7147.8753 Fax : +82.31.8018.3740  
[www.hanwha-security.com](http://www.hanwha-security.com)

---

**Hanwha Techwin America**

500 Frank W. Burr Blvd. Suite 43 Teaneck, NJ 07666  
Toll Free +1.877.213.1222 Direct +1.201.325.6920  
Fax +1.201.373.0124  
[www.hanwhasecurity.com](http://www.hanwhasecurity.com)

---

**Hanwha Techwin Europe**

Heriot House, Heriot Road, Chertsey, Surrey, KT16 9DT, United Kingdom  
Tel +44.1932.57.8100 Fax +44.1932.57.8101  
[www.hanwha-security.eu](http://www.hanwha-security.eu)

---