

Smart Security Manager User Manual

VER 1.60 / Enterprise

overview

CONTENTS

OVERVIEW

2

- 2 Contents
- 5 Introduction on Smart Security Manager
- 8 Main features Smart Security Manager
- 9 Terms frequently used

INSTALLATION

10

- 10 Installation

GETTING STARTED

21

- 21 Checking installed installation
- 22 Getting Started with Smart Security Manager
- 23 Using SSM License Manager

SSM CONFIGURATION MANAGER

28

- 28 Login/Logout
- 30 System Settings
- 37 Option Setup
- 38 Device
- 56 Site
- 61 Camera Management
- 66 Layout Setting
- 72 Schedule Setup
- 74 Event
- 79 Record
- 86 Scheduled backup
- 90 Google Map
- 98 Federation

SSM CONSOLE

101

- 101 Log In / Out
- 103 SSM Console Screen Composition

LIVE VIEWER

108

- 108 Names and Functions of Live Viewer
- 110 Names and Features of Screen Indicators
- 111 Device
- 115 Camera List
- 116 Alarm Out and Control
- 117 Selecting Tile Pattern
- 117 Layout
- 126 Virtual Matrix Controller
- 129 Audio Broadcasting
- 130 PTZ Control
- 133 Event List
- 135 Playing Recorded Events
- 139 Live Video Screen
- 146 Digital Zoom
- 149 POS

EVENT VIEWER

151

- 151 Names and Functions of Event Viewer
- 152 Event Search

SEARCH VIEWER

158

- 158 Names and Functions of Search Viewer
- 168 Advanced Search
- 173 Masking Backup
- 174 Folder Search
- 175 POS Search
- 176 Backup

GOOGLE MAP VIEWER

178

- 178 Names and Functions of Google Maps Viewer screen
- 180 Names and Functions of Google Maps
- 181 Layer

PLUG-IN VIEWER

186

- 186 Plug-in viewer

overview

SETTING CONSOLE 188 Setting SSM Console

188

SSM SERVICE MANAGER 195 Service Manager

195

SSM RECORDING SERVER 199 SSM Recording Server ServiceManager

199

SSM HA 204 SSM-HA Description

209 HA Terminology and Installation

204

DASHBOARD 217 Before installation

218 Getting started

220 Dashboard

221 DASHBOARD

223 Detail

229 Trend

217

APPENDIX 231 Product Specification

233 List of ports used in SSM

234 Use Joystick

241 Open Source License Notification on the Product

231

INTRODUCTION ON SMART SECURITY MANAGER

Smart Security Manager is an application software that enables the accessing and controlling network devices from a remote PC.

Using this program, you may access and control your network devices via the Internet from anywhere, as well as monitoring connected camera.

It provides users with remote access and playback/search an environment for remote monitoring that employs ease and effectiveness.

Smart Security Manager Structure Overview

Smart Security Manager consists of the Console program in the client area and System Manager, Media Gateway and Recording Server in the server area.

- Console : Console provides monitoring and controlling user interface.
- System Manager : System Manager provides administration on all devices and users of the system.
- Media Gateway : Media Gateway's role is as the centralized relay server for the transmitting of video, PTZ control and events.
- Recording Server : It acts as a server that saves and broadcasts video from a camera.

Standalone type

All server components Installed onto one computer.

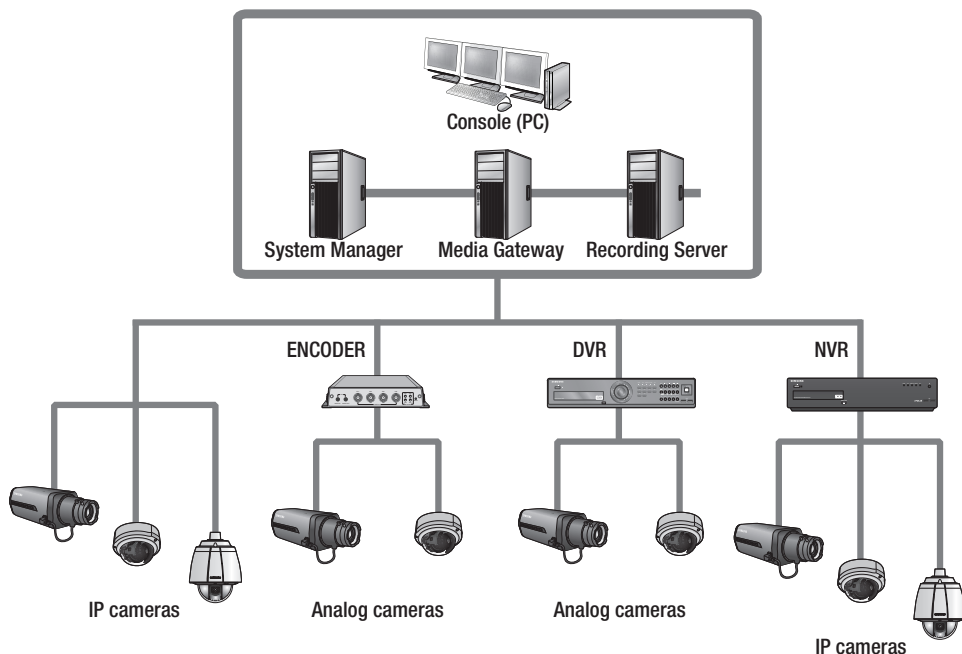

overview

Multi type

In case of distributed installation of the System Manager, Media Gateway and Console on multiple computers.

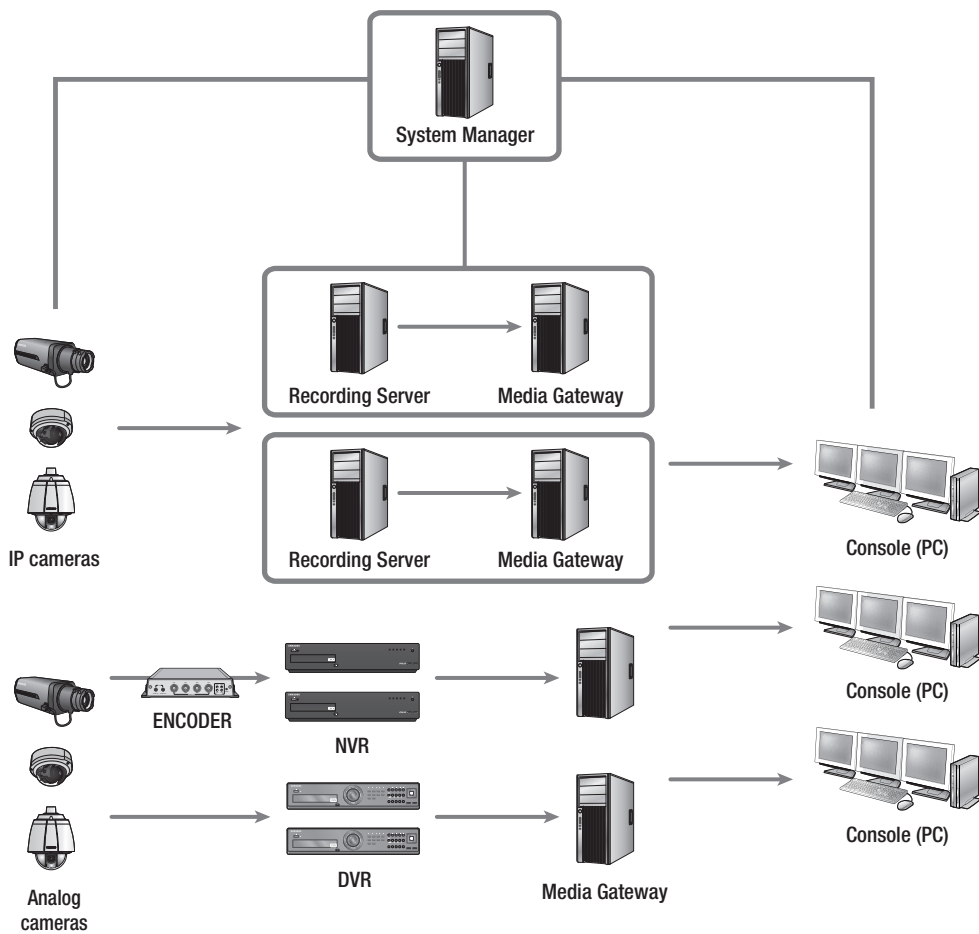

Supported Products

DVR

SRD-1670(D/DC)/1650(D/DC)/870(D/DC)/850(D/DC)/470(D)/440, SRD-1630(D)/1610(D)/830(D), SRD-1652D/852D, SRD-480D, SVR-1670/3200/1680(C)/1660(C)/1645/960(C)/945/480, SHR-2000/5000/6000/7000/8000 series, SVR-1650E/1640A/950E, SRD-1640/840/1641P/841P, SRD-442, SRD-1653D/1673D, SRD-1654D/854D, SRD-473D, SRD-443, SRD-1676D/1656D, SRD-876D/476D, SRD-1673DU, SRD-445, SRD-856/456, SRD-1680D/880D, SRD-482

Network Camera

SNB-7000/5000/3000/2000/1000/1001/3002, SNZ-5200, SNO-7080R/5080R/1080R, SNC-B2335/B2331/M300/1300/550/570, SNB-7002/7001/5001, SNO-7082RV, SNB-6004/6003, SNV-6084R, SNO-6084R, SNB-5004 / SNB-5003, SNO-6011R, SNV-6012M, SNV-5084, SNB-7004, SNO-7084R, SNV-7084/7084R, SNV-6013, SNB-6010

SND-7080/5080(F)/3080(F)/3080C(F)/1010/1080/1011/3082, SNV-7080/5080/3080/5010/3120/5080R/3082/1080/1080R, SND-560/460V, SNC-B5368/B5399, SNV-7082V, SND-7082V/7082FV, SND-6084/6083, SND-6084R, SND-7084/7084R

SNP-5200(H)/3430H/3370, 3371(TH)/3301(H)/3120(V/VH)/3302(H), SNC-C6225/C7225/C7478, SNP-3300A/1000A/3750/3350, SNP-6200/H, SNP-5300/H, SNP-6201/H, SNP-6200RH, SNP-6320/ 6320H SNF-7010, SNF-7010V, SNF-7010VM

SNP-6321/H, SNP-5430H, SNO-5084R, SNB-8000, SNV-8080, SNF-8010

SNO-L5083R, SNO-L6013R, SNO-L6083R, SNP-6320RH, SNP-5321H

SNO/V-8081R, SNB-9000, PNO-9080R, PNO/V/D-9081/9080, SNF-9010R

NVR

SRN-6450/3250, SNR-6400/3200, SRN-1670D/470D, SRN-1671, SRN-1000, SRN-4000, SRN-472S, SRN-1673S/873S/473S, XRN-2010/2011, PRN-4011, XRN-3010, VPM-4800/4400/5400/6400

Encoder

SPE-400/100/101, SPE-1600R, SNS-400/100

Controller

SPC-2000, AXIS-T8310, SPC-7000

Panomorph Lens

IMV1-1/3 Panomorph CS mount (SNB-5000 compatible)

SW NVR

NET-i ware_SNS_SF064/SNS_SF032/SNS_SF016/SNS_SF008/SNS_SF004, SSM-RS20/SSM-RS10/SSM-RS00, SSM-RS30

External I/O

Advantech ADAM-6050/6060/6066, MOXA NA-4010(M-1601, M-2601)

System Requirements

Item	Minimum	Recommended
CPU	Intel Core i5-4670 @ 3.40GHz	Intel Core i7-4770 @ 3.40GHz
RAM	4 GB or more	8 GB or more
Video Card	At least 512MB of memory (GeForce GT240)	At least 1024MB of memory (GeForce GTX760 GPU, GTX960 or higher and Driver version 368.69 or higher when CUDA decoder is used)
HDD	More than 20 GB of free space for installation - For operation, the system log database requires 10 GB or more free space.	
OS	<ol style="list-style-type: none"> 1. Console, Configuration Manager <ul style="list-style-type: none"> - Windows 7 32bit/64bit - Windows 8 32bit/64bit - Windows 8.1 32bit/64bit - Windows 10 32bit/64bit 2. MediaGateway <ul style="list-style-type: none"> - Windows 7 32bit/64bit - Windows 8 32bit/64bit - Windows 8.1 32bit/64bit - Windows 10 32bit/64bit - Windows Server 2008 R2 64bit - Windows Server 2012 32bit/64bit 3. System Manager <ul style="list-style-type: none"> - Windows Server 2008 64bit - Windows Server 2012 64bit - Windows Server 2012 R2 64bit 	



▪ For the recording server system specifications, refer to the annex. (Page 232)

Configurable monitoring systems according to the system performance

- Minimum Specifications : Allows access to 16 channels, with monitoring 16 channels at CIF resolution.
- Recommended Specifications : Allows access to 64 channels, with monitoring 64 channels at 4CIF resolution.

MAIN FEATURES SMART SECURITY MANAGER

- Live Viewer
 - Supports simultaneous video display of up to 64 monitoring tiles per monitor, maximum 4 monitors for 100 monitoring tiles
 - One footage file can save up to 1 hours worth of video
 - Supports full-screen mode
 - Place video feed at any desired tile using drag-n-drop
 - A simple double-click adds a video feed to the video screen
 - Supports sequenced automatic source switching

- Event Viewer
 - Provides search function for events and real-time logs
 - Provides 1-channel playback for events
 - Provides methods of acknowledging, recording, and search on an event
- Search Viewer
 - Up to 16 videos can be played simultaneously
 - Supports periodic backup (self-executable footage)
 - Search for and play the data for each event stored in the storage device
- Google Map Viewer
 - View Image through Inter-operation with Google Maps function
- Configuration Manager
 - User login and restrictions according to privilege
 - Equipment registration and allocation
 - Layout setting and allocation
 - Scheduled backup setting
 - Schedule setting
 - Easy guide
 - Device configuration file
 - SSM configuration file
 - Recording Server Schedule Setting
- Console setting
 - SSM console local setting
 - Screen and event local setting
- Updating
 - Supports remote updating of software using update server

TERMS FREQUENTLY USED

- Tree : Display area that shows a list of registered objects and their hierarchy.
- Context Menu : Pop-up menus that appears when right mouse button is clicked.
- Device : Includes DVR, NVR, Video Server, and Network Camera.
- Tile : Unit screen cell that displays video.
- Object : Object is an overall term for the device, camera, site, layout, sensor, etc.
- SSM : Abbreviation of Smart Security Manager.

installation

INSTALLATION

Before Starting

Setting SSM Password

The user inputs the password when installing SSM (recording Server) or registering the recording server in SSM. The password is used for authentication to register the recording server in SSM and can be changed.

[Mandatory]

- The ID and password should not be the same.
- The password should be at least 8 digits and at most 32 digits.
- If the password is smaller than 10 digits but at least 8 digits, it should be a combination of letters, numbers and special characters (no limitation on special characters).
- If the password is 10 digits or more, it should be combination of letters and number at the minimum.
- 4 or more contiguous characters cannot be used. (ex. abcd or dcba).
- 4 or more repeated characters cannot be used (ex. 1111, qqqq)
- A password that violates the mandatory criteria cannot be set.
- The user inputs the password twice, and the password is set only when two inputs are identical.
- The password is used for authentication to register the recording server in SSM and can be changed in Service Manager after the installation.

Installing the SSM

Run the Smart Security Manager installer program on a local PC to install the Smart Security Manager. Software installation requires about 20 minutes, depending on installation conditions.

1. Use provided CD or download and run Smart Security Manager installer, "**SSM_vx.xx_xxxxxx.exe**".
2. When the installation screen appears, click [**Next >**] button.

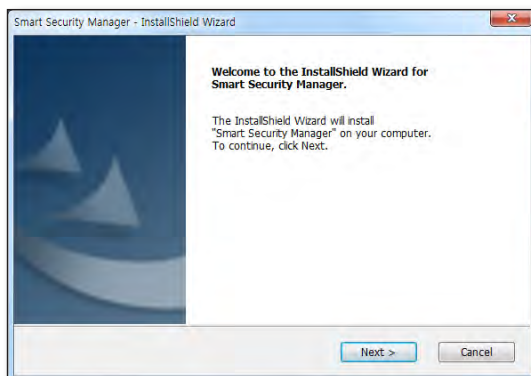

3. Check license agreement and then click **[Next >]** button to proceed to the next step.

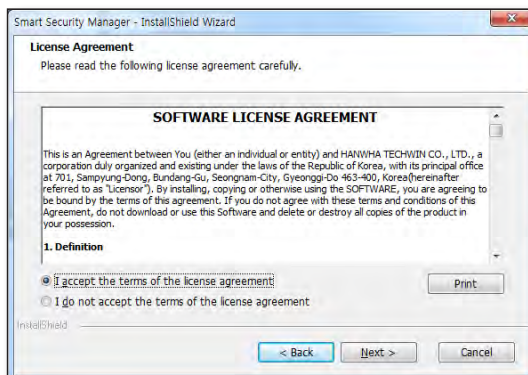

4. Choose whether to install all or partial components.
 - Install all features in this computer (Standalone) : System Manager, Console and Media Gateway are installed on a single computer.

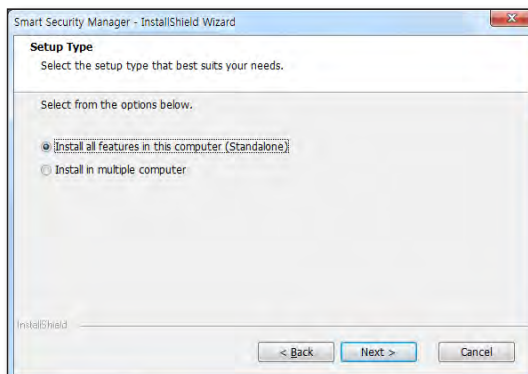

installation

- Install in multiple computer : Installs only selected components of System Manager / Console / Media Gateway onto the PC.



- For information on complete structure according to the installation type, refer to "**Smart Security Manager Structure Overview**". (Page 5)

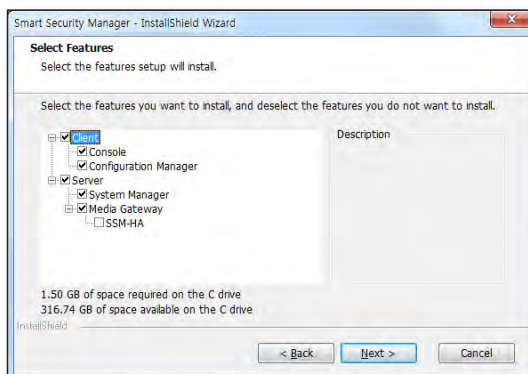

5. Specify the folder path to save the installation program. By default, it is set to "**C:\Program Files\Wisenet**".
 - To change the path, click [**Change...**] button and enter the desired path directly or browse to select one.
6. To proceed to the next step, click [**Next >**] button.

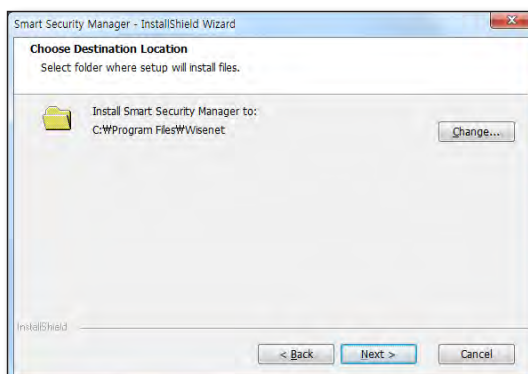

7. Click [**Install**] button to begin installation.

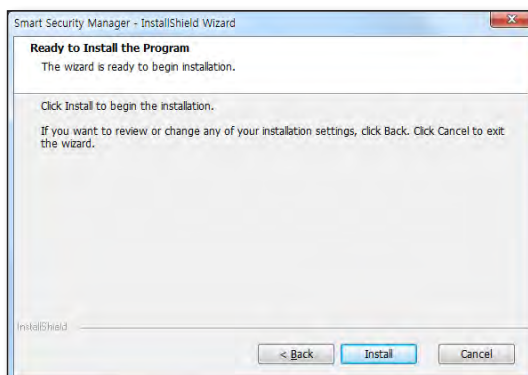

8. Smart Security Manager begins its installation.

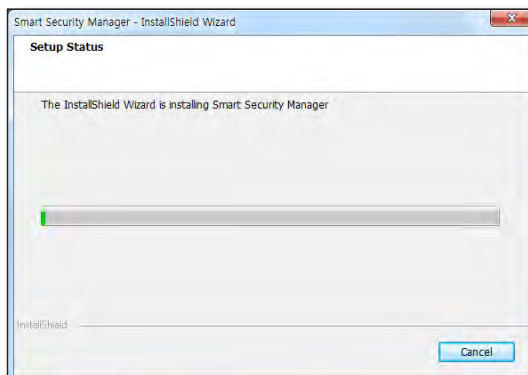

9. When prompted with .NET Framework license agreement, agree and proceed to the next step.

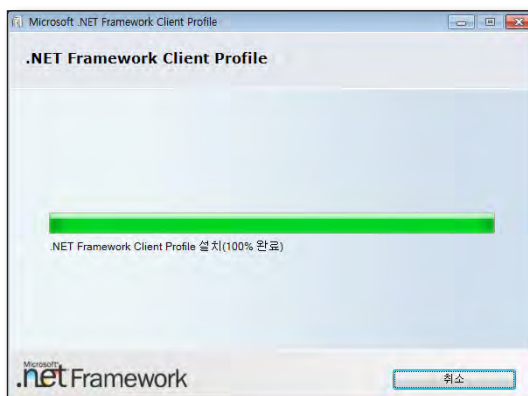

10. DirectX installation package, agree to the license agreement and click [Next >] when prompted with license agreement.

11. Upon completion of DirectX installation, click [Finish] to proceed.

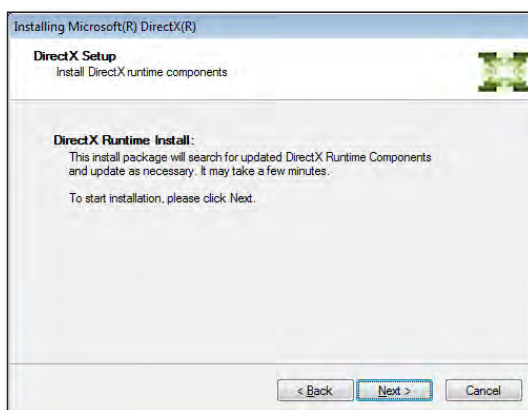

installation

12. Install PostgreSQL.

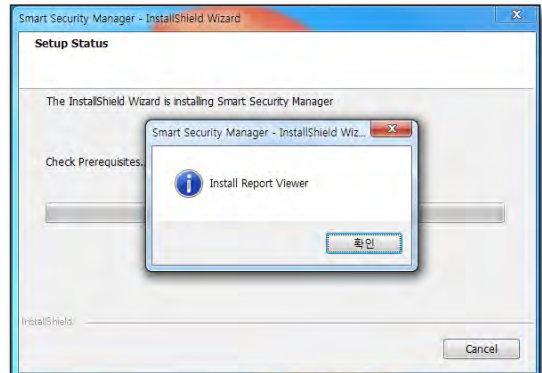

13. Enter the initial password for PostgreSQL.

- For more information about how to set the password, refer to the "Setting SSM Password" section. (page 10).

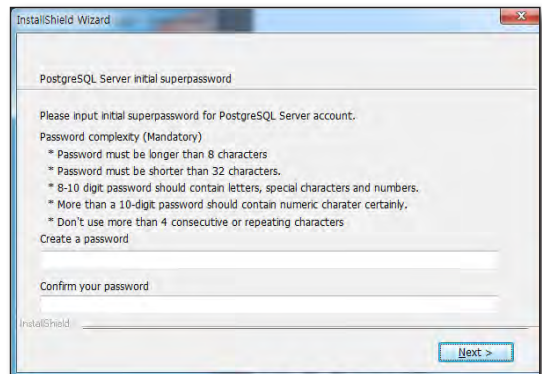

- ## 14. Continue the PostgreSQL installation.
- When installation is complete, the SSM administrator password input window is displayed.

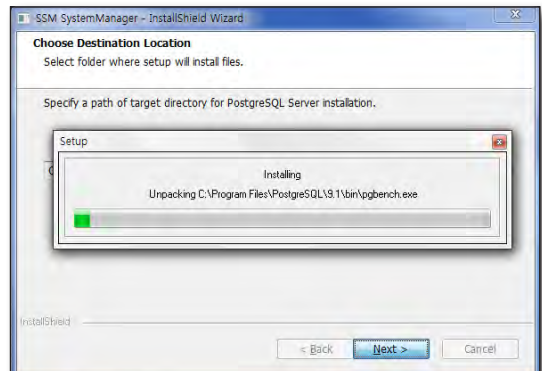

15. Enter the password.

- 
 For more information about how to set the password, refer to the "Setting SSM Password" section. (page 10).

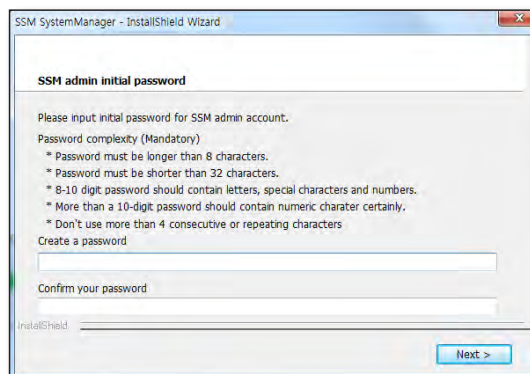

16. The HA installation process is displayed. Select an installation type and click the [Next >] button to proceed to the next step.

- Complete selected : All programs are installed.
- Custom selected : The user can custom select only the programs to be installed.

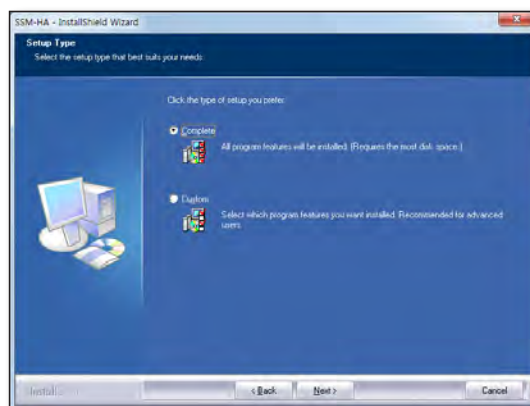

17. Enter the initial SSM-HA password.

Click the [Next >] button to proceed to the next step.

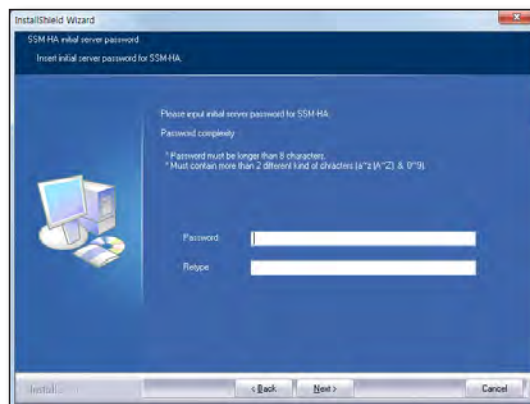

installation

18. Upon completion, click **[Finish]** button.

- If installed with required prerequisites, no further installation popup will appear.

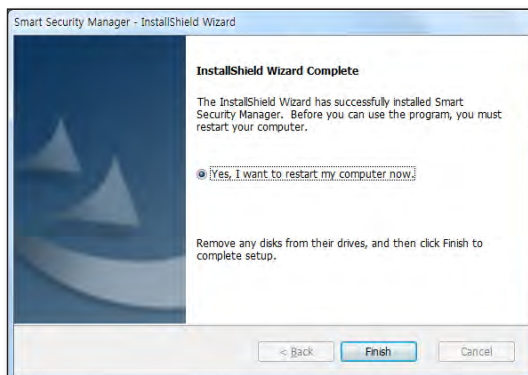

Updating

If Smart Security Manager is already installed, you may update the application by running the update program to the latest version.

1. Run the update installer "**SSM_vx.xx_xxxxxx.exe**". The Update dialog should appear.
2. Click **[Next >]** button to proceed.

- After updating the software application, restart the PC.

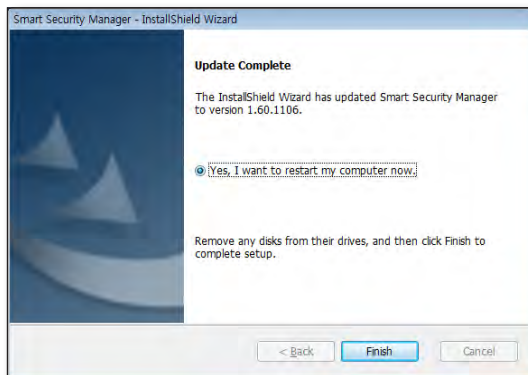

Installing the SSM Recording Server

1. Run SETUP.EXE the Recording Server installation program included in the DVD or user's PC.
2. Click the **[Next >]** button to move to the license agreement step.

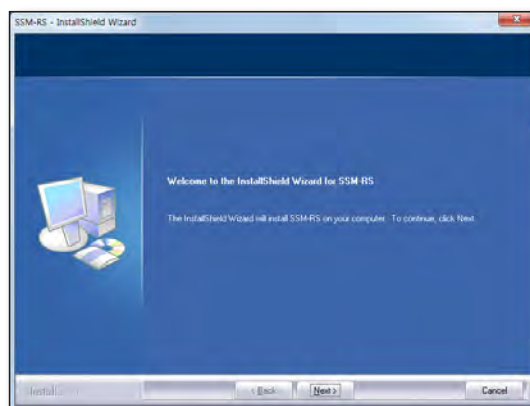

3. If .NET Framework 4.0 is not installed on the user's PC, installation of .NET Framework 4.0 will begin.
 - If NET Framework 4.0 is not installed the Recording Server will not operate properly.
 - .NET Framework can be downloaded and installed at the MS download center.

① In the A NET Framework S/W installation window click on the **[I have read and accept the license terms.]** button.

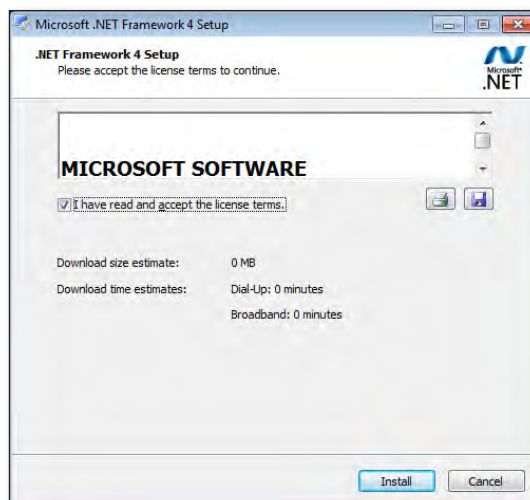

installation

- ② The installation indicator will be displayed in the window while NET Framework is being installed.
 - After finishing installing - .NET Framework 4.0, you can restart the system depending on the PC conditions.

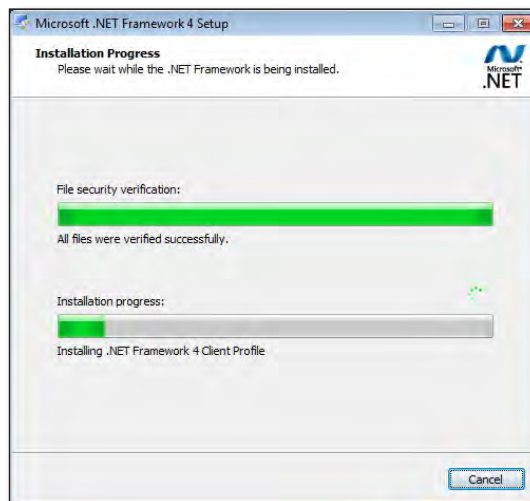

4. Installation of Sentinel Runtime begins when the dongle key driver is not installed in the user PC.
 - The recording server does not run properly if Sentinel Runtime is not installed.
 - The Sentinel Runtime Installation program can be downloaded from <http://www.safenet-inc.com> for installation.

① Click the **[Next >]** button in Sentinel Runtime Installation.

5. Select a SSM-RS configuration type and click the **[Next >]** button to proceed to the next step.
 - You can decide whether to install HA by selecting 'Custom' installation.

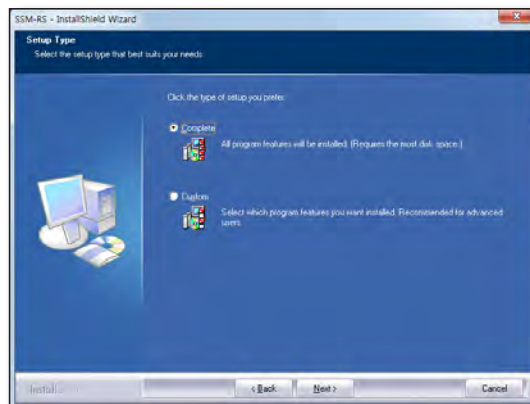

6. Input the initial SSM-RS password.
Click the **[Next >]** button to proceed to the next step.

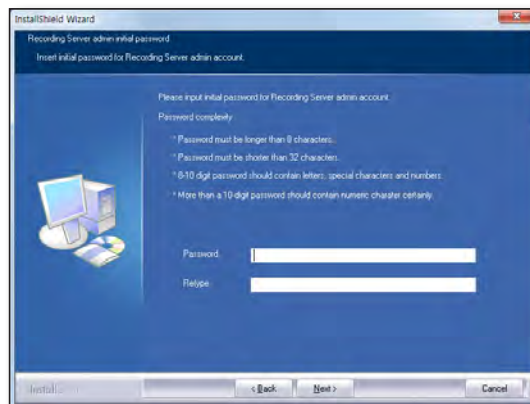

7. Click the <OK> button in the "Install HA program" dialog box to install the HA program.
 - HA Server and Client can be selectively installed during the HA installation step.

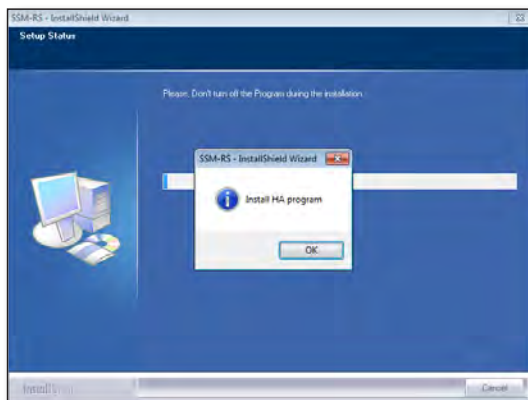

8. The HA program installation begins.

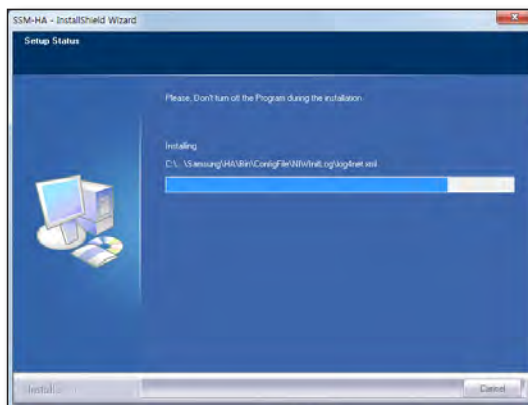

9. The completion confirmation dialog box is displayed after the HA program is successfully installed. Click the <OK> button.

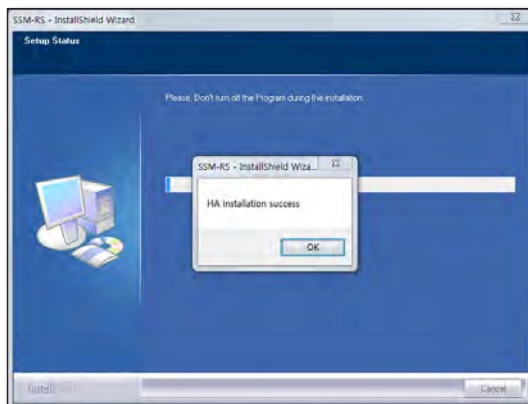

installation

10. Preparing to install the Recording Server.

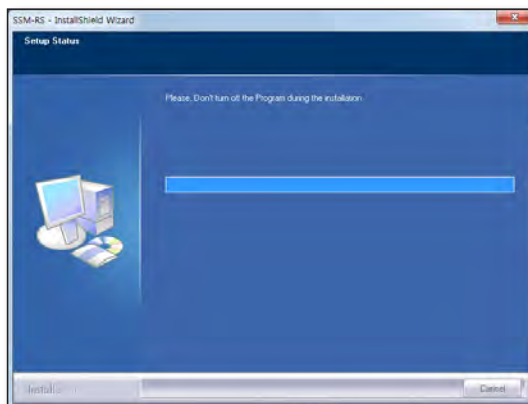

11. When the installation has finished successfully, click on the **[Finish]** button to terminate.

- After installation is finished, the PC will restart.

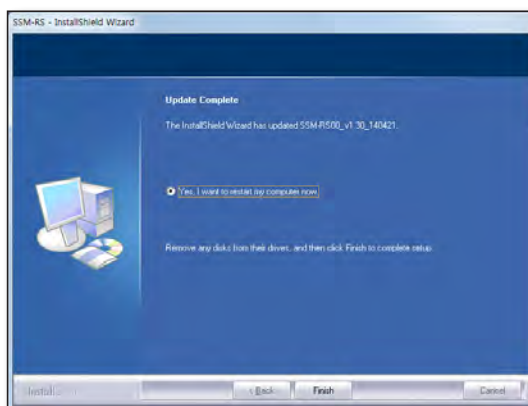

Upgrade

If the Recording Server is already installed on the PC. You can run the upgraded program file or use Update Manager to perform upgrades.

Click the **<Yes>** button to maintain the existing database during updating.

- After updating software applications, restart the PC to prevent malfunctions.

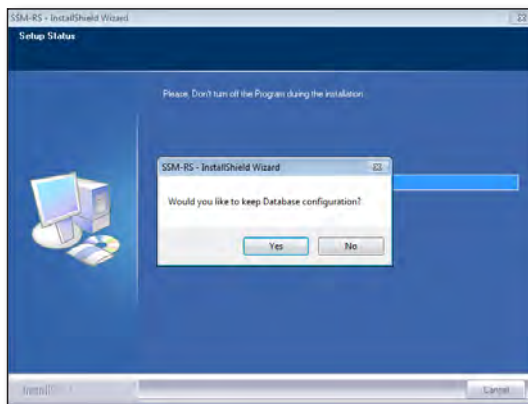

getting started

CHECKING INSTALLED INSTALLATION

SSM

Check whether the Smart Security Manager installation has been successfully installed.

1. Click <Start> Windows menu.
2. When Smart Security Manager is properly installed, you can see the <HA>, <License Manager> and <Recording Server> items in the Wisenet submenu.

You can find the <License Manager> item in the <License Manager> submenu.

In the Recording Server submenu, you can find the <Service Manager> and <Uninstall> items.

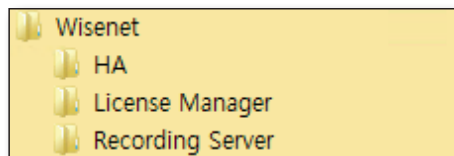

- For distributed installation, only those menu items selected in installation will appear. Refer to the "Installation" section. (Page 10)

Recording Server

After finishing the installation, check if the Recording Server is installed properly.

1. Click <Start> Windows menu.
2. If the Recording Server is installed properly, you will see the 2 items, <ServiceManager> and <Uninstall> below the Recording Server.
 - When you run the program for the first time, the language for the Recording Server is automatically set to the OS language.

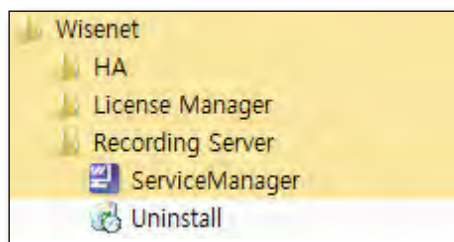

HA

Check if HA Manager was successfully installed after the installation is completed.

1. Move to the <Start> menu.
2. If HA is successfully installed, <HA Manager>, <HA Server Configuration> sub folder is displayed under the 'HA' folder.

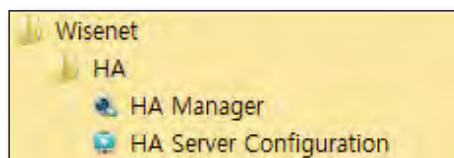

getting started

GETTING STARTED WITH SMART SECURITY MANAGER

In case of Standalone installation

1. Click <SSM Service Manager> shortcut icon or expand and click "Start > Wisenet > SSM > SSM Service Manager".

- SSM Service Manager : A software program that manages server software products. To use SSM Console, the server should be ready.



2. Double click <SSM Service Manager> icon on the task tray or click right mouse button on it to open context menu and click <View Service Status>.

3. Click <Start Service> button.

If successfully installed, each installed program component should show its <Service Status> as <Started>.

4. Run the SSM Configuration Manager to utilize the SSM Console program after the initial installation.



- If the program is already set, Start SSM Console right away.

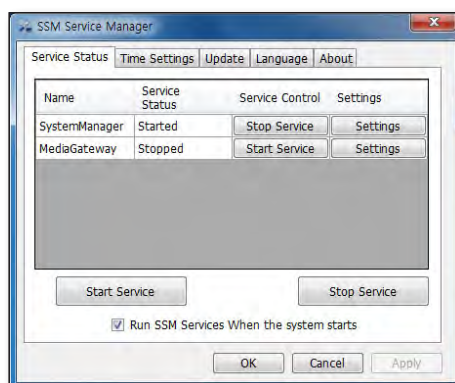

In case of multi installation

A Media Gateway server computer can connect to only 1 System Manager. A System Manager accepts connections from multiple Media Gateway servers. A System Manager accepts connections from multiple Console clients.

1. Run the Service Manager on the computer installed with the System Manager. (Page 195)

2. Click <Start Service> button.

- If successfully installed, the System Manager should show its <Status> as <Started>.

3. Run the Service Manager on the computer installed with the Media Gateway. (Page 195)

4. Run the Service Manager on the computer installed with the Media Gateway and click <Start Service> button.

- If successfully installed, the Media Gateway should show its <Status> as <Started>.

5. Run the SSM Configuration Manager to utilize the SSM Console program after the initial installation.



- If the program is already set, Start SSM Console right away.

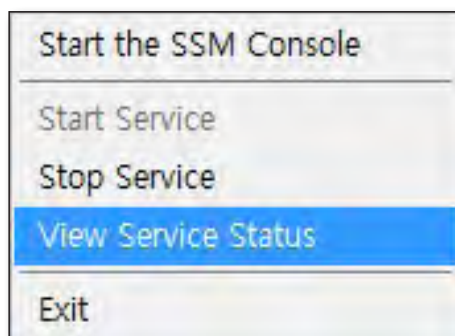

USING SSM LICENSE MANAGER

The program manages the licenses of all SSM products.

SSM License Manager supports activation, deletion and transfer of SW licenses.

It also supports the license activation of the HW dongle key used by SSM-RS and SSM-VM v1.0.

License Type

The SW license and HW dongle key license are supported.

- SW license : Supported by SSM v1.3 or higher
- HW dongle key license : License used by SSM-RS and SSM-VM v1.0 to maintain backward compatibility
 - If the SSM-RS v1.0 promotion (16ch) is used, the license activation is not needed when the update is installed.

License Activation

Online SW Activation

The online SW activation menu allows the user to activate the license if the user can access the EMS server (license server) through a Web page.

Procedure

1. Select the [**Online SW Activation**] menu of License Manager.
2. Input the product key and click the [**Activation**] button.
 - 3 messages are displayed when the license is activated.

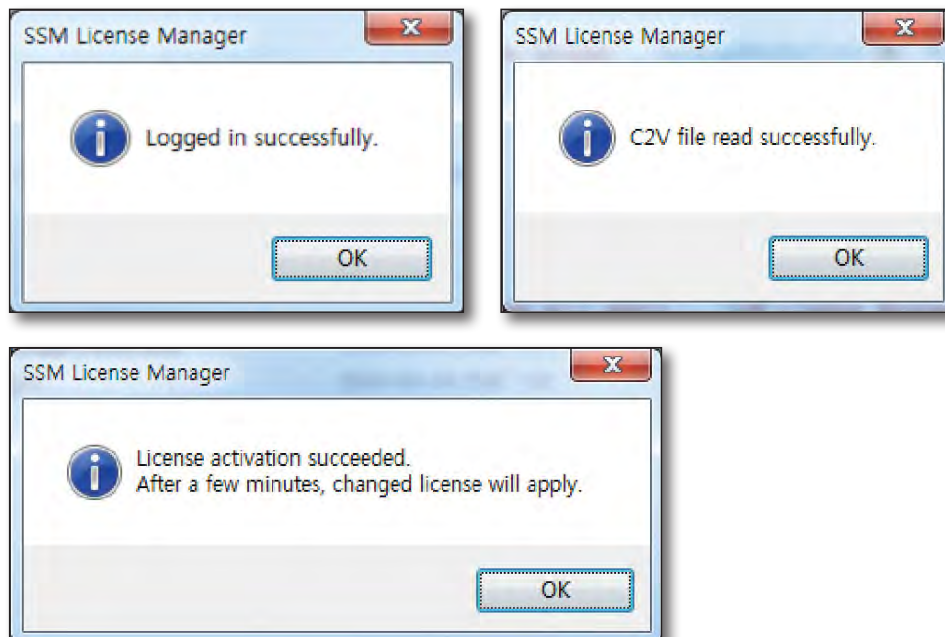

getting started

License Server Data

<https://ems.samsungsecurity.com/ems/customerLogin.html>

Cases of Failed License Activation

1. When a 'Trust Failure' pops up while a user is verifying a license online: Please check the time and the system will synchronize the Internet time. (Server : time.windows.com)
2. Failed login to the license server online: Check if Internet is connected.
3. Attempt to authenticate the license of already authenticated product key: Check if the license key was already authenticated. An authenticated license key cannot be authenticated again.
4. Terminated license module service: Check if the ACC page can be accessed.
If not, check if the Sentinel LDK License Manager service in the service menus is stopped and start the service.
 - ACC page : <http://localhost:1947>

Offline SW Activation

Offline SW activation allows the user to activate the license when the user cannot access the EMS server (license server) through the Web page.

Create a C2V file in the PC to authenticate the license and create a V2C file in the PC that has access to the license server then authenticate the license.

Procedure

1. Select [**Offline SW Activation**] in the License Manager.
2. Click the [**Collect information**] button in the Collect Status Information menu to collect the PC data to activate the license.
 - Create a C2V file with the [**Collect Information**] button (to collect the PC data to authenticate the license).
3. Connect to the license server Web page (EMS) from a PC that has online access to the license server.
 - Address : <https://ems.samsungsecurity.com/ems/customerLogin.html>
4. Log in with the product key provided.
5. Click the [**Register Later**] button in the upper right corner.

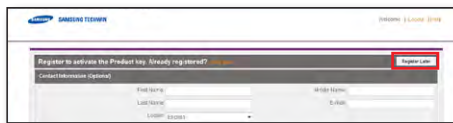

6. Click the [**Offline Activation**] button in the upper right corner.



7. In the Generate License popup dialog box, upload the C2V file run in Step 1 and click the **[Generate]** button. Download the generated V2C file.

- Create a V2C file (license file) using the C2V file containing the collected PC data.

8. Retrieve the downloaded V2C file from **[Apply License File]** of the **[Offline SW Activation]** menu of the License Manager. Then click 'Apply Update' to register the license in the PC.

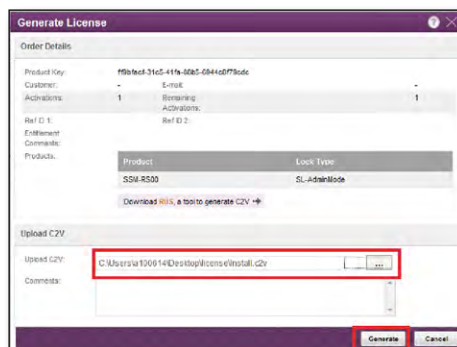

HW Dongle Activation

This section describes the activation of HW dongle key license.

- HW dongle key : A license key supported by SSM-RS and SSM-VM v1.0

Run **[HW Dongle Activation]** menu of the License Manager.

To activate a HW license, the current service must be stopped before the license is activated.

After the HW license is activated, the use must restart the service manually.

Procedure

1. Stop service of the product to activate the license.
2. Select the **[HW Dongle Activation]** menu in the License Manager.
3. Click the **[Check Hardware license information]** button to check the dongle key information.
4. After checking the HW dongle key information, click the **[Activation]** button to activate the license.
5. Restart the stopped service.
 - The HW dongle key license cannot be activated remotely.

getting started

License Removal

This function is applicable only to the SW license. The menu is used when a customer demands a refund after purchasing a product.

Upon a demand for a refund, the key ID of the purchased product is sent to the seller to delete the license.

Checking the Product Key ID

Select the feature of the key in Options > Products in the left hand side of the ACC page.

- ACC page URL: <http://localhost:1947/>

Procedure

1. Send the product key ID to the licenser server administrator and request the removal of the license. Send the license key data issued upon the demand for refund. (Refer to the product key ID checking.)
2. Delete the license using the V2C file (license removal file) received from the license server (EMS). It is run in [1] of the [Remove SW license] menu of the License Manager.
 - When the V2C file (license removal file) is updated, the product information of the product is deleted.
3. Create a C2V file to confirm that the license was successfully deleted. Click the [Collect information] button in [2] of the [Remove SW license] menu of the License Manager.
 - If there are multiple authenticated licenses, a license list popup window is displayed. Select the deleted product key and create the C2V file of the selected key.
 - If only one license was authenticated, the license list popup window is not displayed, and the C2V file of the deleted product key is automatically created.
4. Send the created C2V file to the license administrator.

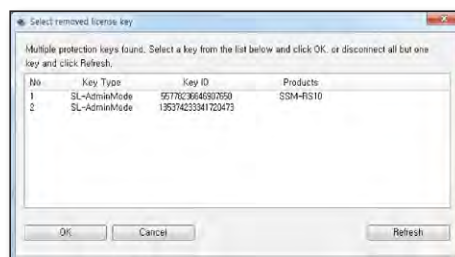

License Transfer

This menu is used to transfer the license due to the PC problem or upgrade.

- Source PC : PC of the authenticated license
- Recipient PC : PC to receive the new license

Procedure

1. Create the ID file to collect the PC data in the recipient PC.
Run [1] in the [**Transfer license**] menu of the License Manager.
 2. Create a transfer license file in the source PC.
Run [2] in the [**Transfer license**] menu of the License Manager.
 1. Configure the ID file created in the recipient PC in the 'Read the recipient information file'.
 2. Configure the name of the transfer license file.
 3. Select the license key to transfer from the license list.
 4. Click the [**Generate License Transfer File**] button to create a transfer license file (H2H file).
 - When a license key is transferred, the license key to be transferred is removed from the list.
 3. Apply the transfer license file (H2H file) to the recipient PC.
 - The transferred license key can be checked in the license list after the H2H file is uploaded.
 - The transferred license can be checked in the ACC page also.
-  **Caution when Using the SW License**
- The license activation is not needed after upgrading or re-installation after removal.
The license exists in the PC until the hard disk is formatted.
 - Transfer the license to a new PC first when replacing a PC.
 - When OS is reinstalled (after HDD format), transfer the license to another PC temporarily and then retrieve it.
 - Actual PC instead of VMWare is recommended.
The SW license may not run properly in VMWare (ex., after duplication of VMWare).

SSM configuration manager

This function is used to register the SSM console users and devices, configure the screen layout, and set up the schedule and backups.

Use <**Standard Setup**> to set up the whole system, or <**Easy Guide**> to setup only the basic guide for monitoring.

LOGIN/LOGOUT

Login

SSM Configuration Manager requires the user to log in after the program is started for normal operation.

1. Click the SSM Configuration Manager icon.
The login authentication window is displayed.
2. Enter the user ID and password in the login window.
 - Default ID: admin
 - Password: Enter the password registered during the installation step.



- If the SSM is installed in distributed mode and you need to start a program installed in another server, click the [] button located below the login button in the login window to register the server to either <**Auto**>, <**Manual**> or <**DDNS**>.
- If it is set to <**Auto**>, SystemManager is automatically selected. If it is set to <**Manual**>, System Manager can be selected from the list, or IP address and Port information can be set.
- If it is set to <**DDNS**>, then the DDNS input field will be activated.

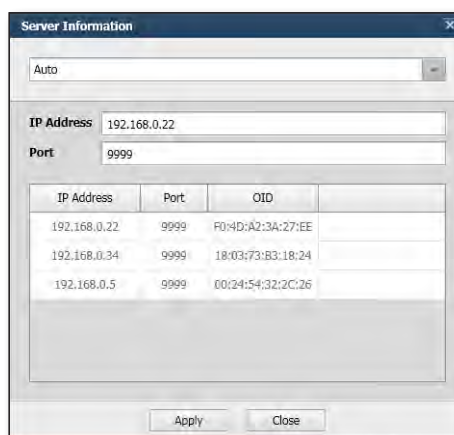

3. The selection menu is displayed when the program is started for the first time.
Select a menu option according to the desired configuration.
 - After the initial run, the program will be started in <**Standard Setup**> mode.



Easy Guide

This only shows the minimum menu options needed for monitoring, such as device registration and allocation.

Only device, user group, user, and site registration and allocation are enabled in this mode.

When a device is registered, it is automatically assigned to a site and user group separately by EasyGuide.

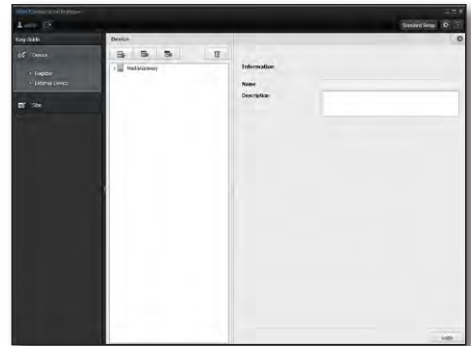

Standard Setup

All functions of Configuration Manager can be set up.

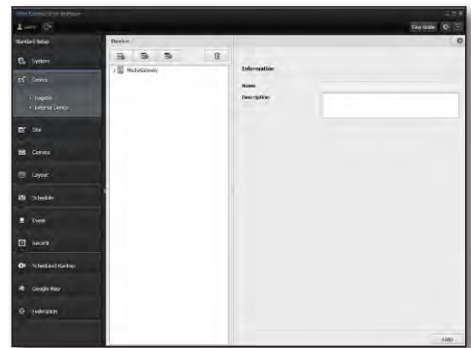

SSM configuration manager

SYSTEM SETTINGS

User

This function is used to generate the user group, set up the privilege of each user group, and add users to the group.

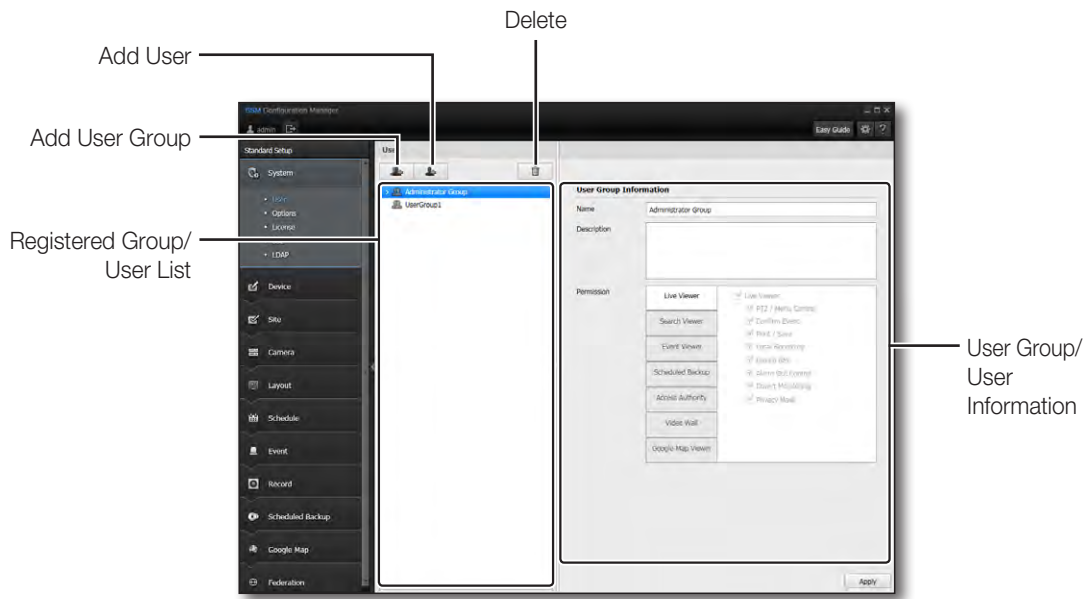

Setting a User Group

To add a User Group

1. Click the [] button.
2. After a user group is generated, enter the name and description in the info field on the right hand side and configure the privilege.
3. When done, click [Apply] button.

- ! The default "**Administrator Group**" is created in program installation process, which is not to be deleted.

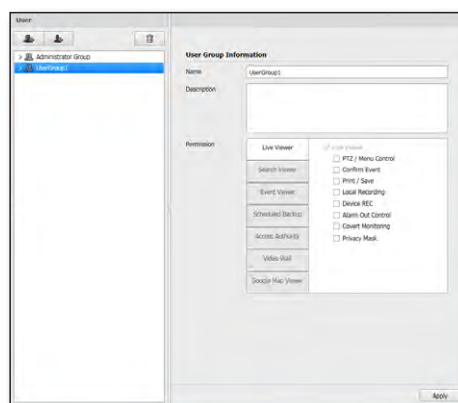

To edit User Group privilege

1. Select a user group under a site from the tree.
2. Edit the user group's information on the right pane.
3. Select allowed privileges by checking checkboxes.
 - Live Viewer : Privileges can be set for each item selected to the Live page.
 - Search Viewer : Privileges can be set for each time selected to the Search page.
 - Event Viewer : Privileges can be set to the generated event.
 - Schedule Backup : Schedule backup privileges can be set.
 - Access Privilege : Accessible setting menu can be selected and set. The users in a group can access only the set menu.
 - Video Wall : Video wall privileges can be set.
 - Google Map Viewer : Sets the Google Map Viewer authority.

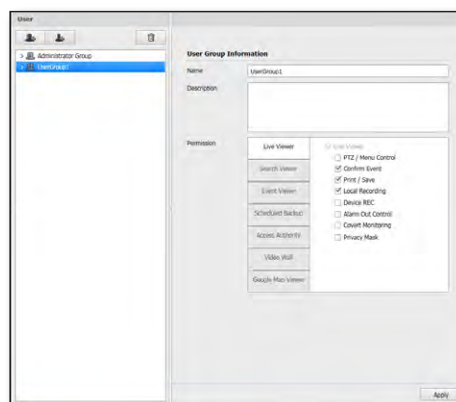

- ! For "Administrator Group", changing privilege is not allowed.
- Setting privilege is only available in user group information.
- Live Viewer is allowed by default, and cannot be disallowed.

4. When done, click [Apply] button.

To delete a User Group

Select a user group to be deleted, and click [] button.

SSM configuration manager

To add a User

1. Select a user group from the tree.
2. Click the [] button.
3. Enter the user information.
4. When done, click **[Register]** button.

- ! ■ The default **"admin"** account is created in program installation process, which is not to be deleted.
- When setting a password, if the password does not satisfy the basic criteria, another password satisfying the criteria must be input again.

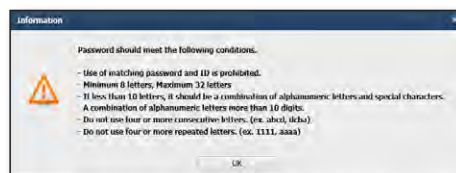
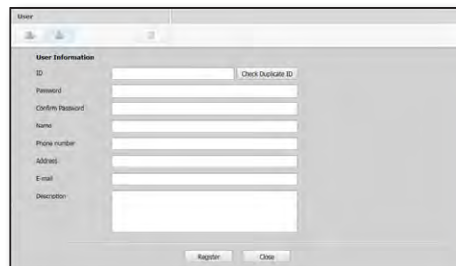

To edit user

1. Select a user from a user group in the tree.
2. Edit user ID, password, name and other fields on the right pane.
3. When done, click **[Apply]** button.

- ! ■ The **"Administrator Group"** has all privileges, and users in the **"Administrator Group"** are allowed with all privileges accordingly.

To delete a user

You can select users registered to a group to delete. Select a user to be deleted, and click [] button.

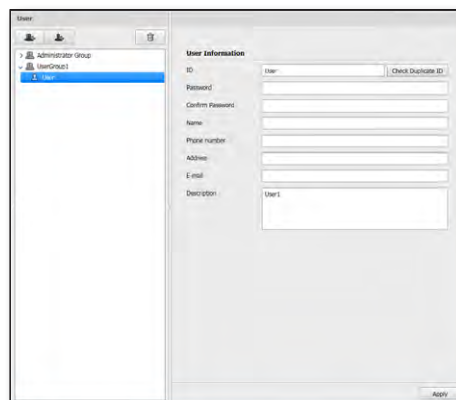

Option

You can configure and manage all settings for the system items.

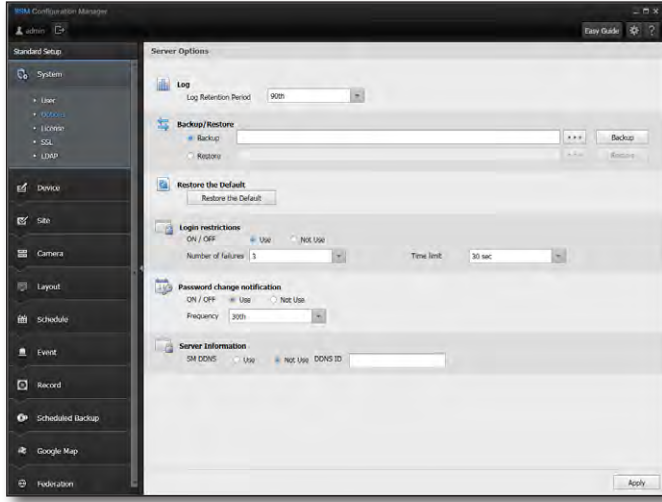

To Set up Option

1. Configure each option item.

- Log
You can set the log retention period, which sets to delete expired log files automatically.
- Backup/Restore
You can back up the current settings or restore the SSM Configuration Manager setups from a saved file.
 - Backup : Selecting this item disables the button. Set the backup file path and click [**Backup**] button to start backup into the specified file path.
 - Restore : Selecting this item disables the button. Set the restoration file path and click [**Restore**] button to load setup from the specified backup file.
- Restore the Default
Initializes SSM Configuration Manager program's setup to the default settings.
- Login Restrictions
Login restrictions can be specified.
 - Number of Failures : Login is restricted when the specified number of login attempts is exceeded.
 - Time Limit : Login is restricted for a specified time after a login failure.

SSM configuration manager

- Password Change Notification
Password change notification can be sent.
After it is turned **<Use>**, the notice is sent at the interval specified in **<Frequency>**.
- Server Information
 - SM DDNS Use/Not Use : This option specifies whether the DDNS login function will be used by the system manager in Mobile Viewer and Web Studio.
 - DDNS ID : Enter the ID to be used for DDNS login.

2. When done, click **[Apply]** button.

License

You can view the registered license information.

- A license is displayed for each module in the SSM.
(SSM, SSM-RS, SSM-MG, SSM-TS)

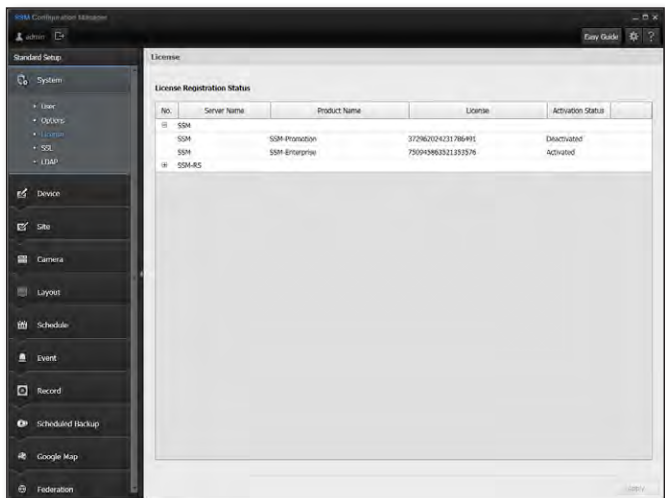

The screenshot shows the SSM Configuration Manager interface. On the left is a navigation menu with categories like System, Device, Site, Camera, Layout, Schedule, Event, Record, Scheduled Backup, Google Map, and Federation. The main area displays the 'License Registration Status' table.

No.	Server Name	Product Name	License	Activation Status
1	SSM	SSM-Production	37296202431786491	Deactivated
2	SSM	SSM-Enterprise	73094286321332576	Activated
3	SSM-RS			

SSL

You can select a secure access method or install a certificate.

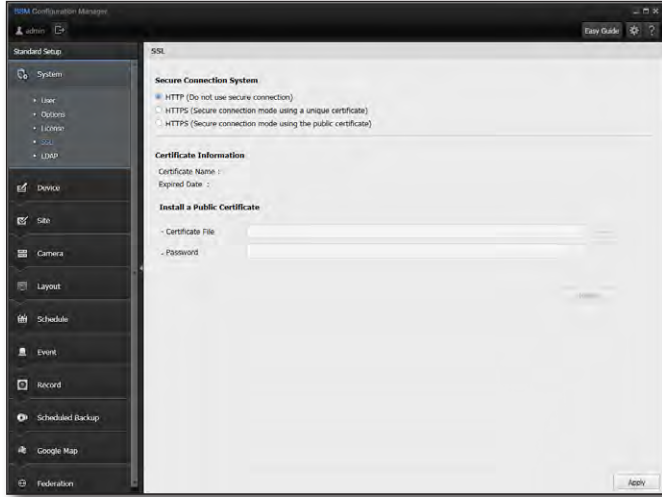

1. Select a secure access method.
2. Search and register a certificate to install.
3. After completing the configuration, click the **[Apply]** button.

To install a certificate

1. Select **<HTTPS (Secure connection mode using the public certificate)>** and click the [...] button to choose a certificate to install.
2. Input the password for the certificate and click the **[Install]** button.
 - After installing the certificate, the **[Install]** button will be changed to the **[Delete]** button.

SSM configuration manager

LDAP

Adds and deletes an LDAP server.

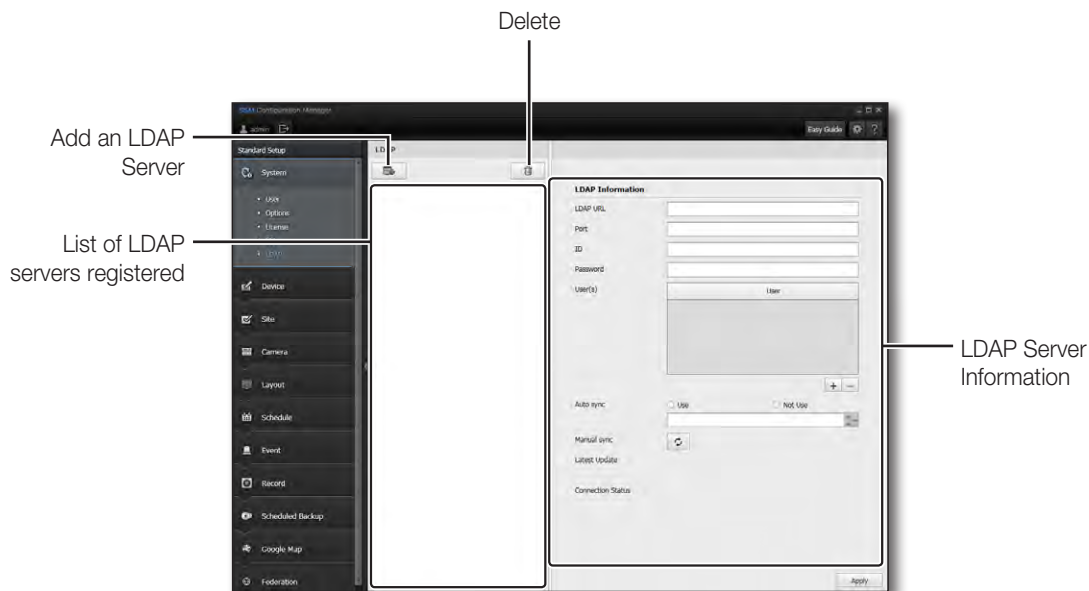

Configure LDAP Server Settings

To add an LDAP server

1. Click the [] button.
2. When the LDAP Information Window is launched, input the URL, access port, access ID, password and information of the user (LDAP) to be added in the information input fields.
 - When the synchronization is completed after registering an LDAP, the SSM user menu is displayed to the corresponding user.
3. Select or deselect the Auto Synchronization check box and set the synchronization time.
4. After completing the settings, click the [Register] button.
 - The number of LDAP registrations is limited to 1.

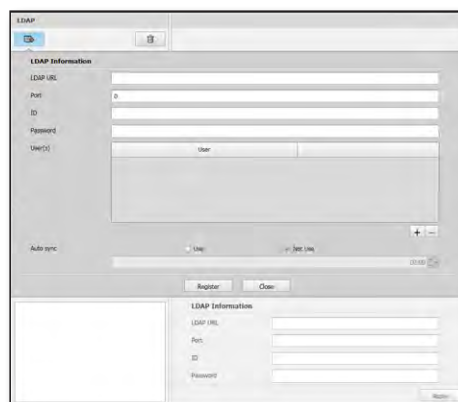

View LDAP Information

You can view the LDAP information when you select the LDAP server added.

To modify the LDAP server information

1. Select the LDAP server added.
2. On the LDAP Information window, input the information in the field you want to modify.
3. After completing the modification of information, click the [Apply] button.

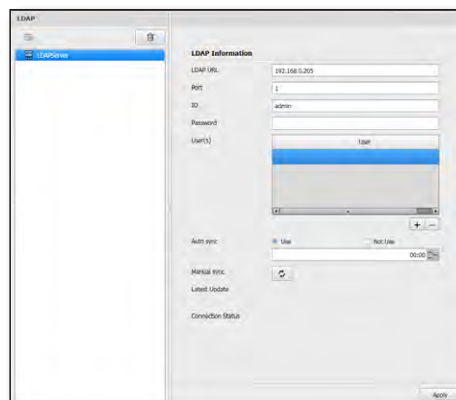

To delete the LDAP information

1. You can select and delete a desired LDAP that is registered.
2. Select an LDAP and click the [] button.

OPTION SETUP

To Set up Option

1. Click the [] button at the upper-right section of the SSM Configuration Manager screen.
 - Language
Display language can be specified.
 - Use Device's Default Name
When it is checked, the name of the camera registered to the device is displayed in the list or the screen.
2. When done, click [Apply] button.

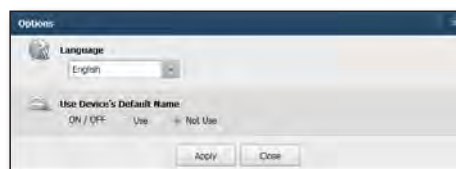

SSM configuration manager

DEVICE

Register

You can register the Media Gateway and the Recording Server and a device below it.
This lists the devices registered by the user.

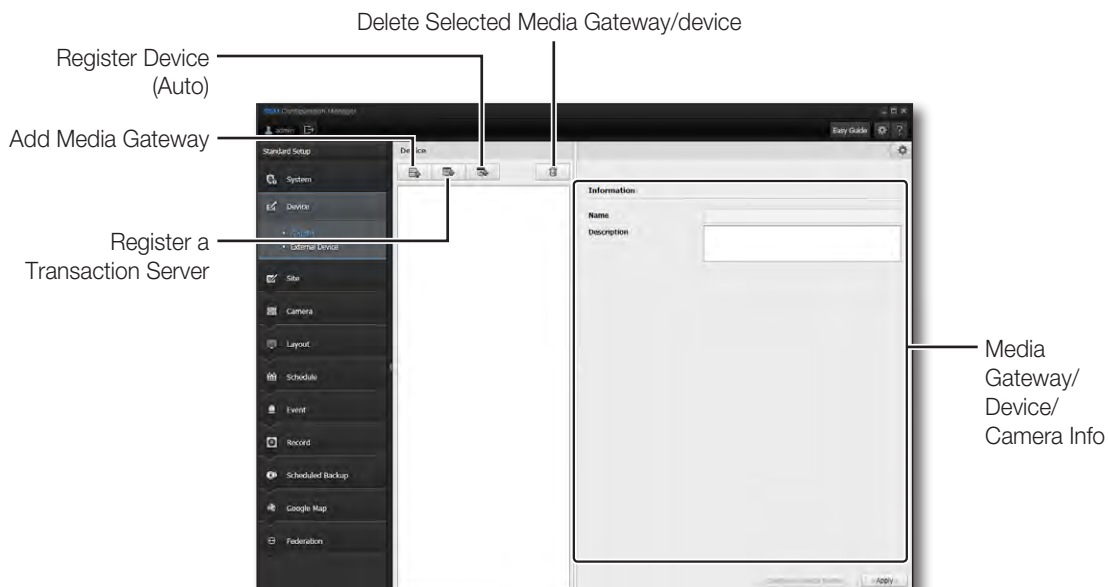

A device can be added when **<MediaGateway>** is selected in the tree menu.



- A media gateway is a server which is connected to the camera, DVR, encoder or recording server to manage and relay the devices. Since the console communicates with the devices through the media gateway without being directly connected to the device, the media gateway must be selected first before the registration of devices.
 - The protocol supported in SSM are SUNAPI, SVNP and ONVIF.

Setting the Media Gateway for Standalone Installation

To add a Media Gateway

1. Click [] button in device setup page.
2. Select a desired Media Gateway from the list and click [Register] button.
 - If Media Gateway IP address is displayed as 0.0.0.0, be sure to check your PC's network settings.
3. If no MG information to register is displayed on the list, click the [] button and input the IP address and port manually.
4. To finish registration and close the window, click [Close] button.

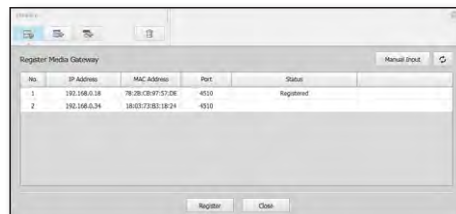

To edit Media Gateway information

The right pane shows information on the Media Gateway selected from the tree menu, which is available to edit.

1. Click on a desired Media Gateway to be edited.
 2. Edit name and description of the selected Media Gateway.
 - DDNS Use/Not Use : This is the setting used to remotely access the media gateway. Input the DDNS ID if the DDNS is used and IP (WAN) address if not.
 - IP (WAN) : Enter IP (WAN) generated for each media gateway.
-  IP address, MAC Address, and port number are for display only and cannot be modified.
- Refer to 'Option' for details of setting the DDNS of the System Manager. (Page 33)
 - Transcoder Not Use/Use : By activating the Transcoder, you can reduce the CPU memory usage.

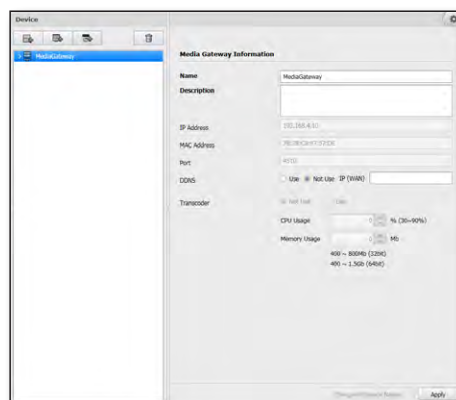

To delete a Media Gateway



Select a Media Gateway to be deleted, and click [] button.

SSM configuration manager

Setting the Media Gateway for Distributed Installation



1. Run the Service Manager on the computer installed with the System Manager. (Page 195)
2. Run the Service Manager on the computer installed with the Media Gateway. (Page 195)
3. On the Media Gateway server, set the IP address and port number of computer installed with the System Manager.

To add a Media Gateway

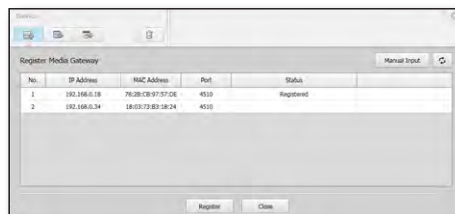
1. Click the [] button in the device setup window.
2. The list of media gateways that can be registered in System Manager that the console accesses will be displayed.
3. Select a desired Media Gateway from the list and click [Register] button.
 - If Media Gateway IP address is displayed as 0.0.0.0, be sure to check your PC's network settings.
4. If no MG information to register is displayed on the list, click the [] button and input the IP address and port manually.
5. To finish registration and close the window, click [Close] button.



To register the transaction server automatically

1. Click the [] button.
2. In the list of servers displayed, select a transaction server and click the [Register] button.
3. If the transaction server to register and its information are not displayed on the list, click the [] button and input the IP address and port manually.
4. After completing registration, click the [Close] button to close the window.

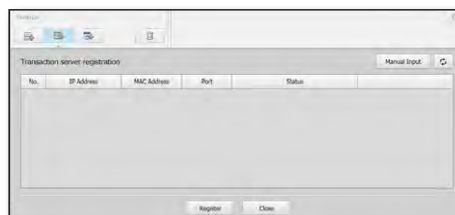

To modify the transaction server information

Select the transaction server from the tree menu, then the information of the selected transaction server is displayed on the right of the screen, where you can modify the information.

1. Click the transaction server you want to change the information.
2. Input the name and descriptions to change.
3. After you finish adding or modifying information, click the **[Apply]** button.
4. If you click the **[Settings Page]** of the transaction server on the information window, the web settings page for the transaction server selected is launched.
5. Change the settings as desired.
6. After you finish configuring settings, click the **[Apply]** button on the settings page and close the window.

To delete a transaction server

You can select and delete a desired transaction server that is registered.

Select a transaction server and click the [] button.

Adding Devices

To add a device automatically

You can search add a device connected to your local network automatically.

1. Click [] button.
All discovered devices or Recording Servers from the local network are shown in the **"Register Device (Auto)"** list.
2. Select a device or Recording Server to register from the list.
 - SVNP or SUNAPI can be registered as the protocol type. When the protocol type is set to SUNAPI, you can search for and register a SUNAPI supported device.
3. Enter the ID and password, and click **[Register]** button.

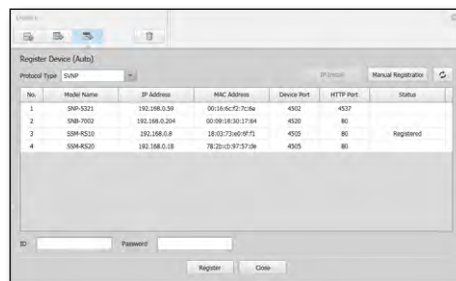

- The User ID and password should be the account registered to the corresponding device.
- If connection encounters error, corresponding message of cause is displayed in the status tab.
- Refer to **"Installation of SSM Recording Server"** for details of password setting.

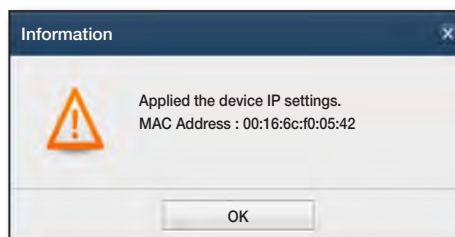

SSM configuration manager

4. Click the **[Register]** button. Once registered, it is marked as "**Registered**" in status tab, and added under the Media Gateway list.
 5. To finish registration and close the window, click **[Close]** button.
- IP Install : The device network can be configured.
Input the network data to change. If the device password matches, the network data of the device can be changed.



If you want to add a camera to the Recording Server

You can automatically search for a camera registered in the Recording Server.

1. From the device list, select a Recording Server to register a camera for.
2. Click on the [] button.
 - <Wisenet> or <ONVIF> can be selected when registering a camera in the recording server. When <Wisenet> is selected, either SVN or SUNAPI can be registered as the protocol type.
 - If the vendor is set to <ONVIF> when registering a camera of the recording server, the <ONVIF> cameras can be searched and registered.
 - The registration for the ONVIF model only supports the SSM-RS10, SSM-RS20 and SSM-RS30 products.
 - If the vendor is set to <Wisenet> and the protocol type to <SUNAPI> when registering a camera of the recording server, the cameras supporting SUNAPI can be searched and registered.
3. Select a camera to register from the list of cameras.
4. Enter a user ID/password and click on the **[Register]** button.
 -  ▪ User ID and password are the ones saved in a camera that you want to register.
 - If connection problems are encountered, a corresponding message of the cause will be displayed in the status tab.
5. Once registered, it is marked as "**Registered**" in status tab, and added in the sub list of the Recording Server in the tree menu.
6. To finish registration and close the window, click **[Close]** button.

To add device manually

Device can be registered manually by a user, by directly entering required information.

1. Click [**Manual Registration**] button.
"Register Device (Manual)" window should appear.
 2. Select the model name for a device or Recording Server that you want to access.
 3. Select the address type.
 - Available types are static IP, URL, S1 DDNS, and Wisenet DDNS.
 - Available address type can be different depending on the device.
 - When selecting a model that can support the SUNAPI protocol at the time of selecting a model to register, a window to select a protocol type is added. When selecting the protocol type SUNAPI added, you can set the media protocol to TCP, UDP, Multicast or HTTP.
 4. Provide required information for connection to the device.
 - Required information is dependant to the set address type.
 5. Enter the ID and password.
 - The User ID and password should be the account registered to the corresponding device.
 6. Click [Register].
 - If connection encounters error, corresponding message of cause is displayed.
-  When a device is registered in Easy Guide mode, the site and administrator group are automatically assigned. In Standard Setup mode, the administrator group is automatically assigned after the device is registered and the site is assigned.

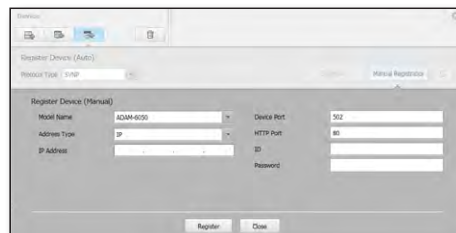

SSM configuration manager

If you want to manually add a camera to the Recording Server

You can directly enter the information of a camera registered in the Recording Server.

1. From the device list, select a Recording Server to register a camera for.
2. Click on the [] button.
3. Select the desired camera's model name.
 - <Wisenet> or <ONVIF> can be selected when registering a camera in the recording server. When <Wisenet> is selected, either SVNP or SUNAPI can be registered as the protocol type.
 - If the vendor is set to <ONVIF> when registering a camera of the recording server, the <ONVIF> cameras can be searched and registered.
 - The registration for the ONVIF model only supports the SSM-RS10, SSM-RS20 and SSM-RS30 products.
 - If the vendor is set to <Wisenet> and the protocol type to <SUNAPI> when registering a camera of the recording server, the cameras supporting SUNAPI can be searched and registered.
4. Select the address type.
 - The available address types are: IP Address, URL, Wisenet DDNS.
 - The available address types may vary depending on the camera model.
 - If a model type that SUNAPI can be registered with is selected in the manual camera registration, a protocol type combo box is output.
5. Set the necessary information for connecting a camera.
 - Different information is required for each address type.
6. Enter user ID and password.
 - User ID and password are the ones saved in the camera that you want to register.
7. Click on the [Register] button.
 - If connection issues are encountered, the corresponding cause message is displayed.

How to set multiple passwords

Additional passwords can be set for systems that can set multiple passwords.

1. Select systems that can set multiple passwords in the device list window.



- When a device is registered, the protocol type should be selected as SUNAPI, and usable systems should be registered.
- Refer to the system specifications to find out whether or not multiple password setting is possible.

2. When a system is selected, an additional password input window pops up.

3. Enter a password to add in the input window.

- It is possible to certify only when all input passwords should coincide with passwords that were set additionally in the system. (If two passwords have been set, it is possible to certify only when two passwords should be entered.)

4. When multiple passwords are correct, recording is possible, and the system can be used during recording and playback.



- Multiple password items are displayed only when the logging is done by a user account.

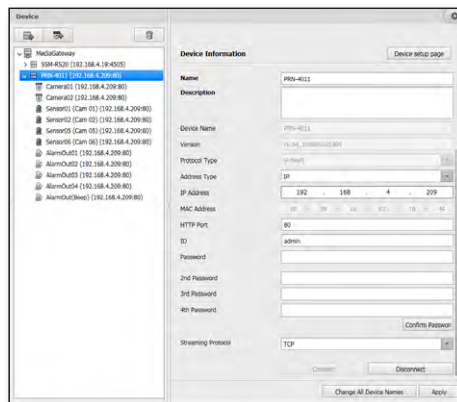

SSM configuration manager

Editing Device Information

You can edit information of a device registered.

To edit device information

1. Select a desired device to be edited.
2. In the right information pane, edit the device information.
3. When finished, click **[Apply]** button.
 - System Restart setting : You can set the period and the execution time to restart the system (PC) periodically.
 - This item is only supported in the RS.
 - Device Connect : Connects to the selected device.
 - Device Disconnect : Ends the connection to the selected device.



- The feedback of the change of device connection data is displayed in a popup window.
 - Connection successful, Already registered device, IP address crash, MAC address crash, Network error, ID error, PW error, Privilege error, Connection failed, Concurrent users exceeded, No response, S/W version mismatch, DDNS error, Number of allowable registered cameras has been exceeded, 5 times or more password errors with the ID, You can login only after 30 seconds. / Another user is already connected. Do you want to disconnect and login again?
- You can move the registered media gateway by dragging the device in the device tree with a mouse.
 - You can select only one device to move when moving the media gateway.
 - You can move a device registered under the Media Gateway in the device tree to a different Media Gateway by dragging and dropping it.
When you move the device, the existing settings will be maintained.
- If the MAC address does not match after the device is replaced, a pop-up window prompting you to change the settings will open.
 - In the pop-up window, click **<Yes>** to replace the device.
 - Otherwise, click **<No>** to maintain the existing device settings.
 - Only a device with the same model name can be used as a replacement.

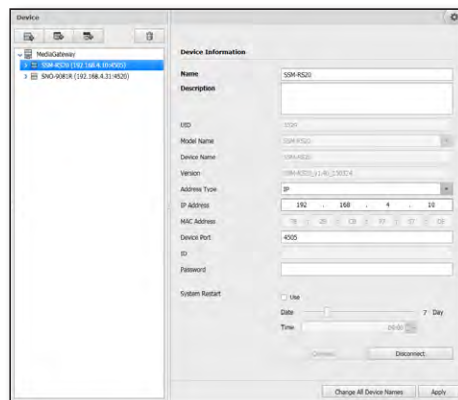

To change the names of all registered devices at once

1. click the [] button at the bottom left of the screen.
 - The [] button is activated only for the devices registered under the media gateway.
2. Enter a name to change and select subordinate objects (Camera, Sensor or Alarm Out) to which the change will be applied.

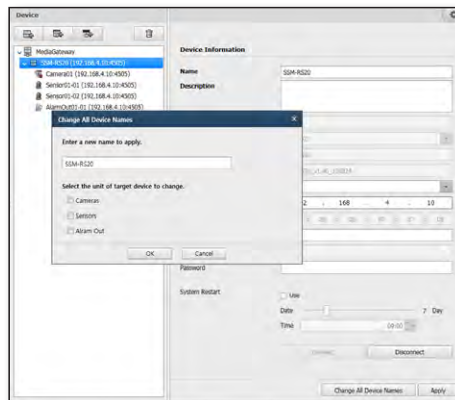

3. After you have finished entering the new name, press the [Apply] button. The names of devices will be changed all at once to the name entered by the user, and each of the subordinate devices will be numbered.

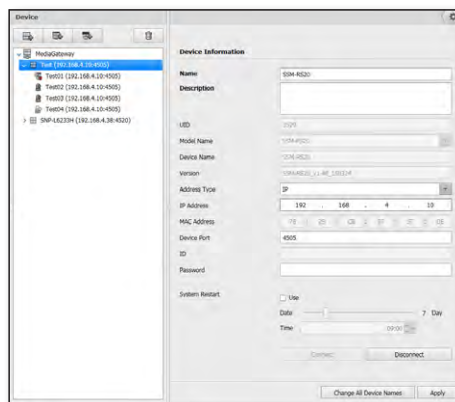

SSM configuration manager

If you want to modify the camera access information registered in the Recording Server

1. Select a camera registered in the Recording Server.
2. Click on the **[Access Info Settings]** button in the device information menu on the right hand side of the screen.
3. Modify the camera information displayed in the bottom right of the screen.
4. When finished, click **[Apply]** button.
 - Connecting/Releasing connection : It connects/disconnects the connection to the selected camera.

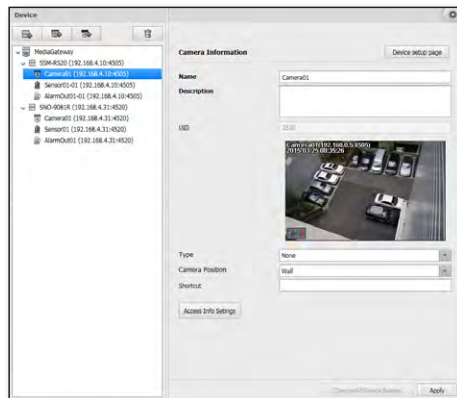

Viewing the Device Settings

You can see the device related settings information on the Settings Page provided by each device.

To edit device settings

1. In the right information pane, click **[Device setup page]** button.
The selected device's settings page should appear.
2. Edit settings as required.
3. When finished with device settings, click **[Apply]** button of the device settings page.
4. To close the device's settings page, click **[X]** button on the top right corner.
 - Device settings page differs from devices connected. For further details, refer to the user manual of each device.

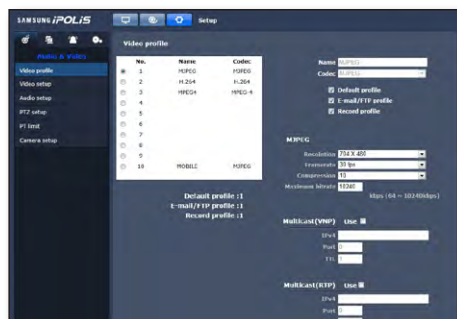

Camera Info View

Select a device and then a camera under it to check the connected camera information and video.

To Change Camera Info

1. Select a camera under the selected device.
2. Enter the name and description in the camera info window.



- If the Panomorph lens is installed, specify the camera position and lens type.
Check to ensure the camera model is compatible with the Panomorph lens.

3. When done, click **[Apply]** button.

- Type : The type of camera registered can be selected from "Box, Dome, PTZ, PT Driver, Panomorph, Fish-Eye". When a type is selected, its icon is displayed in the device tree of the Configuration Manager. In the case of Panomorph or Fish-Eye camera, the option must be set in advance to activate the dewarping function in the console.
- Camera position : Set the camera installation position.
- Shortcut : Only numbers are accepted for the shortcut to image output.

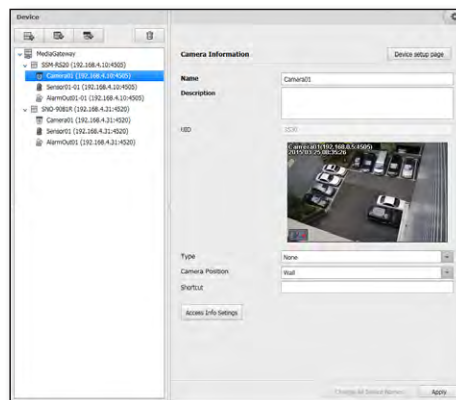

Sensor Information

Select a device and the lower level sensor to check the connected sensor data.

To change the sensor data

1. Select the lower level sensor of the device.
2. Input the name and description in the sensor information window.
3. Click the **[Apply]** button after setting.

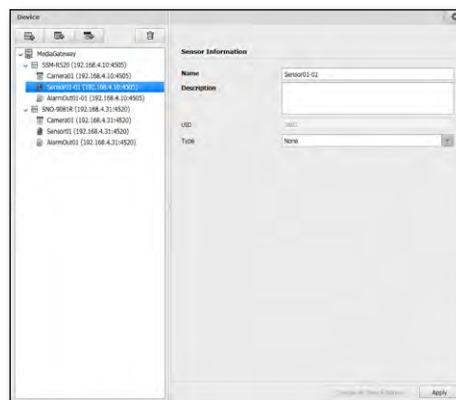

SSM configuration manager

Alarm Out Data

Select a device and select the lower level alarm to check the connected alarm data.

To change the alarm out data

1. Select the lower level alarm of the device.
2. Input the name and description in the alarm out information window.
3. Click the **[Apply]** button after setting.

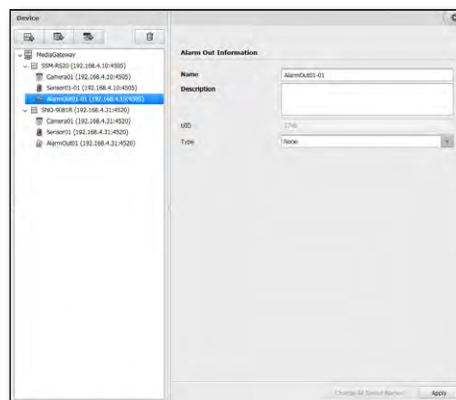

Deleting a Device

A device can be selectively deleted.

1. Select a device to delete from the tree.
2. Click [] button.
3. When confirmation prompts, click **[OK]**.
 - If the related camera is in playback or recording, it automatically aborts.
 - It is not possible to delete when a camera, sensor or alarm out object is selected.
 - Using the **<Ctrl>** or **<Shift>** key, select multiple devices in the device tree to delete them at the same time.



Select a camera registered in the Recording Server

You can select and delete each camera.

1. Select a camera to delete from the tree.
2. Click on the [] button.
3. When the camera delete confirmation window appears, click **[OK]**.
 - When you want to delete a camera registered in the Recording Server, in the device delete popup window, you can select to delete the recording file.
 - If you chose to delete the recording file, the recording data will be also deleted.
 - Using the **<Ctrl>** or **<Shift>** key, select multiple cameras registered in the Recording Server to delete them at the same time.

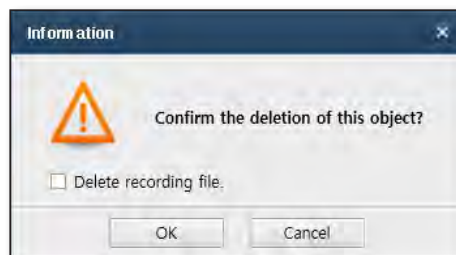

Recording Server Setting Information Management

You can import the Recording Server settings or export them as a .cab file or update the firmware for a registered camera.

Initializing the Recording Server system

1. Select the Recording Server to initialize.
2. Select initialization and click on the [Restore the Default] button.

Recording Server settings information management

You can import the Recording Server's settings information from a file.

1. Click on the [...] button to select the setting to retrieve.
2. Select a saved file.
3. Click on the [Import] button.
4. Imports the settings from the selected file.



- If you select the <All> checkbox, then you can retrieve <Hardware>, <Record>, <Network> and <System> items from the Recording Server. You can check and select each set of information.
- You can import multiple Recording Servers at the same time, but only one Recording Server can be exported at a time.

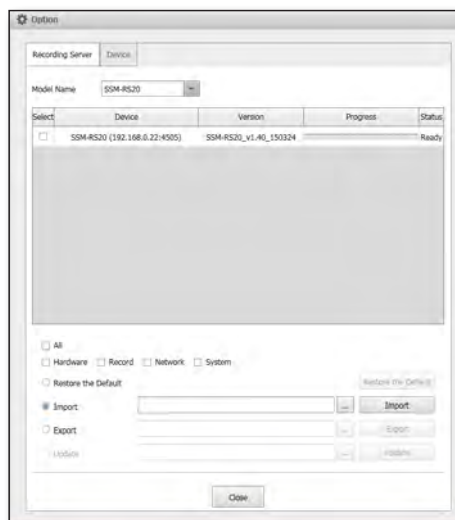

SSM configuration manager

Importing the Recording Server settings

You can save the Recording Server settings as a file.

1. Select the Recording Server to be saved as a file.
2. Click [...] button to browse and set the desired file path.
3. Click on the [Export] button.
Settings are saved as a file and the result is displayed as a message.

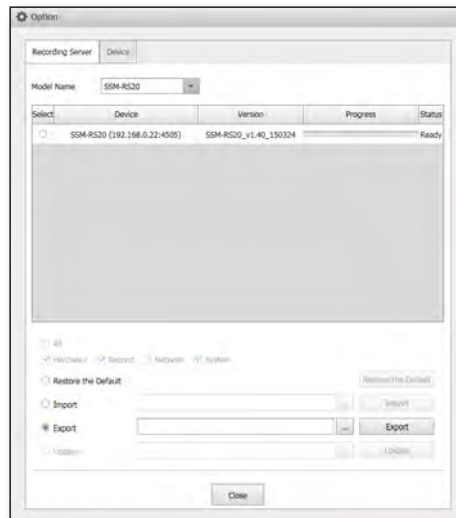

Updating camera firmware

You can update the firmware for a camera registered below the Recording Server.

1. Select a model to update.
2. Click on the [...] button to select the new Firmware to update.
3. Click on the [Update] button.
4. While it is updating, the progress bar indicates the progress.

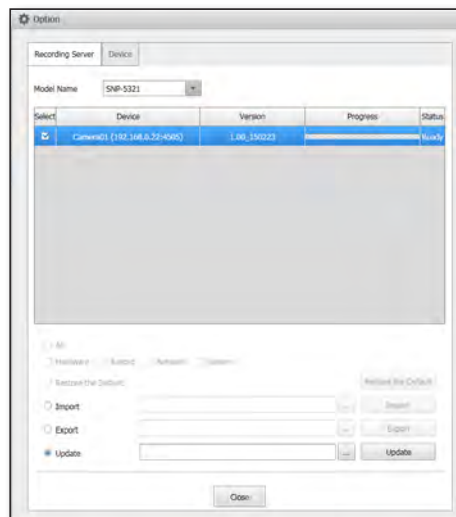

Managing Device Settings

You can import device settings from a file, or export it in *.dat format.

Importing Device Settings

You can import device's settings information from a file.

1. Click [...] button to browse and set the desired file path.
2. Select a settings file.
3. Click [Import] button.
4. Imports the settings from the selected file.

-  ■ If checked <Including Network Settings>, imports network environment settings too.
- Importing for multiple devices is allowed, where exporting limits to one device at a time.



Exporting Device Settings

You can save your device's settings information as a file.

1. Select desired device to export its settings.
2. Click [...] button to browse and set the desired file path.
3. Click [Export] button.
The settings are exported into a file, and its result is displayed as a message.



SSM configuration manager

Updating the Device Firmware

1. Select a device to update.
 2. Click [...] button to select update software of newer version.
 3. Click **[Update]** button.
 4. During the updating, the progress bar shows the progress.
-  ■ Devices of the same model can be selected together from the list and updated at the same time.



External Devices

You can add an external device.

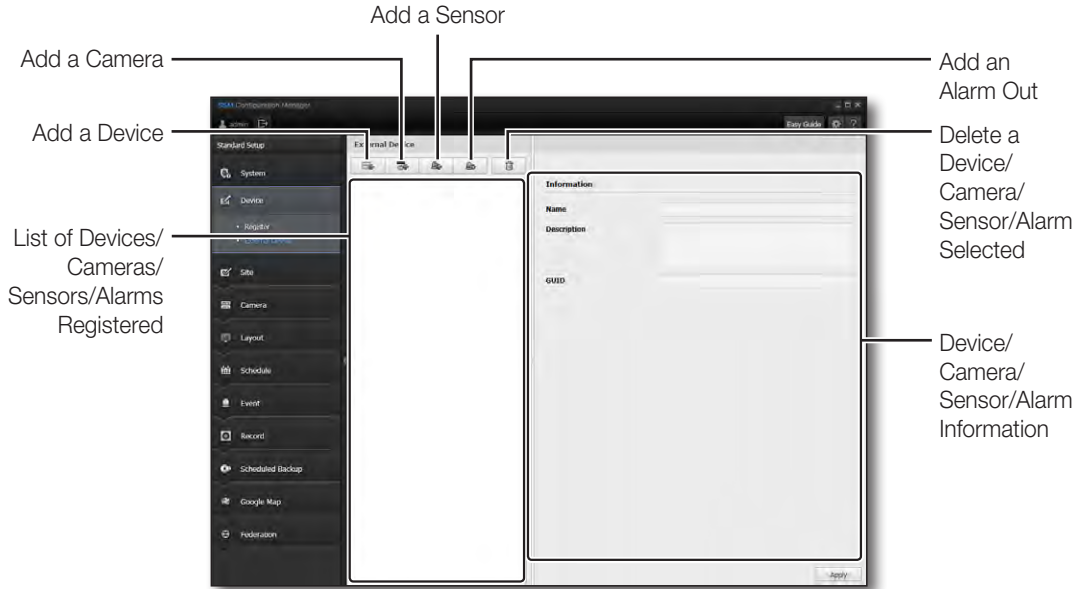

Register an External Device

To add an external device

1. Click the [] button.
2. Configure the specific settings of the device to register.
3. After completing the settings, click the **[Register]** button.



- After adding a device, you can add a camera, sensor or alarm out to the device added.
Add a camera, sensor or alarm out in the same way as adding a device.

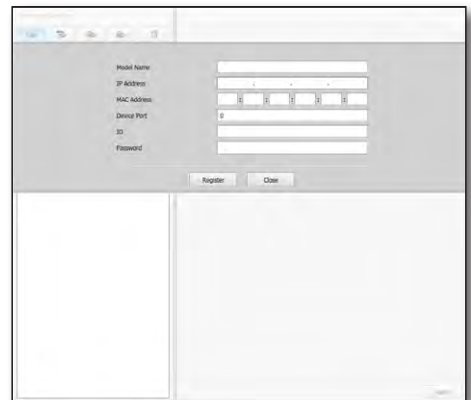

SSM configuration manager

SITE

Register a Site

In SSM, user accounts are administered for each Site where a site is considered to be a physical administrative unit.

Using Site

- Administration by locations grouped by Sites
- Permission management for viewer functions
- Site Management (Add / Edit / Delete)
 - Name, Description

Managing Sites

In the logical tree, a site can group camera and alarm out by location and it can help easier locating desired camera if there are many camera devices.

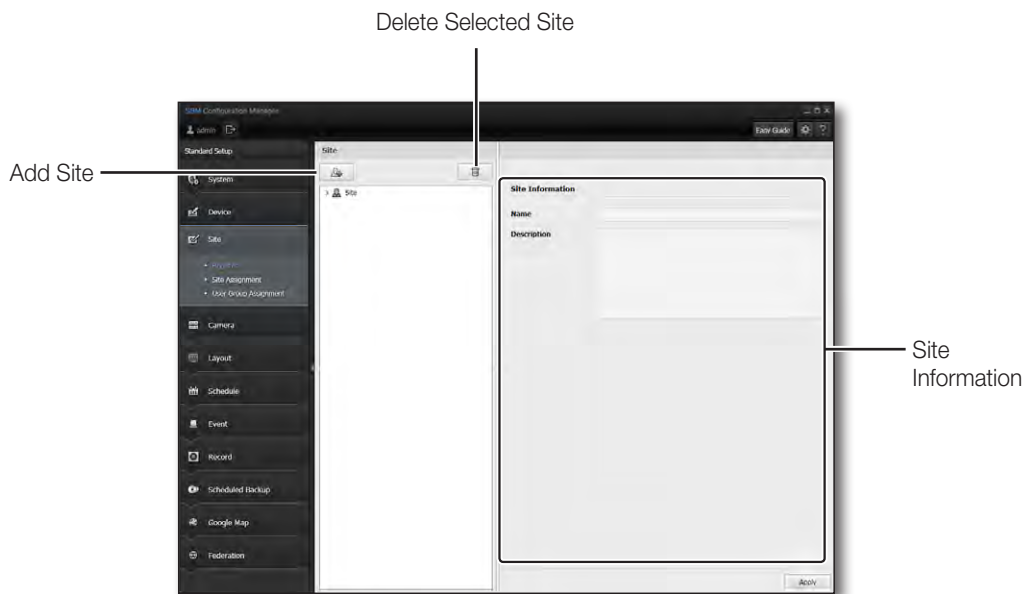

- ! ■ The default topmost site is created in program installation process, which is not to be deleted.

Using Site/User Group

You can configure a site and user groups at your preference.

Ex.) Below sample construction shows sites of "HQ", "Factory" and "Storage", where each site includes user groups of "Disaster Prevention" and "Security Dept", and added with users of "Chief Disaster Officer", "Front Gate Security" and "Rear Gate Security", "Parking Tower" and "Lobby", "CEO Room", "Disaster_Monitor1" and "Disaster_Monitor2", "Factory_Front_Security" and "Storage_Front_Security".

• Site

Administrator Group

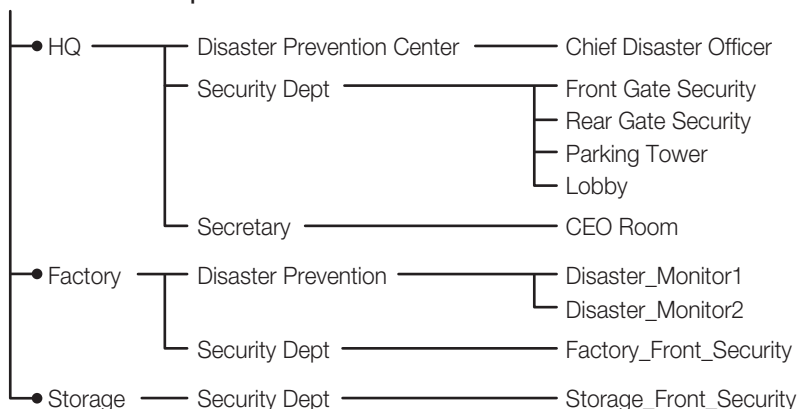

Setting a Site

To add a site

1. Click [] button.
2. Enter the site name and description in the right pane.

To edit a site

1. Select a site from the tree.
2. Edit site name and information on the right.
3. When finished, click [Apply] button.

To delete a site

1. Select a site from the tree.
2. Click [] button.

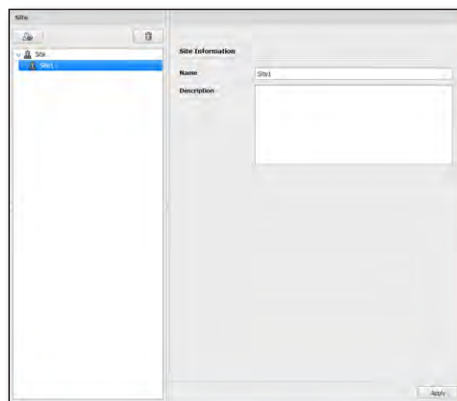

SSM configuration manager

Site Assignment

A device for the site is assigned.

A device can be selected and assigned to the site.

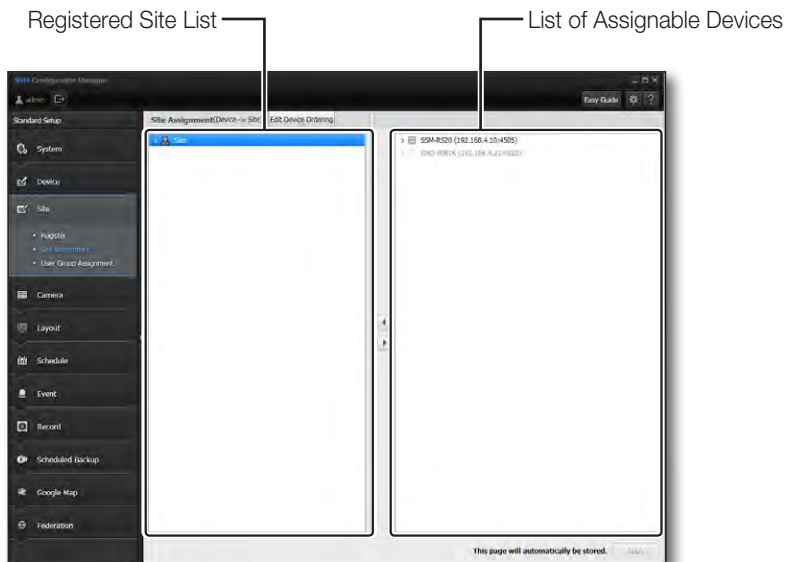

To Assign Cameras to a Site

1. Select a site.
The site must have been registered in "Register > Site".
2. Select a device and camera for the site.
To select multiple cameras, press the [Ctrl]/[Shift] key and then select the cameras.
3. Click the [◀] button after the camera(s) is(are) selected.
4. Select the device and then click the [▶] button to release the assignment.

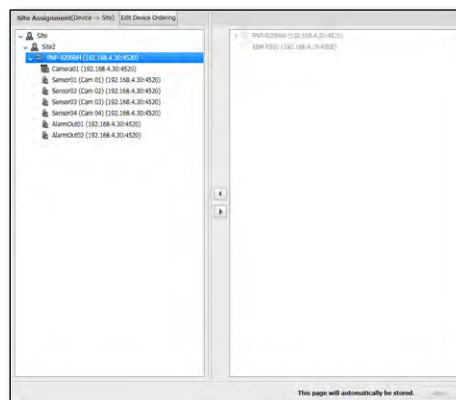

To change the order of subordinate devices assigned for each site

1. Click the [**Edit Device Ordering**] button on the tree of the assigned page.
2. Select device(s) to change the order and adjust the order using the [▲] or [▼] buttons.
 - When you click [**Edit Device Ordering**], the [◀] and [▶] buttons are changed to [▲] and [▼] buttons.
3. After completing the settings, press the [**Device Ordering Completed**] button.

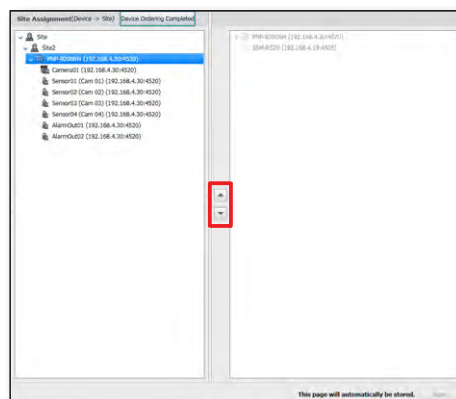

To set Align Devices/Search Object

Right-click on the site assignment page, and a window allowing you to select Align Devices or Search Object will be launched.

Select a desired setting item.

- By registration : Devices on the applicable device tree are aligned in the order of registration.
- By name : Devices on the applicable device tree are aligned in alphabetical order.
- Find Object : Enter the name of a device to search and select the search direction. Click the [Next] button and the next device is searched in the selected direction.

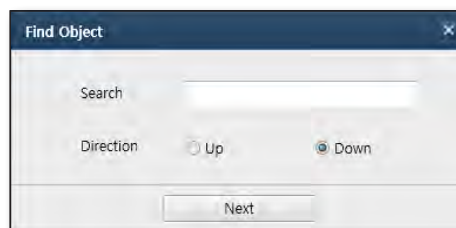
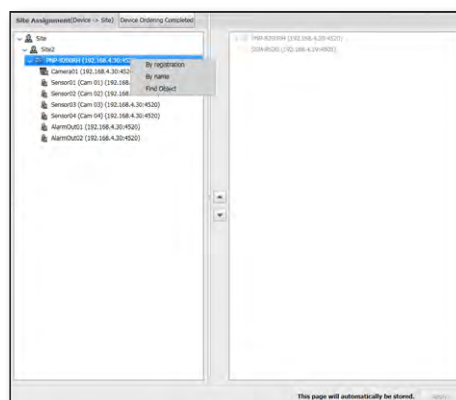

SSM configuration manager

User Group Assignment

A device registered in the site can be assigned to a user group.

The list of devices assigned to the selected site is displayed.

A device can be selected and registered to the selected user of the group.

Registered User Group List Assignable Site List

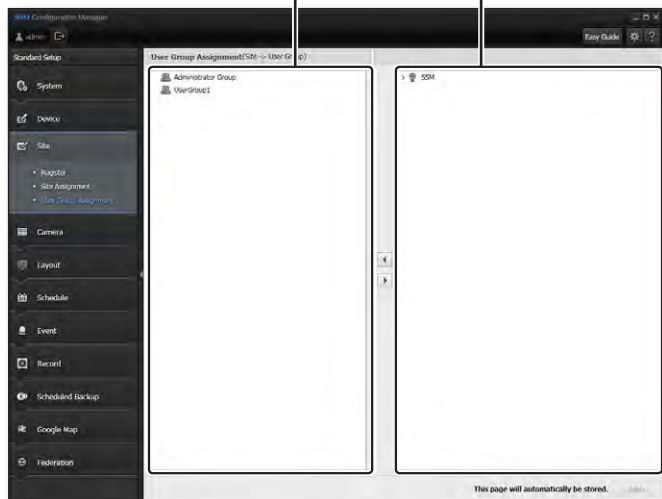

To Assign a Device Registered in the Site to a User Group

1. Select a user group to assign the site.
2. Select a site or camera to be assigned from the site list.
The list for selection displays only the cameras registered to the site, not all cameras connected to the device.
3. Click the [◀] button.
4. Select an assigned camera and then click the [▶] button to release the assignment.

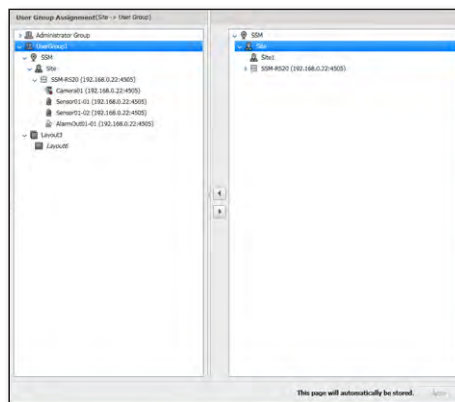

CAMERA MANAGEMENT

Profile

The profile of a camera assigned to the site can be checked and modified.

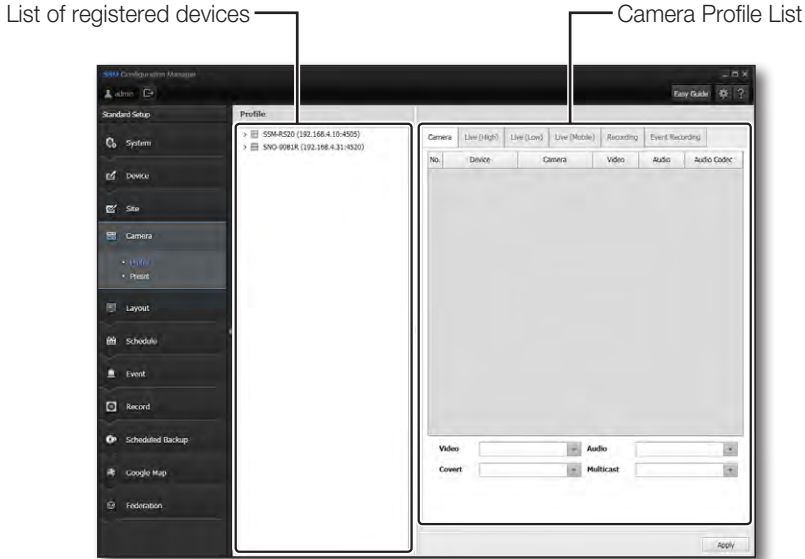

Camera

Video

1. Click on the **<Video>** menu of a camera to change video settings.
2. Select either **<Use>** or **<Not Use>**.
 - If you set the video of the camera to **<Not Use>** and you can't watch the live video.
If you set the video of the camera to **<Not Use>** and audio is also disabled automatically.

Audio

1. Select the **<Audio>** menu of a camera to change audio settings.
2. Select either **<Use>** or **<Not Use>**.
 - If you set the audio of the camera to **<Not Use>** and you can't listen to the live voice.
 - You can set audio recording in **[Record] > [Recording Camera Setup] > [Camera]** tab.

SSM configuration manager

Covert

1. Click on the <Covert> menu of a camera to change covert settings.
2. Check it.
<Covert> will be turned <On>.
 - If you check <Covert> of a camera, you cannot view live/searched video or listen to voice, but you can still record video or voice.

To change the camera profile, high resolution, low resolution, mobile and recording profile

1. Select the camera whose profile is to be modified from the list of cameras registered to the site.
The profile of the camera under the device can be set up, or the camera can be selected individually.
2. Select a camera to change the settings of from the list and select a changed value from the change item at the bottom.
3. To change the profile of the cameras in the list across the board, select the cameras using the [Ctrl] or [Shift] key in the keyboard and select the change value from the change item at the bottom.
4. Click the [Apply] button after the setup is complete.

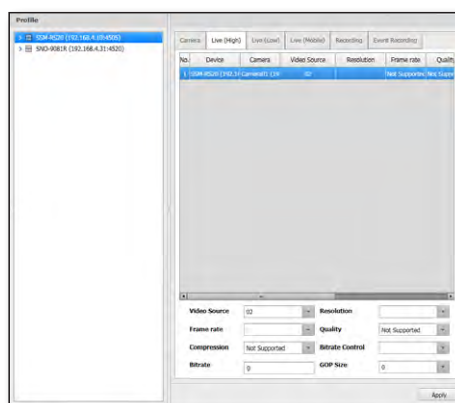

- You can set the recording profile for a camera registered in the recording server.
- You can set the Live (High), Live (Low), Live (Mobile), Recording and Event Recording properties for each camera.
 - In Video Properties, there are Resolution, Quality, Frame Rate, Compression, Bitrate Control, Bitrate and GOP size.
 - You can set the recording profile at the time when a recording server subordinate camera event is generated in the event recording profile.
- A camera registered in DVR and NVR cannot be changed.

Setting Presets

For PTZ control supporting cameras, you can add or delete preset positions for direct camera framing.



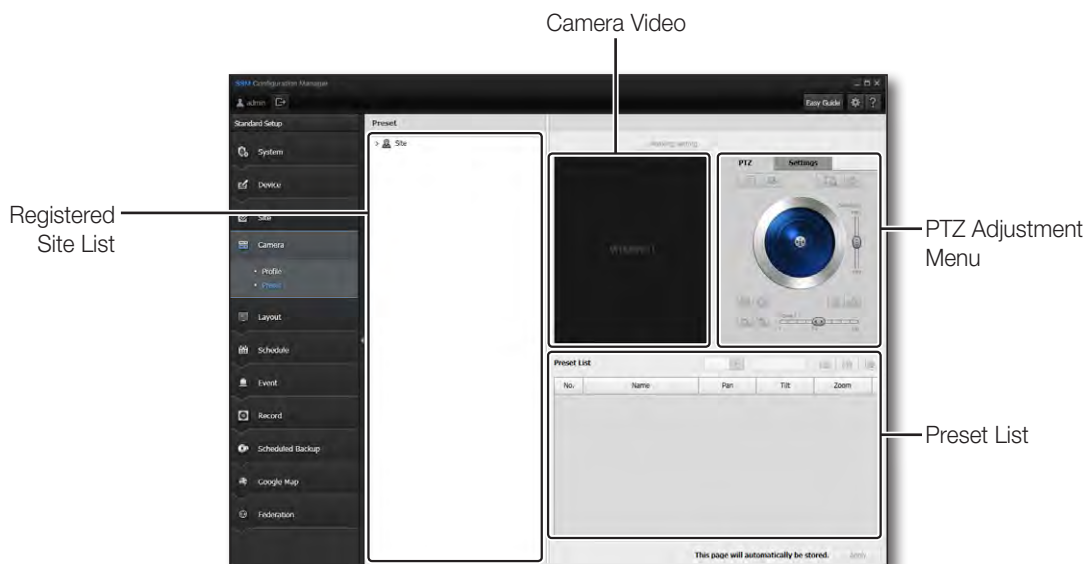

- The PTZ preset screen becomes available for settings, only when a PTZ supporting camera is selected.
- You can distinguish PTZ controllable cameras by icon appeared on the device list.
- According to the device, 20~255 presets are supported. Check the device specification for the maximum number of presets.
- A preset name can be set to a combination of letters and numbers up to 12 characters.



SSM configuration manager

If you want to add or delete a preset

1. Select a desired camera from the Device List to define a preset.
2. Use PTZ controller to set the camera framing to a desired point, and enter the preset name.
3. Click [] button.
In the preset list, added one appears.
4. To delete a preset, select the preset to be deleted, and click [] button.
 - In the case of cameras that support Homeposition, Fish Eye or Panomorph, the Homeposition item is automatically added to the preset list, and the preset position moves to the set home position when Homeposition is set.



- For further information on PTZ controller, refer to "PTZ Control". (Page 130)



To set preset touring

1. Click the [] button.
2. Add a preset to apply to a tour.
3. Set the touring time intervals.
4. After fully configuring the settings, click the [Apply] button to save and then click the [Close] button.

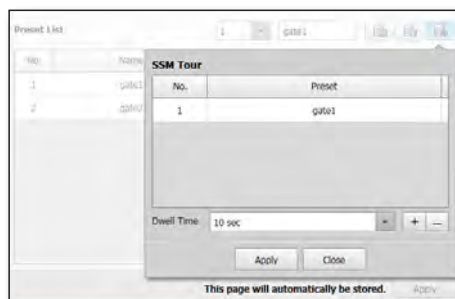

Setting

This section describes the camera image compensation. This setting is enabled only for the cameras registered with the SUNAPI protocol.

- Backlight compensation : the backlight compensation mode supports the level setting only when the WDR mode is set.
- Daytime/nighttime mode : Color, BW, auto, external BW and schedule can be selected.
- Simple focus : The auto focus is activated whenever the button is clicked.
- Focus : The focus is adjusted by setting the speed with the combo box. It can be set to 1, 10 or 100.
- Zoom in/out : A ratio is set from a combo box to enlarge or reduce the display by the set ratio. It can be set to 1, 10 or 100.
- P-Iris : The iris is opened by the set value to adjust the light exposure in the box or dome camera.
The level can be set by adjusting the slide or inputting a specific value.
The amount of light increases and the screen becomes lighter as the level increases.

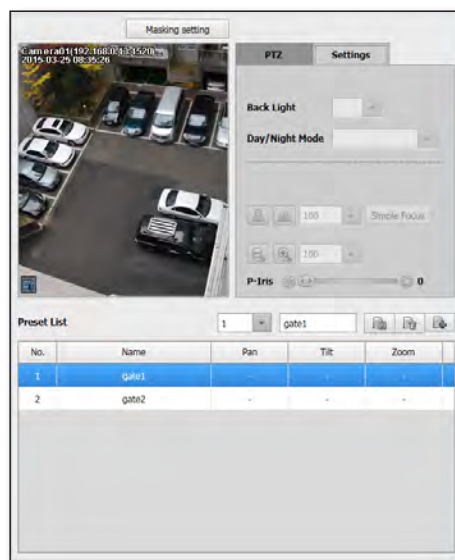

To set the Masking

1. Move to SSM Configuration Manager > Camera > Preset.
2. Click the Masking setting button and set the masking on the screen.
 - Click the beginning point and end point of the masking rectangle to set the mask rectangle.
 - Up to 8 masking settings are allowed.
3. Move to SSM Configuration Manager > System > User.
4. Set the authority for the output of mask in the live viewer or search viewer.
5. A mask configured in the live viewer or search viewer is output according to the authority configured.

SSM configuration manager

LAYOUT SETTING

Users can select the camera videos to be displayed on one screen.

A layout is generated, and the camera and site configuration included in the layout can be checked.

User can configure the screen specifically for a region, and select it for viewing whenever needed.

- When the layout is created, the ownership of the group with which the logged user is affiliated is created in the Configuration Manager.
- Layouts can be edited only when the user that has ownership logs in.

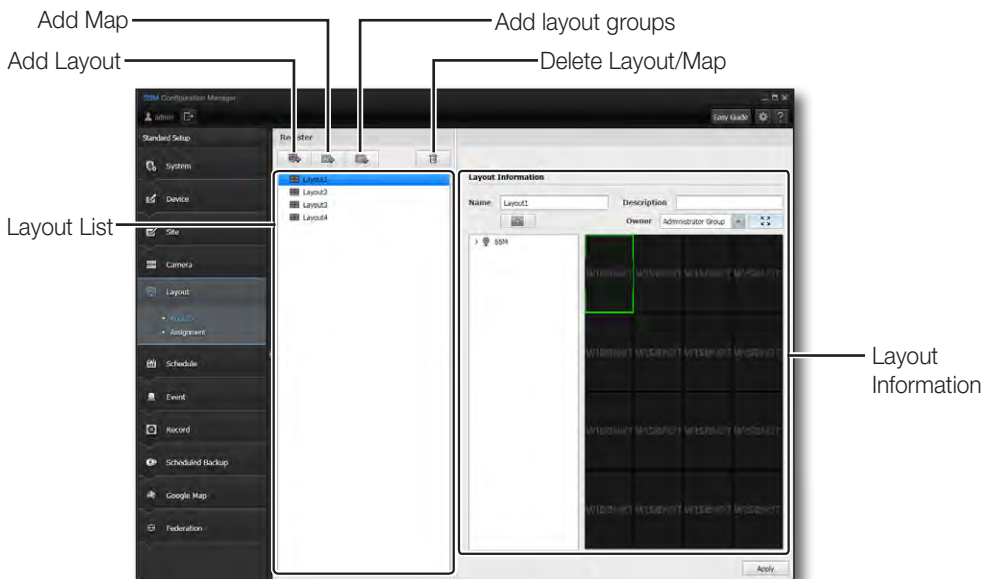

Registration

Camera Layout

Create a Camera Layout, and place the cameras in the desired tile of split screen to compose various layouts.

The device list only shows devices available for adding to the layout currently being edited, in a tree format.

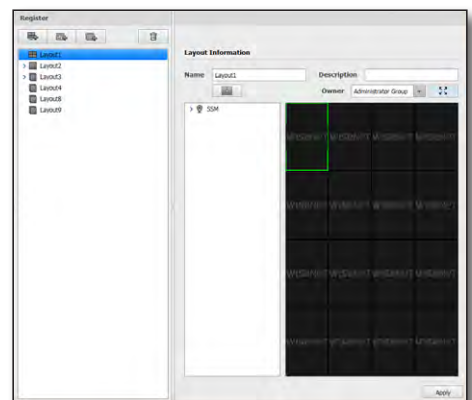

To add a camera layout

1. Click the [] button to generate the camera layout.
2. Click [Split Screen] button and select a desired layout split mode.
3. Drag a desired device from the device list, and drop in onto a tile.
Double-click a camera to add it to the layout. Double-click a system to add all cameras in the system to the layout.
4. When done, click [Apply] button.

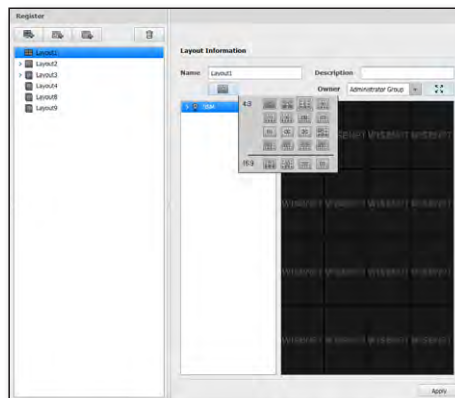

Map Layout

Place the camera and sensor icon in the position on the image of the registered map to complete the layout.

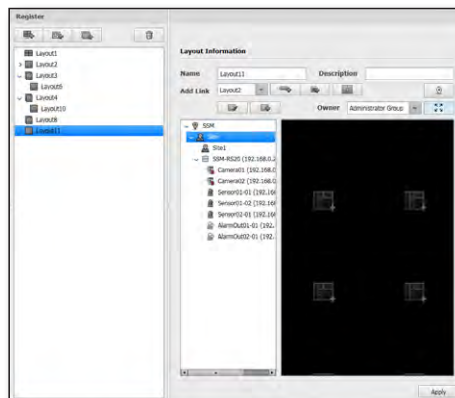



SSM configuration manager

To add a map and place links

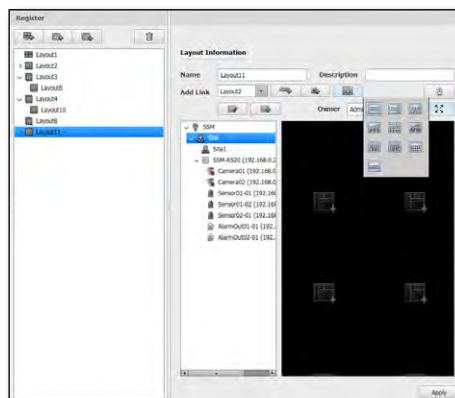
1. Select a user group to be added with a map layout, and click [] button to create one.
2. Select a newly-generated map.
3. Click [Split Screen] button and select a desired layout split mode.
 - In the split screen selection pane, the tile marked with sky blue is the destination tile of added map image.



4. Click [] button to browse and set the desired map image file.
5. Select a layout in <Add Link> and click the [] button.

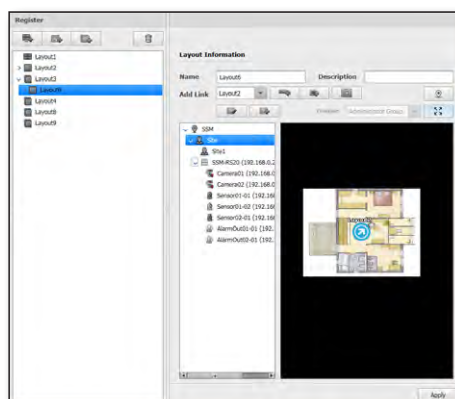

6. The link icon is registered in the map. Click the icon in the map layout of live viewer to move to the selected map link.



- Place mouse cursor on the top right corner of the map layout to display screen adjustment dialog. For further details screen adjustment on map layout, refer to "Layout". (Page 117)

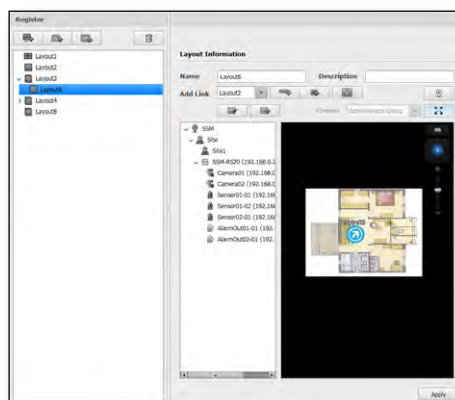

7. If you want to change the size/location of an icon, click on the [] button.

You can change the icon size and the font size and location.

8. If you want to add a user icon, click on the [] button.
- You can set the icon name. (32 Korean letters, 64 Roman alphabet letters)
 - You can designate the file to be used for the icon. (jpg, bmp or png format and size of less than 50Kbytes.)
 - Click the right side of the icon and select "Image change" to change the image of the icon.

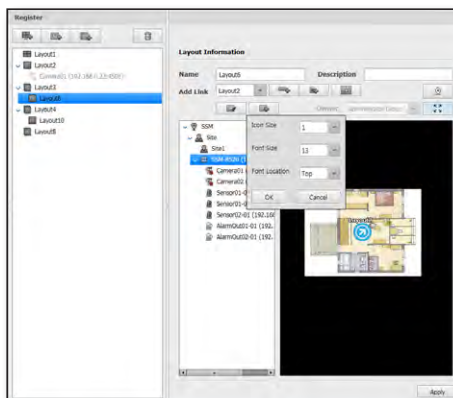

To add devices to a map

1. Once completed with adding a map, click devices to be added from the device list.

- In the device list, devices included in the group to where the layout is registered.

2. Click a device and drag it onto the desired position on the map, and release the mouse.

You can add any device of camera, alarm or sensor.

- Camera

- You can distinguish cameras, and identify whether the camera is connected to the network.
- You can identify cameras with events.
- The camera name is identified in the live viewer.
- The camera information is displayed in the live viewer.

- Alarm Out

- You can distinguish alarms, and identify whether the alarm device is connected to the network.
- You can identify alarm device names.
- You can turn on or off Alarm Out in the live viewer.

3. Click device icon with your left mouse button.
Green ball that controls camera framing appears.

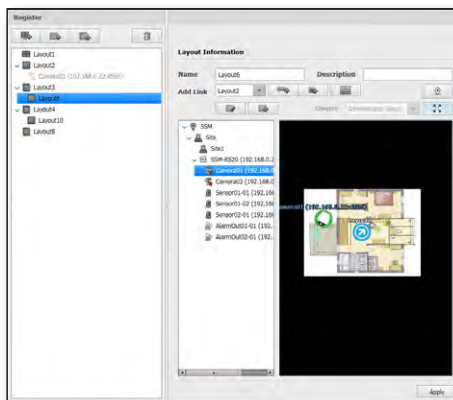

SSM configuration manager

- Click the green ball, and it turns red. While in red, drag and drop the ball to adjust camera's viewing direction.
 - Click a camera, drag and drop while holding to move the camera's position.



- "Refer to **"Using Map Layout"** on how to use the arrow keys." (Page 122)

- When done, click **[Apply]** button.

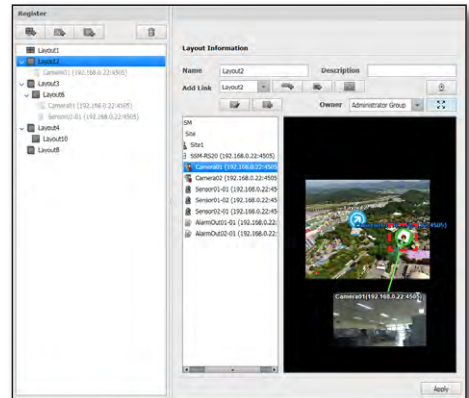

If you want to add a layout group

Add a layout group that can be used to group map layouts.

- Click on the [] button.
- Enter the name and description in the layout information filled on the right side.



- A map layout group can be added regardless of the existence of camera/map layout, but an existing map layout cannot be moved to the lower level of a map layout group. When a map layout is created after a created map layout group is selected, the map layout is located at the lower level of the map layout group.
 - You can add a map layout below a layout group. If a layout group is deleted, its sub map layouts will be also deleted.

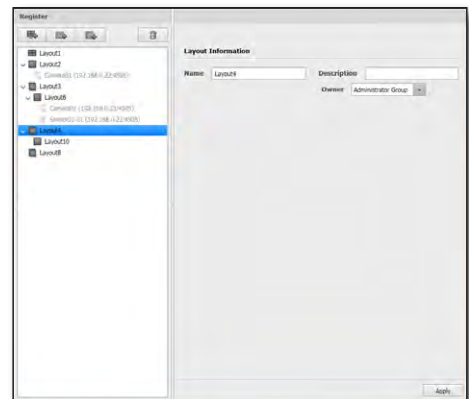

Layout coordinate settings

Click on the [] button to set the layout coordinates.

- A coordinate is displayed as three points on the map. When you set a coordinate, enter the reference coordinate value for each point.
- The range of layout coordinate input is shown as follows.
 - X/Y coordinate system
X : 0 ~ 10000, Y : 0 ~ 10000
 - Longitude/latitude coordinate system
Longitude - East/West, deg: 0 ~ 180, min : 0 ~ 59, sec : 0 ~ 59 (first decimal point)
Latitude - North/South, deg: 0 ~ 90, min : 0 ~ 59, sec : 0 ~ 59 (first decimal point)

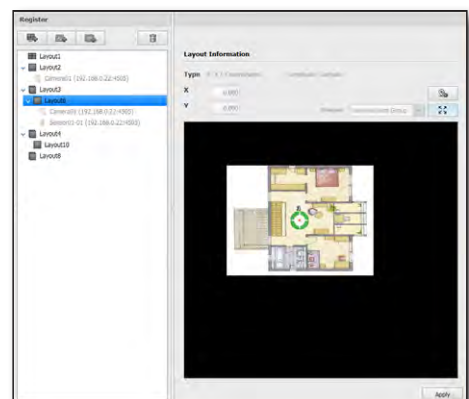

Deleting Layouts

Select layout to be deleted, and click [] button.

Layout Assignment

A layout is assigned to the user group.
 A list of layouts available to the selected user group is displayed.
 Select a layout and register it to the user group.

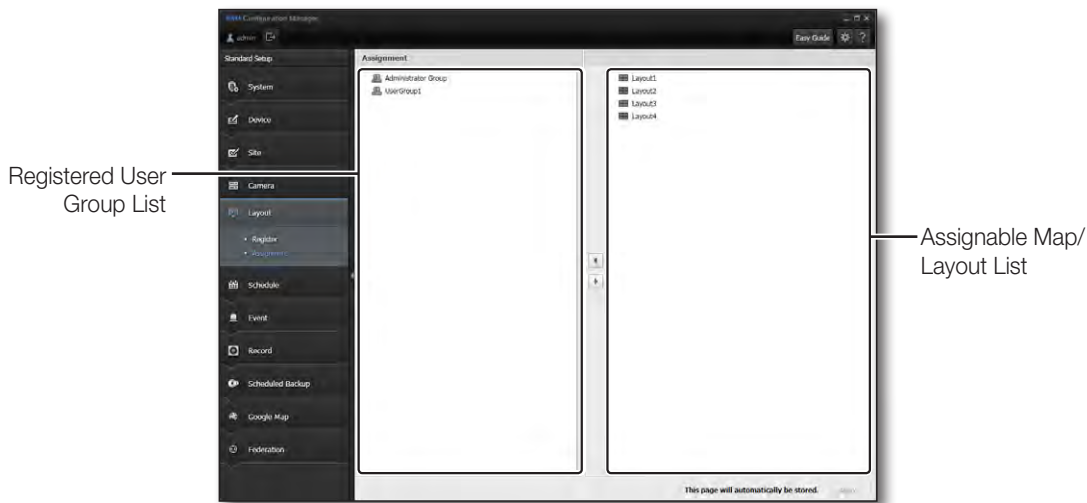

To Assign Cameras

1. Select a user group to assign the layout.
2. Click to select a layout to assign from the layout list.
3. Click the [◀] button.
4. Click the [▶] button to release the assignment.

- 
 - After a layout assigned to the user group has been selected, another layout under it can be assigned.
 - The layout can be allocated only when a user who has ownership logs in.

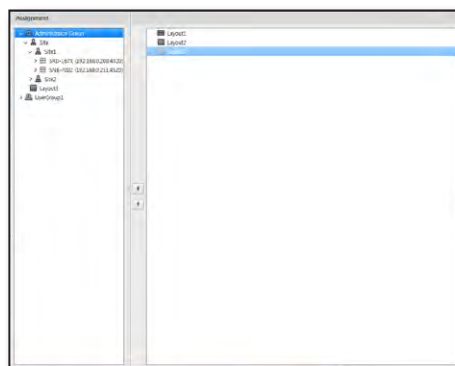

SSM configuration manager

SCHEDULE SETUP

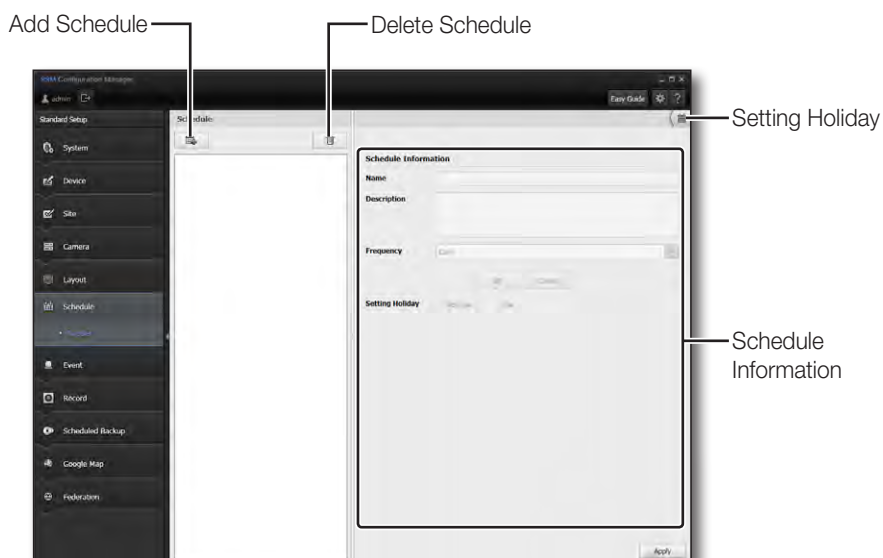

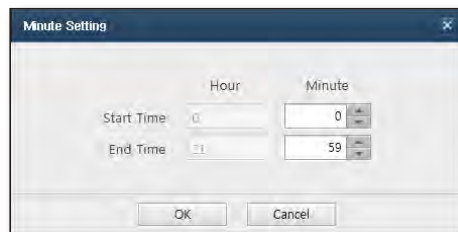
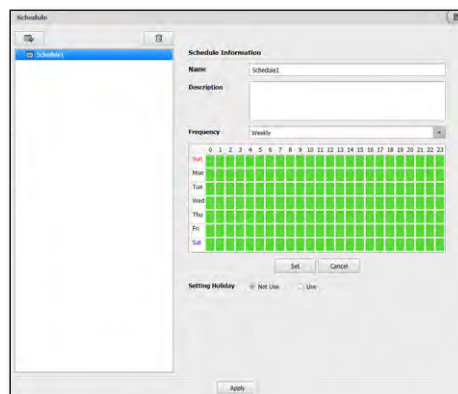

To Set up a Schedule

1. Click the [] button.
2. Select the generated schedule.
3. Enter the <Name> and <Description> in the list on the right hand side.
4. Select <Frequency>.
 - Daily : The schedule is set up in one-day units.
 - Weekly : The schedule is set up in one-week units.
5. Select a schedule area from the time selection cell, drag it with the mouse, and click the [Set] button. To cancel the schedule, drag the area and click the [Cancel] button.
 - Multiple time cells can be selected by using the [Ctrl] key.
6. Double-click the time selection cell and then select the minutes of <Start Time> and <End Time>.
7. Select whether the holidays will be used.
8. Click the [Apply] button after the setup is complete.



To Set up Holidays

1. To use holidays, select <Use>.
 2. Click [] in the upper-right corner.
 3. Select the dates that are holidays, and indicate the type of holiday.
 4. Click the schedule area in the time selection cell, drag it with the mouse, and click the [Set] button.
To cancel the schedule, drag the area and click the [Cancel] button.
 5. Double-click the time selection cell and then select the minutes of <Start Time> and <End Time>.
 6. Click the [Register] button after the setup is complete.
-  ■ Holiday setting is set at higher priority when <Setting Holiday> is set to <Use> in schedule setup.

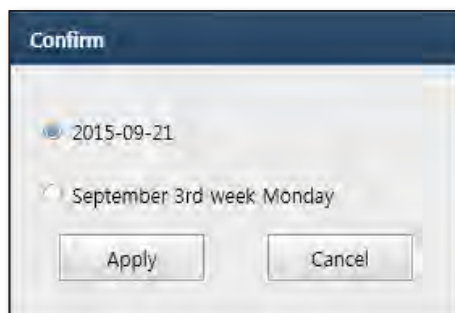
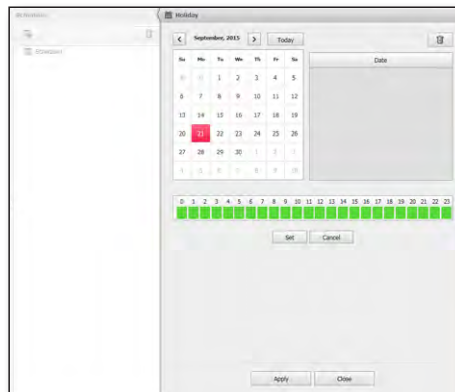

To Delete Schedule

1. Select the schedule to delete from the schedule list.
2. Click the [] button.
3. Click the [Apply] button after a schedule is deleted.

SSM configuration manager

EVENT

The event action defines how the system acts (output) upon a specific event (input).

Managing events

You can select to display events that occur, and set the color for an event that occurs.

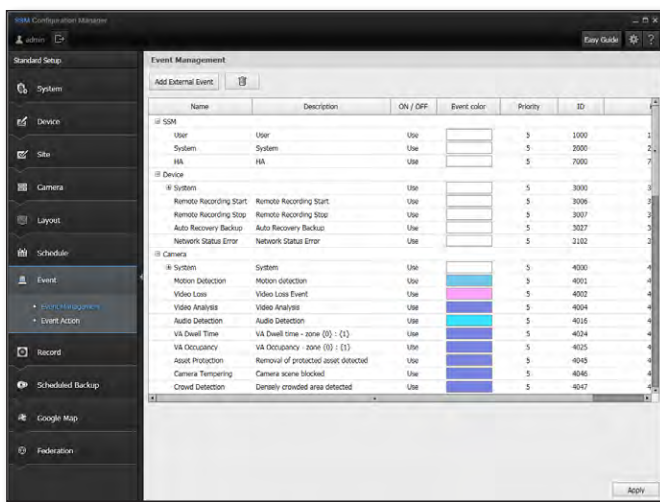

To set the event color

1. Select an event to set the color for.
2. Select whether to use the information displayed in the bottom.
3. Click on the <Event color> menu.
4. Click on the desired color in the color chart displayed.
5. After finishing settings, click on the [Apply] button.
 - If the event color is set, it is applied to the event log of the viewer and border of the camera image window.

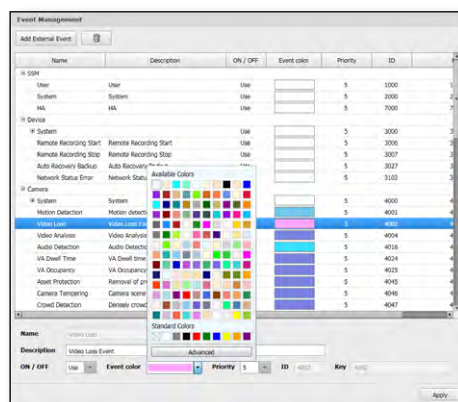

To add an external event

1. Click the <Add External Event> button at the top.
2. Input the event information.
3. After you finish configuring settings, click the [Add] button.

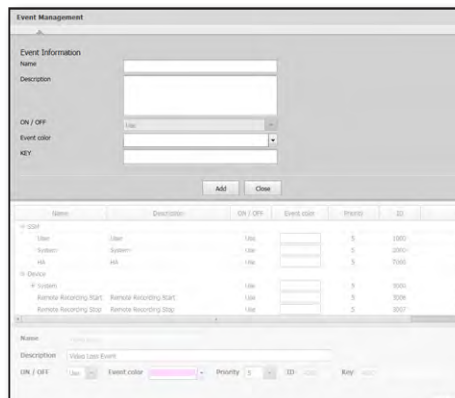

Setting Event Action

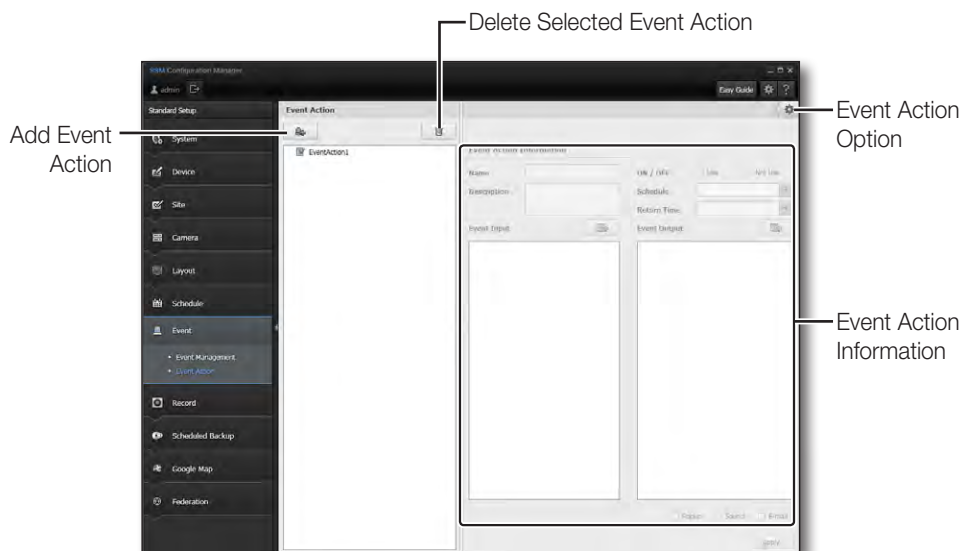



- Event Action
 - Event Action Management (Add / Edit / Delete)
 - Name, Description, Event (Input), Action (Output)
 - You can define various system actions (output) for events (input) from devices.
 - Event (input) types: Device connection release, Motion Detection, Video Loss, Video Analysis, Audio Detection and Sensor
 - Action (output) types: Instant Viewer, Preset, Alarm Out, Pop-up, Sound and E-mail notification

SSM configuration manager

To add an event action

You can add/edit event actions.

Select event type, device of action, and specify action details accordingly.

1. Click the [] button to add an event action.
2. Selecting an event button that is added prompts the event action information.
3. Use <ON/OFF> to determine the use of this function.
4. Enter the name and description of the event action added.
5. Select the usage and event action schedule.
6. Select the return time.
7. Click the [] button to select a device to configure in <Event Input>, then select a check box for each event type.

HA Event

- No Standby Client : The HA client (standby) does not exist at the time of fail-over request.
- Standby Client Broken : The HA client (standby) is in an error condition at the time of fail-over request.
- Fail-over Successful : The fail-over is established successfully.
- Fail-over Failed : The fail-over failed.
- Fail-back Successful : The fail-back is established successfully.
- Fail-back Failed : The fail-back failed.

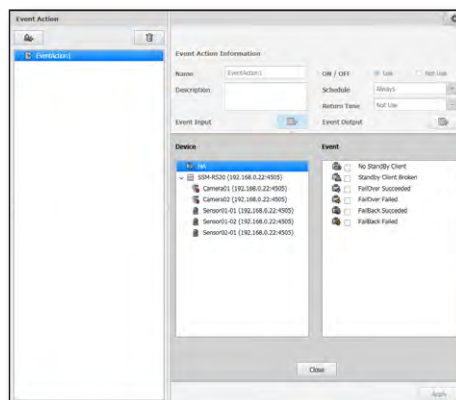

Device Event

- Motion Detection : If the device detects a motion, an event is generated.
- Video Loss : If the video recording is interrupted, an event is generated.
- Video Analysis : Intelligent video analysis is recognized as an event.
- Passing : An object passing through the area specified by the user is recognized as an event.
- Entering : An object entering the area specified by the user is recognized as an event.
- Exiting : An object exiting the area configured by the user is recognized as an event.

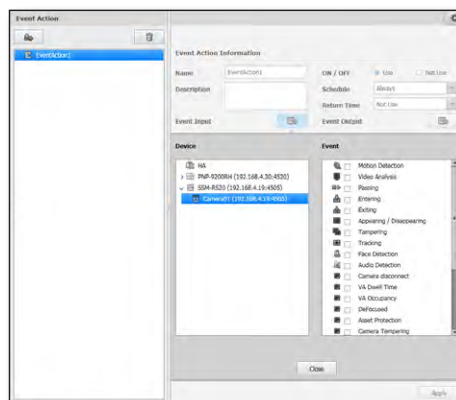

- Appearing/Disappearing : Object appearing in or disappearing from the specified area is recognized as an event.
 - Tampering : A situation hindering the video monitoring is recognized as an event.
 - Tracking : Recognize the situation of tracing moving objects on the screen as an event.
 - Face Detection : Recognize the situation of sensing a face in the user selected area as an event.
 - Audio Detection : If the device detects sound, an event is generated.
 - Camera disconnect : When a camera is disconnected, it is recognized as an event.
 - This is activated only for cameras that are registered to sub-RS.
 - DeFocused : Arbitrary control of the device's zoom focus is recognized as an event.
-  You can add an AgentVI-related event to use. For more information about settings and events, please refer to the SSM-TS manual and agentvi.com. The list of AgentVI is as follows.
- Asset Protection / Camera Tempering / Crowd Detection / Loitering / Occupancy / Stopped Vehicle / suspicious Object / Thermal Camera / Vehicle Tailgating
 - If you selected an upper ranked device that you registered a camera for, events related to device operation will be displayed.

8. Click the [] button to select a device to set in <Event Output>, and select a device and action to take when an event type is generated.

- Instant Viewer : Opens the "Instant Viewer" window in the Live Viewer, which shows the occurred event's video.
- Thumbnailis : Executes the thumbnail screen when an event is generated.
 - Activated only in the camera registered under the RS.
- Preset : Runs selected preset on the selected camera.
- Auto Broadcast : Runs the auto broadcast file when an event occurs.
- Tour : The tour of the selected device is performed in the case of an event.
- Swing/Auto Pan : The swing/auto pan of the selected device is performed in the case of an event.
- Group/Scan : The group/scan of the selected device is performed in the case of an event.
- Recording Start : Recording of the device selected when an event occurs is started.
- Recording Stop : Recording that is started when an event that occurs is stopped.
- Auto broadcasting music source : Search for and select and preview the music file to be played when an event occurs.
- Popup : Automatically selected along with Instant Viewer option. If selected individually without selecting Instant Viewer, an empty Instant Viewer having no video displayed upon an event only for reacting to the occurred event.
- Sound : Generates sound alarm upon events.
- E-mail : Sends out event notification e-mail upon events.

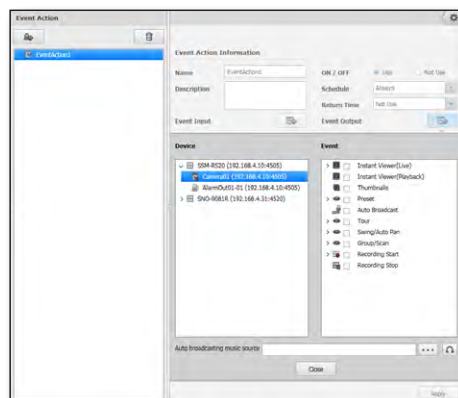

9. To finish settings and close the window, click [**Apply**] button.

To delete an event action

Select an event action to be deleted, and click [] button.

SSM configuration manager

To Set up Event Option



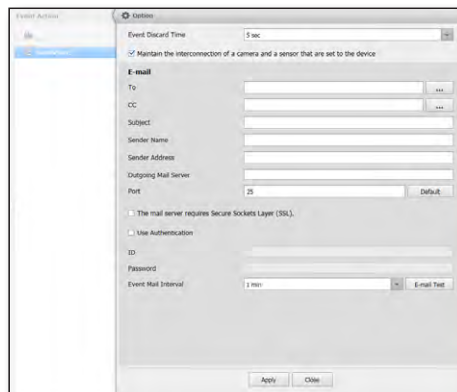

The ignore time and e-mail send time options of the event action can be set.

1. Click the [] button.
2. Specify the event ignore time.
3. Specify whether the device event action setting will be used.
4. Enter the recipient and sender e-mail addresses and e-mail sending interval when an event is generated.
5. Click the [Apply] button after the date input is complete.



To Select an e-Mail Recipient or CC

Recipient and CC of the event e-mail can be selected from the user group list, or their e-mail addresses can be input.

1. Click the [] button.
2. Click the [] button to the right of the <To> or <CC>.
3. Select the recipient of the e-mail from the users in the user group.
4. Click the [] button.
The e-mail address of the recipient selected from the e-mail list is displayed.
5. To register the e-mail address of the user not in the user group, enter the address in <Enter an e-mail address>.
6. Click the [] button.
7. Click the [Confirm] button after the recipient and CC are selected.

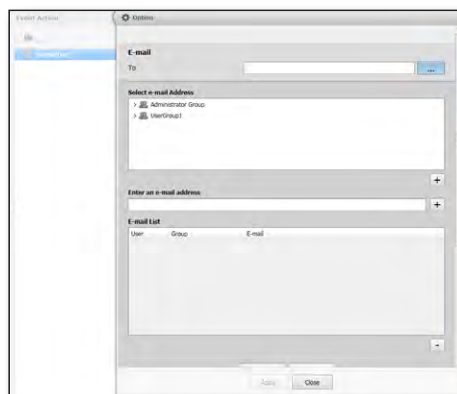

RECORD

Recording Server list

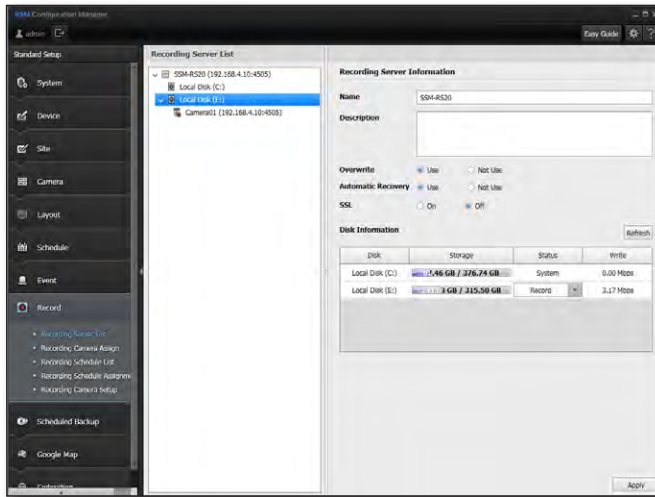

To set the Recording Server information

1. **Overwrite** : If there is no extra disk space, select whether or not to overwrite the recording file.
2. **Auto recovery** : If you record it in network external storage (iSCSI), select whether to auto recover the recording when a storage connection is cut off and stored again.
3. **SSL** : Sets whether to use SSL On/Off for each server.
 - If set to use in the "**System** > **SSL**" item, the applicable item is displayed.
4. **Recording Server disk information settings** : Shows the disk information of the selected Recording Server.
 - **Record** : When the disk status is set to **[Record]**, you can search for and play the recording.
 - **Restore** : If the disk status is **[Restore]**, the recording data can be restored in the case of HA fail-back.
 - **Released** : When the disk status is set to **[Released]**, you can search or play only but cannot record. Any ongoing recording will be stopped.
 - You cannot allocate a **[System]** disk where the OS is installed.
 - You cannot record if there is no **[Record]** disk as well as the **[System]** disk.
5. **Refresh** : Click on the **[Refresh]** button to update the local disk information with the latest information.

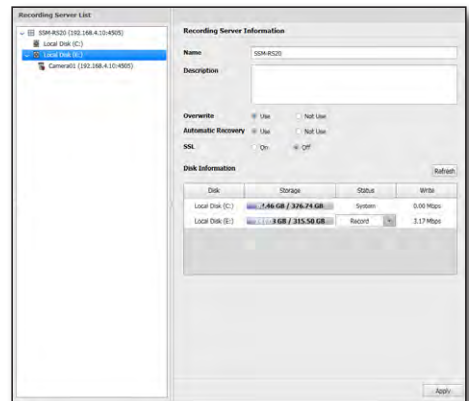

SSM configuration manager

- When it is necessary to format a disk on which recording is already in progress as it is set to a **[Record]** state in the recording server
 - Change the disk state to **[Released]** before formatting the disk.
 - If the disk state is changed to **[Released]**, recording on the applicable disk is suspended.
 - Format the disk.
 - After you finish formatting the disk, change the disk state to **[Record]**.
 - Reset the camera's disk allocation information and schedule allocation information after formatting the disk.

Recording Camera Assign

You can distribute camera to each **[Record]** disk of the Recording Server.

List of registered recording disks

List of allocatable cameras

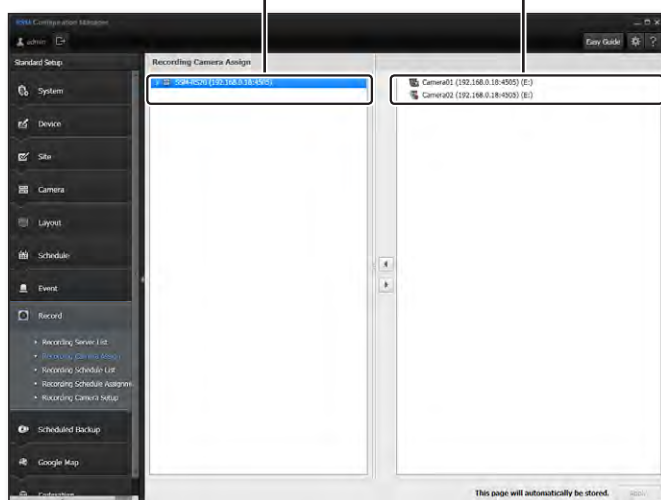

To assign a record camera to the **[Record]** disk

- Select the Recording Server to initialize.
- Select the **[Record]** disk to assign a camera to.
- In the list of cameras registered in the Recording Server on the right, select a camera to be assigned to the disk.
- Click on the [<] button.
The selected camera will be copied below the **[Record]** disk.
You can assign the same camera to multiple disks.
 - You cannot record with a camera not distributed to the disk.

To release a record camera assigned to the **[Record]** disk

- Select the Recording Server from the list on the left..
- Select an item to cancel from the list of cameras registered within the **[Record]** disk.
- Click on the [>] button.
The selected disk will be deleted from the **[Record]** disk.

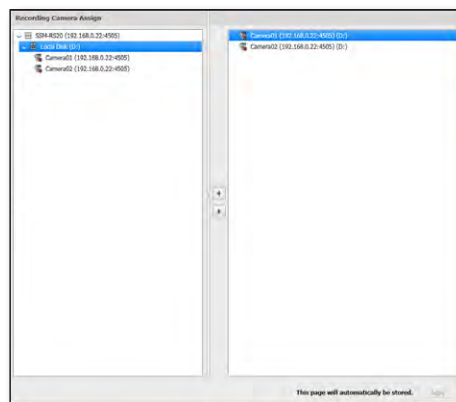

Recording Schedule List

You can create, modify or delete the recording schedules.

Add a recording schedule

Delete a schedule

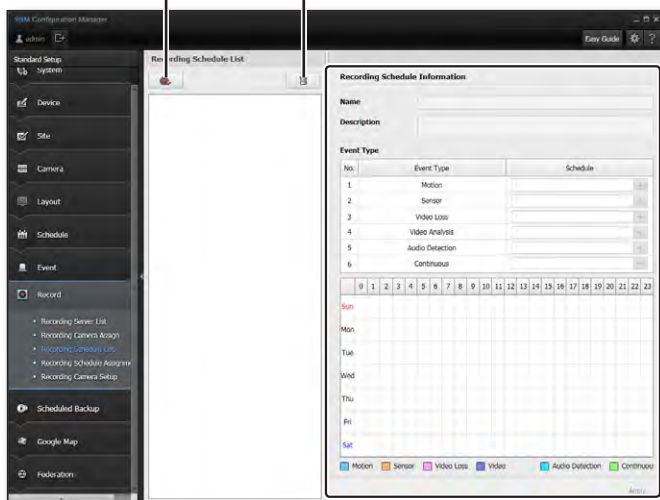

Recording schedule information

If you want to set the schedule

1. Click on the [] button.
2. Select a created schedule.
3. In the list on the right of the screen, enter <Name> and <Description>.
4. Select a schedule for each event type.
 - Schedule Always : Recording will be done on every day/time.
 - For more detailed information on schedule setting, refer to "Schedule Setup". (Page 72)
5. Click the [Apply] button after setup is completed.

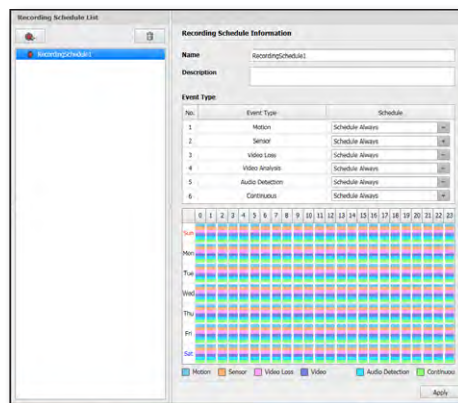

If you want to delete a recording schedule

1. Select a schedule to delete from the schedule list.
2. Click on the [] button.
3. Click the [Apply] button after deleting it.

SSM configuration manager

Recording Schedule Assignment

You can distribute a camera for each Record disk of the Recording Server.

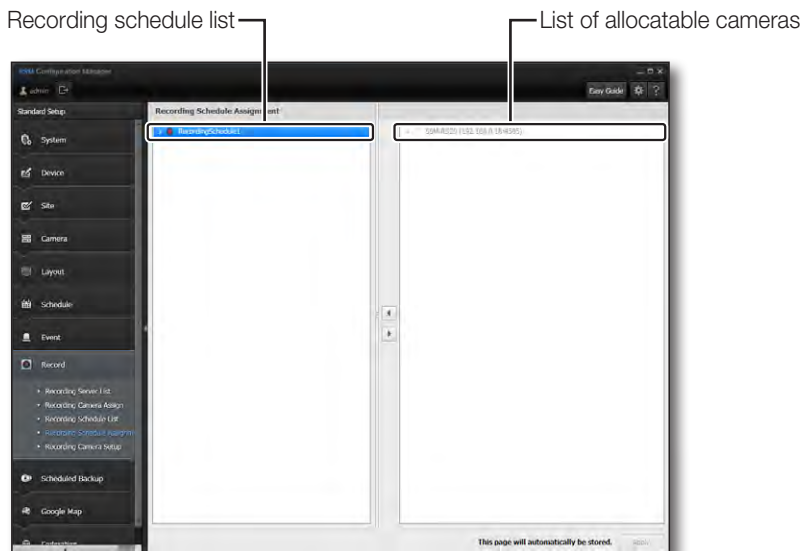

If you want to assign a camera to the recording schedule

1. Select a user recording schedule to which a camera will be assigned.
2. Select the Recording Server or camera to assign from the list of camera/Recording Servers on the right side of the screen.
 - If you select a Recording Server, the list of cameras below it will be shown on the right side of the screen.
3. Click on the [◀] button.
4. Click on the [▶] button to cancel assignments.
5. If you want to set all cameras in the list at once, press the [Ctrl] or [Shift] key to select cameras.

- Only the cameras assigned to the recording disk can be assigned to a recording schedule.

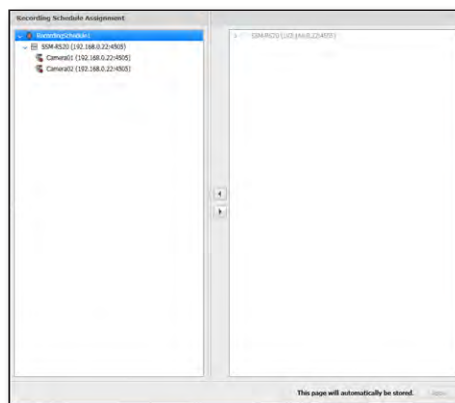

Recording Camera Setup

You can check or change the settings of cameras assigned to the server.

List of available camera settings

Displaying the camera settings information

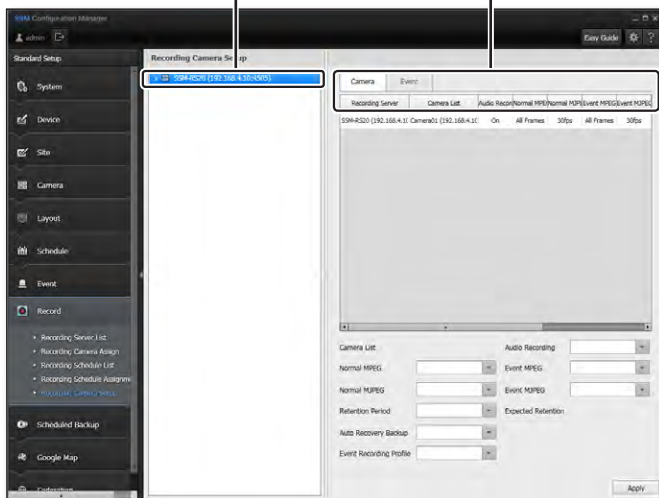

To change the record camera settings

1. Select a camera registered in the Recording Server that you want to change the setting for.
2. Press the **[Ctrl]** or **[Shift]** key to select the camera to change the setting for.
3. Select a camera to change the setting of from the list and select a change value from the change item at the bottom.
4. To change the setting of the cameras in the list across the board, select the cameras using the **[Ctrl]** or **[Shift]** key in the keyboard and select the change value from the change item at the bottom.
5. Click the **[Apply]** button after setup is completed.
 - You can set the fps used for each camera and recording type (general/event) registered in the Recording Server.

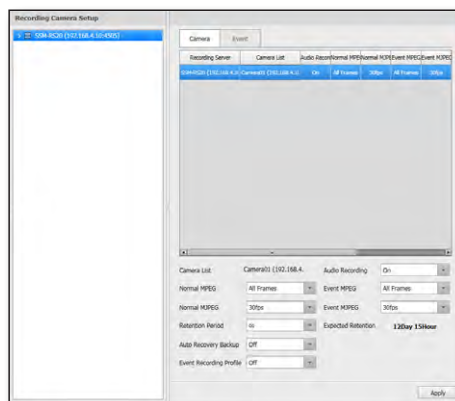

- You can turn the audio recording on or off.
If you set the camera's Audio Recording to **<Off>**, you cannot record voices.
- General recording types includes manual recording and continuous schedule recording.
- Event recording type includes : motion/alarm/video loss/intelligent video analysis/audio.
You can set the recording file storage period for each camera activated.
- A recording file that exceeds the storage period will be automatically deleted.
You can check the recording file storage period for each camera activated.
- Press the Refresh button to renew the available storage period that is displayed.

SSM configuration manager

- The Auto Recovery Backup function can be set to On/Off.
If set to <On>, the camera with the function is regarded as 2 cameras (if there are 16 actual cameras, they are regarded as 32 cameras when the function is set to On).
- You can set the event recording profile to On or Off.

Video settings	Options	Descriptions
MPEG	ALL FRAMES	Saving all frames received.
	KEY FRAMES	Only saves the I-frame received.
MJPEG	1 ~ 30	Uses the selected fps to save.

This setting will not overwrite the device video setting.

The actual frame rate used to receive and save data from a device may differ from the frame rate set here. If a smaller amount of data is received, only that much will be saved.

- The max throughput is 400Mbps.
- For recording stability, using HDD with SATA2 7200rpm or higher is recommended.
(Each HDD's max recording processing should not exceed 100Mbps.)
- The recording data can be searched or played by using the SSM console.

Auto Recovery Backup

Video that is not recorded due to disconnection from the equipment can be backed up after the connection with the equipment is re-established.

To use the auto recovery backup function

1. The camera and the recording server should be time synchronized and the time zone information should also be identical.
2. The recording should proceed on the camera's SD card.
 - It is possible to configure record settings after inserting a micro SD card into the camera.
 - As you can check the SD card recording status on the Playback page of the equipment web viewer, check first whether the equipment SD card contains the recording data if the Auto Recovery Backup function does not work.

To configure the auto recovery backup function

1. Register the camera in the recording server as a SUNAPI protocol.
2. Assign the camera to the [Record] disk.
3. Assign the camera to the recording schedule.
 - For a section in which recording is not possible due to the settings, the Auto Recovery Backup function will not work.
4. In the recording camera settings, set the Auto Recovery Backup function to <On>.

To check the Auto Recovery Backup results

When running the Auto Recovery Backup function, the timeline for the section backed up by the equipment is displayed as an [Auto Recovery Backup] item in the search viewer.

To change an event setting

1. Select an event item camera registered in the Recording Server that you want to change the recording setting for.
2. Select a camera to change the setting of from the list and select a change value from the change item at the bottom.
 - If you turn off the time setting, nothing will be recorded.
3. To change the setting of the cameras in the list across the board, select the cameras using the **[Ctrl]** or **[Shift]** key in the keyboard and select the change value from the change item at the bottom.
4. Click the **[Apply]** button after the setup is completed.
 - You can set pre/post recording time with respect to the time the event occurs so that users can easily understand the situation when an event occurs. Video during the pre/post time set based on the time the event occurs will be recorded.
 - Motion, alarm, intelligent video analysis, audio event : You can set both the pre/post time.
 - Video loss event : As there is no video to record after an event occurs, you can only set the pre time.
 - A video loss event only occurs in an encoder.

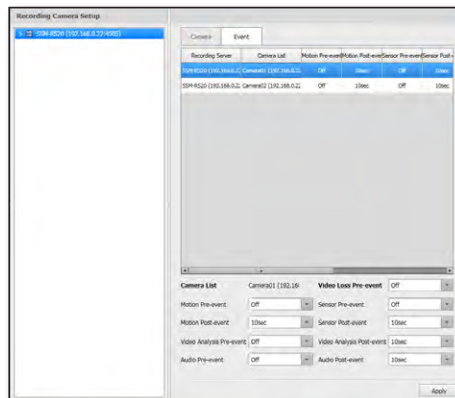

SSM configuration manager

SCHEDULED BACKUP

The data of a specific period can be saved in the PC running the program.

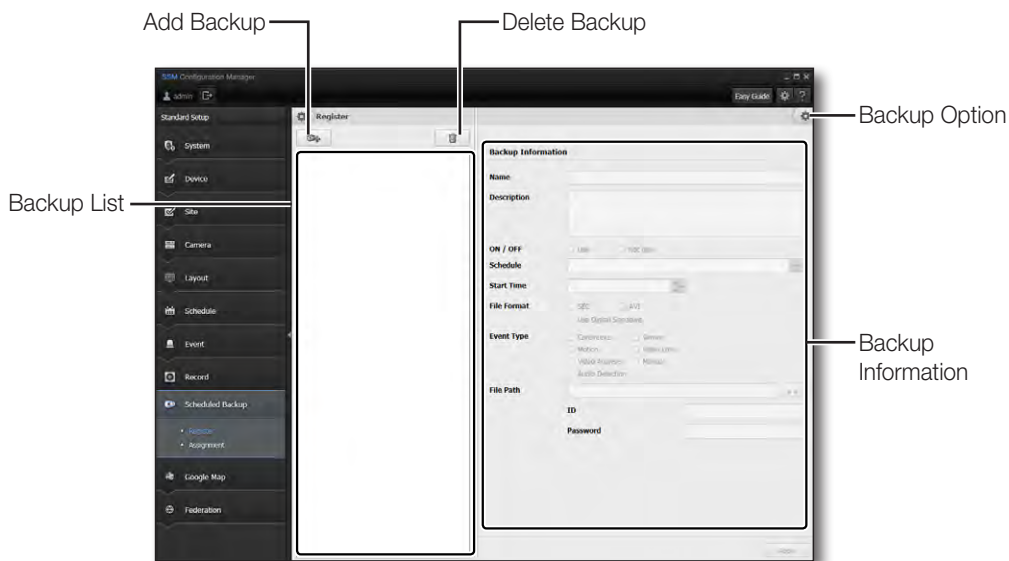

To Set up Video Backup

The specified event backup can be set up to run at the specified time.

1. Click the [] button.
A new backup is added to the list.
 - Only the connected devices can be backed up.
2. Click a backup from the list to select it.
3. Enter the name and description of the backup to set up.
4. Select whether the backup will be used.
5. Select a schedule.
One of the schedules registered in schedule setup can be selected.
6. Set up the backup time.
 - If the schedule is set to <Weekly>, the day of the week selection menu is displayed.
 - If the schedule is set to <Daily> and the backup schedule is set up for within 24 hours from the time selected as the backup start time, the backup begins with the data of the previous day.

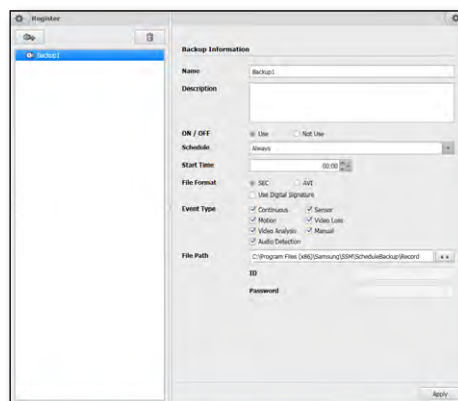

7. Select the format of the saved file.

“*.sec” and “*.avi” are available as the backup file format.

- AVI : General purpose format. This can be played by Window Media Player.
- SEC : Samsung's own format. Player is provided with the video data.



- Window Media Player does not support avi files with a resolution of 3 megapixels or higher. SEC backup is recommended for high-resolution videos of 3 megapixels or more.
- A new AVI backup file is created in the following cases.
 - When you change the video's resolution
 - When you change the audio or video codec
 - When the file size is greater than 2GB
- When the Digital Signature check box is selected when backing up the SEC, you can register a digital signature in the backup file.

8. Select the event type to run a backup.

9. Click the [...] button to select the path of the backup file.

- Input the ID and password to login to the NAS drive.
 - If the following popup window is displayed, check the input NAS account or disconnect the previous network connection and try again.

10. Click the [Apply] button after the setup is complete.

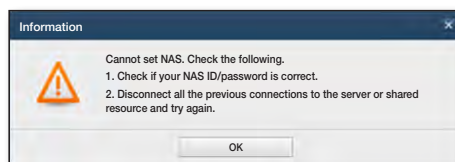

To Delete a Scheduled Backup

1. Select the scheduled backup to delete from the backup list.
2. Click the [] button, and then click the [OK] button in the confirmation window.
3. Click the [Apply] button after the scheduled backup is deleted.

To Check Scheduled Backup Status

1. Click the [] button in the upper-left section of the screen.
2. Check the progress of the registered backup.

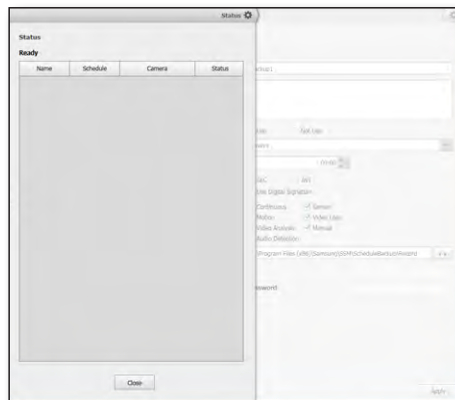

SSM configuration manager

To Set up a Backup Option

1. Click the [] button in the upper-right section of the screen.
2. Specify the automatic backup file delete capacity and period.
 - Minimum Free Space : Configure the minimum free space.
 - File Retention Period : Configure the automatic delete period.
Data recorded prior to the specified period are automatically deleted.
3. Check to use the password in the **<Use a password in the SEC file>** menu.
Set or check the password after checking use.
4. Select the number of devices to be backed up at the same time in **<Maximum number of devices for concurrent backup>**.
5. Set the interval and count in **<Network Connection Retry Setting>**.
 - It specifies how many times the reconnection will be attempted and the interval (min.) when the connection to a NAS drive is cut.
6. Enter the Windows login account (configured when backing up the NAS).
7. Click the [**Apply**] button after the setup is completed.

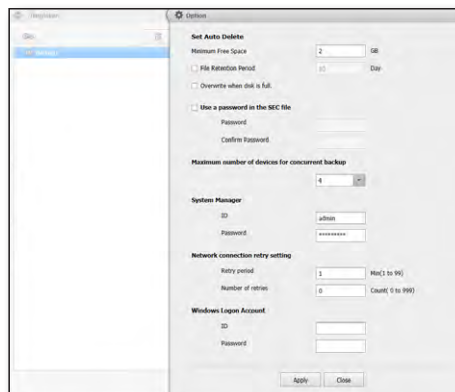

-  ▪ The following popup window is displayed if the Windows login account is not set.

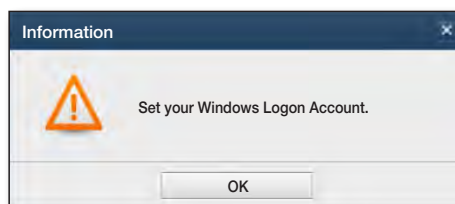

8. Configure the Configuration Manager login ID and password.
 - Only equipment assigned to the user of the ID entered is available for backup.
 - Only the ID with the scheduled backup privilege can use the scheduled backup.

Device Assignment

A device is selected and assigned to the scheduled backup.
A device can be selected to be assigned to a scheduled backup.

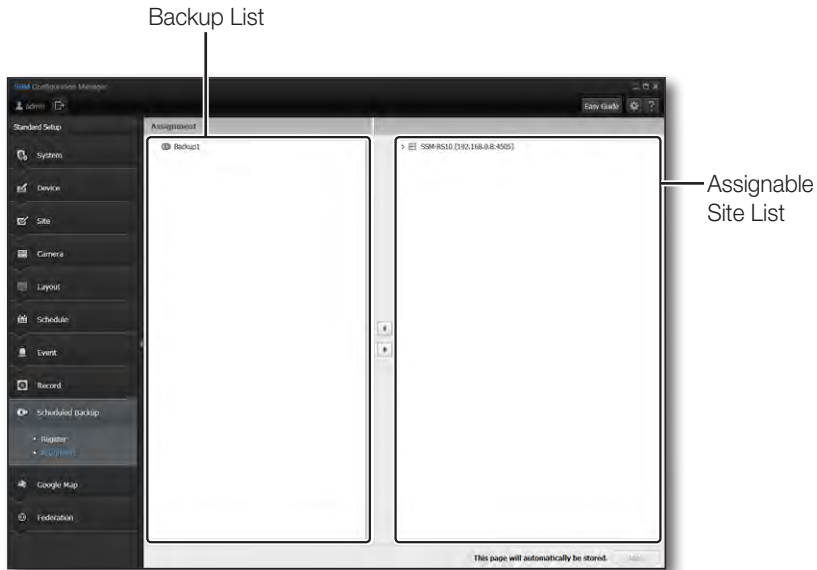

To Assign a Device

1. Select the backup schedule to assign to the camera.
 2. Click to select a device to be assigned from the device list.
 - Cameras connected to the device can also be individually assigned.
 3. Click the [◀] button.
 4. Click the [▶] button to cancel the assignment.
-  Only the devices assigned to the account set up in the scheduled backup option can be backed up.

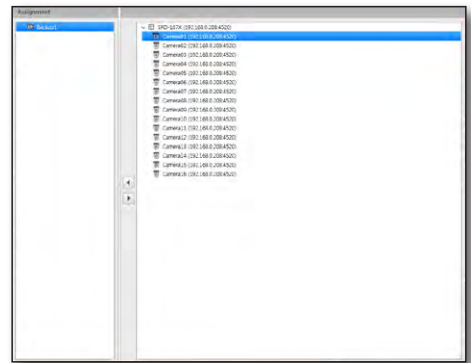

SSM configuration manager

GOOGLE MAP

Register a License

Inter-operation with Google Maps enables more efficient map utilization.

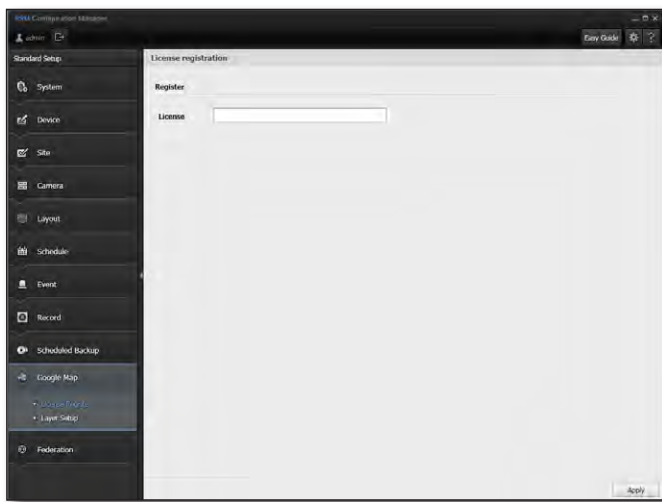

To be issued a Google Maps API key

1. Access <https://console.developers.google.com/>.
2. Log in to your Google account.
3. Create a project to use Google API.
4. Activate GoogleMaps JavaScript API.
5. Add user authentication information and select a web browser (JAVA script) at a location to which the API will be called.
6. Create an API key.

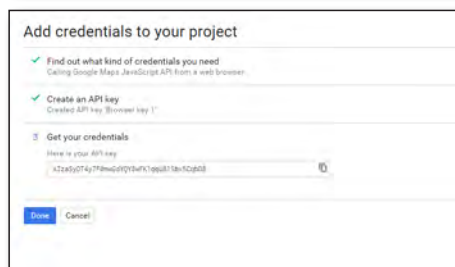
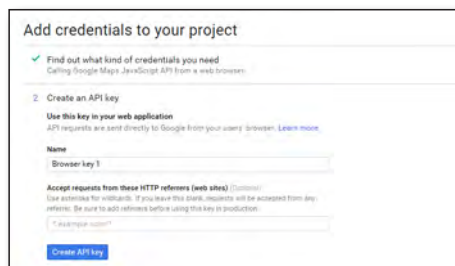

To register a Google Maps license

1. Enter the API key generated from Google.
2. Click the [Apply] button.

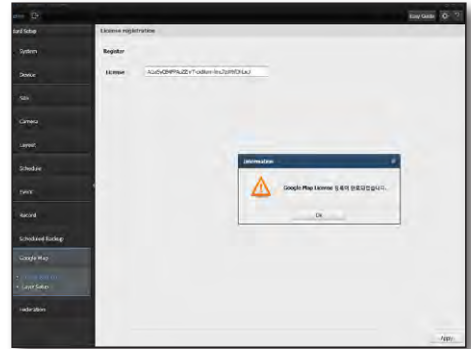

SSM configuration manager

Layer Settings

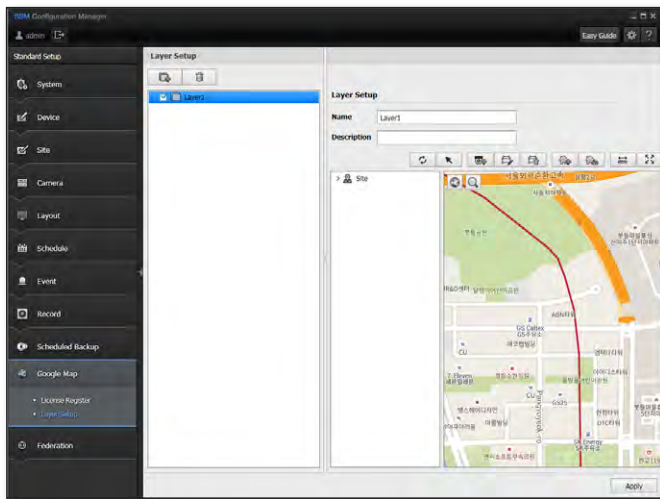

To add a layer

1. Click the [] button.
2. A new layer is added to the list.
3. In the list, click to select a layer to configure.
4. Input the name and description of the layer to configure.

To modify a layer

1. Select a layer to modify.
2. Modify the information in the desired field.
3. After you finish modifying the information, click the **[Apply]** button.

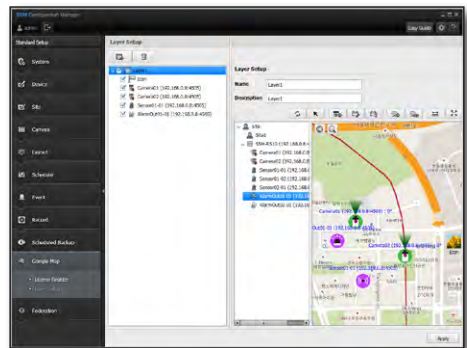

To delete a layer

1. From the list of layers, select a layer to delete.
2. Click the [] button, then click the **[OK]** on the pop-up window. After completing the deletion, click the **[Apply]** button.

Utilize the Map Layer

You can configure the settings of a camera, sensor or alarm registered in the map in detail.

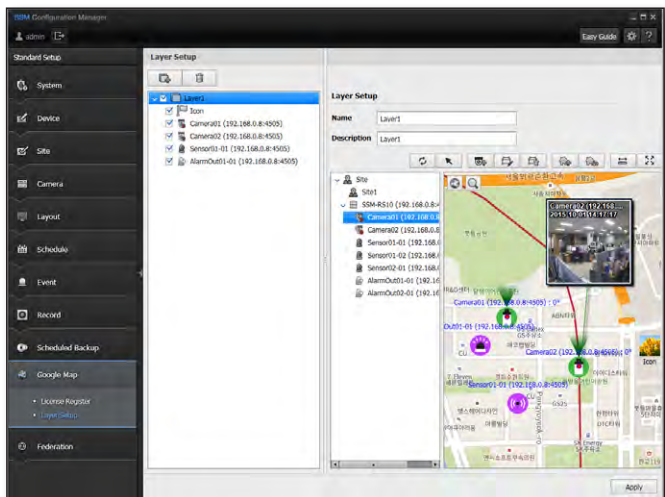

To add a device to the map

1. After you finish adding a layer, click a device to register on a device list.
 - A list of devices that can be added to the map is displayed.
2. Click and hold a camera, sensor or alarm on the list, then drag and drop it on a desired location on the map.
 - Cameras, sensor and alarms are all available for registration.
3. When you double-click the camera icon on the map, an image tile appears.



- Click and hold the camera icon, then drag and drop it to change the camera position.
- Click the device icon with the mouse. Select the red button to adjust the camera's direction as desired.
- You can scale the size of the camera icon by dragging the corner of the red box which appears when you click the camera icon.

SSM configuration manager

View a Satellite Image

When you click the [📍] button, the satellite image mode is activated. When you click the button again, it toggles back to road map mode.



Search an Address

1. Input an address you want to search, then click the [Search] button.
2. Of the addresses listed below, click the desired address to move to the corresponding map.
3. After completing the search, click the [Apply] button and click the [Cancel] button.

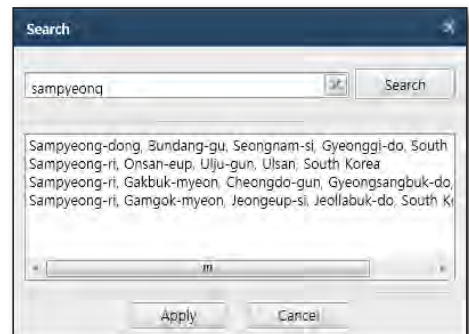

Move the Map

1. When you hover the mouse pointer over the screen, a controller to move the map appears.
2. Click one of the arrows on the controller, and then the map will move in the selected direction.
You can change the map location by clicking on the map.

To zoom the map in or out

You can zoom the current map screen in or out by adjusting the zoom bar.





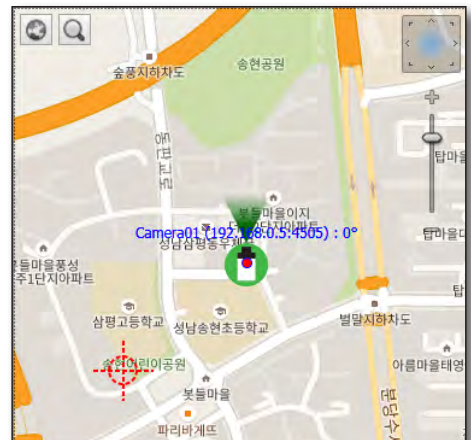



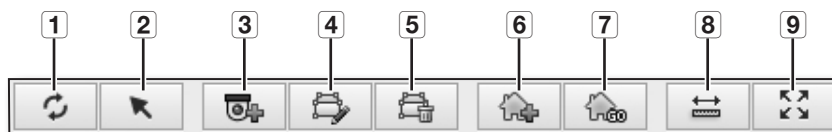

To zoom the current map screen in or out, click and hold the zoom bar then drag it. You can zoom in or out by scrolling the mouse wheel up or down.

After completing configuration, click the [Apply] button.





Use the Map Controller



Item		Description
1		This brings back what was saved the last time.
2		You can fix the map and select multiple objects.
3		On the Add an Icon window, you can configure the icon name, size, location to add an icon, color, text, etc.
4		Select the object of an icon added and click the [] button to open the settings window for the object selected. On the settings window for the object you want to modify, you can change settings for the object.
5		Select an object to delete and click the [] button to delete the object.
6		<p>You can select a location to designate as a home. The center point of the current map is displayed as the default value. Input the coordinates of a desired point to set it as a home.</p> <ul style="list-style-type: none"> By right-clicking on the home position, you can modify/delete the current home position.
7		The map moves to the home position while viewing the map.
8		On the map, click the start point with the mouse first, then click the destination point to view the distance measured between two points.
9		Shows the map in full screen mode.

SSM configuration manager

Add an Icon

1. Click the [] button.
The Add an Icon pop-up window is launched.
 - Name : Input the name of the icon to add it.
 - Icon : Import an icon to apply and resize it.
 - Latitude/longitude: Set the location of the icon to apply by inputting the latitude/longitude value.
 - Text : Configure the location, color and size of the text to be applied to the icon.
2. Click the [] button to select an icon to import.
3. Configure the size, location and text of the icon to be added.
4. After completing configuration, click the [Apply] button.

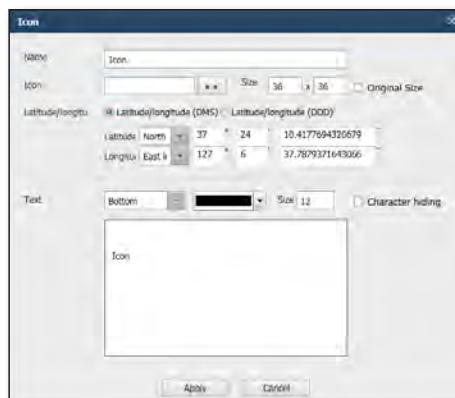

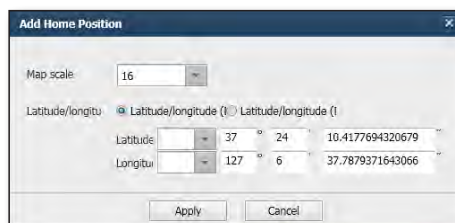

Set a Home Position

1. Click the [] button.
The Add a Home Position pop-up window is launched.
2. Input the map scale and the location of the home position.
 - By default, the center point of the current map is displayed as the home position.
3. After completing configuration, click the [Apply] button.
The home position configured is displayed on the map.



To move to the home position



If you want to move to the home position while viewing the map, click the [] button and the map will move to the home position.

- If no home position is registered, the [] button is disabled.
- After registering the home position, the [] button is disabled and the [] button is enabled.

Modify an Added Object

1. Select an object to modify.
2. Click the [] button to modify the information in a desired field to modify.
3. After you finish modifying information, click the **[Apply]** button.

Delete an Added Object

1. Select an object to delete.
 2. Click the [] button, and the selected object is deleted.
-  ▪ Alternatively, you can modify or delete the selected object by right-clicking the object.

SSM configuration manager



FEDERATION

The user of the parent site can use the equipment of the subordinate site by inter-operating two or more SSMs, which enables multi-site management.

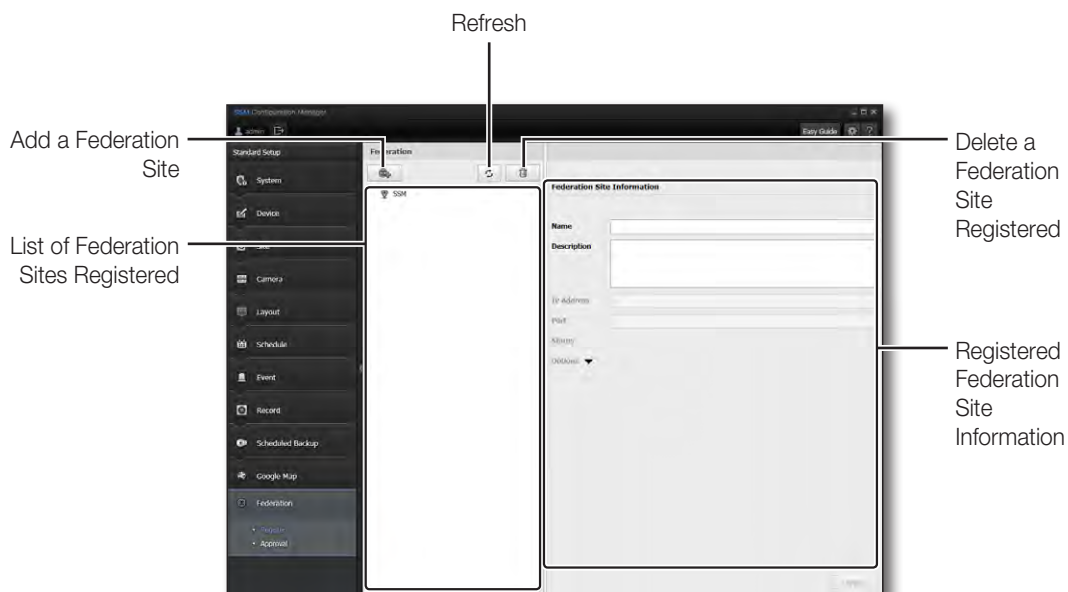
Register



To add a federation site

1. Click the [] button.
A Register a Federation Site window appears.
 2. Enter the name, descriptions, IP address and port of a site to inter-operate.
 3. Input an ID and password, then click the [Add] button.
 - If the ID and password added are correct, the federation function is activated without approval from the site added.
 - If a federation site is added without inputting an ID and password, the federation function is activated after approval from the corresponding site.
 4. After finishing registration, click the [Close] button to close the window.
 5. When the synchronization is completed after registration, the equipment information of the site added is displayed on the user group assignment page, on which you can assign or release the equipment.
-  ▪ Federation sites registered or pending are displayed on the list.

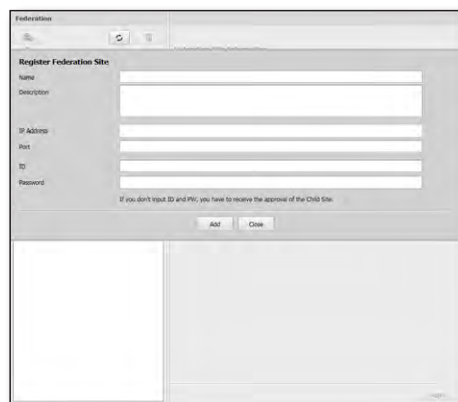

To modify the federation site information

1. Select a federation site to change the information
 2. On the right side of the screen, modify the information.
 - Click the **[Options]** button to view additional settings related to synchronization.
 3. After completing modification, click the **[Apply]** button.
-  ▪ You can't import the subordinate information to the Configuration Manager. You can only view the federation site information.

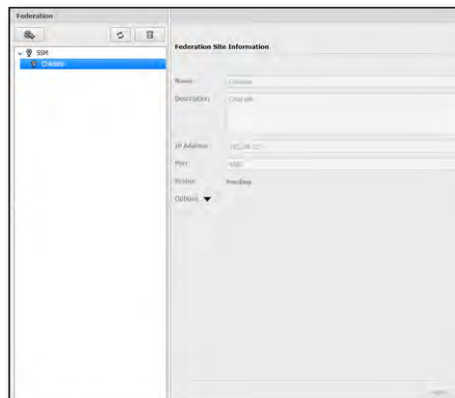

To delete a federation site

1. From the list of federation sites, select an item to delete.
2. Click the [] button, then click **[OK]** on the pop-up window.
3. After completing the deletion, click the **[Apply]** button.

SSM configuration manager

Approve

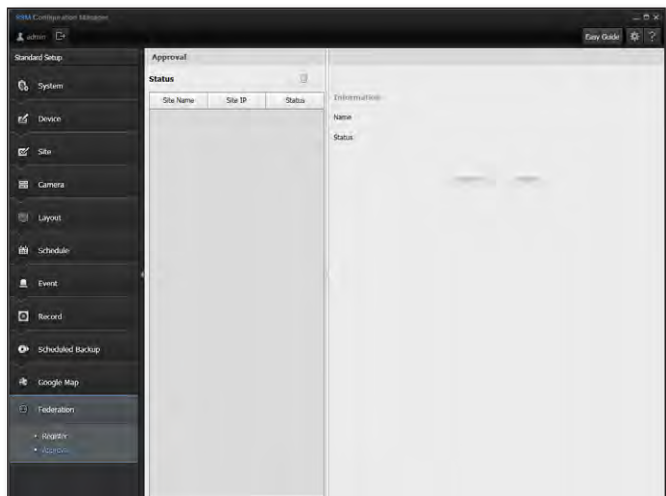

Approve an Inter-operating Site

1. On the list of inter-operating federation sites, the name and status of a site is displayed.
2. When inter-operation is requested from the parent site, the subordinate site can choose whether to accept or reject the request.
3. Click a site pending, and the information of the selected site is displayed. Change the settings of a desired field.
 - Name : Shows the site name.
 - Status : You can choose whether to accept or reject the request submitted to the site.
 - Approve : Approves the inter-operation
 - Cancel : Rejects the inter-operation
 - Event : You can select an event to share with the parent site by clicking the check box.
4. After completing configuration, click the **[Apply]** button.

Confirm Approval for a Site Whose Request Has been Rejected

1. When selecting a site whose request for inter-operation has been rejected, you can re-approve the request in the information area.
2. On the information window, select Re-approve.
3. After completing configuration, click the **[Apply]** button.

Delete an Inter-operating Site

1. On the list of federation sites, select an item to delete.
2. Click the [] button, then click **[OK]** on the pop-up window.
3. The selected site is disconnected and is deleted from the list.
4. After completing the deletion, click the **[Apply]** button.

SSM console

This is a program to monitor the camera images registered and assigned to Configuration Manager, check the event, and search the data stored in the device.

LOG IN / OUT

Logging In

Once the program is started, a user must log in for correct use of the SSM Console.

1. Click SSM Console icon.
The Login dialog should appear.
2. <LIVE>, <EVENT> and <SEARCH> viewer types are shown when viewer selection tab is clicked. Select one and log in to start the selected viewer.
3. Enter the user ID and password in the login window.
 - Default ID : admin
 - Password : Enter the password registered during the installation step.



- If SSM is installed in distributed mode and you need to start the program install in another server, click the [] button located below the login button in the login window to register the server to either <Auto> or <Manual>.
- If it is set to <Auto>, SystemManager is automatically selected. If it is set to <Manual>, SystemManager can be selected from the list, or IP and Port information can be set.

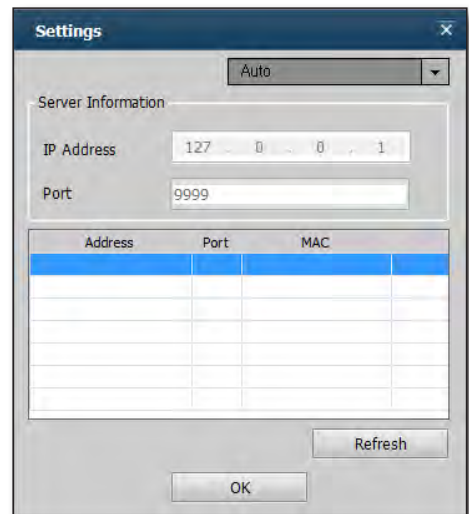

SSM console

- ✍️ ▪ Select <Save Login ID> to avoid account input from the next login.
- Set <Auto Login> in Settings to log in automatically upon starting the program.
- In the cases below, login will fail and the user will be prompted with login information.

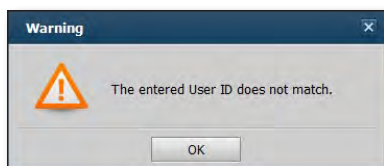

< If entered unregistered user ID >

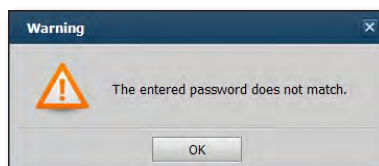

< If entered password does not match >

Logging Out

For safer use of SSM Console, please log out when the work period is finished.

Logging out saves the last screen composition and then closes all windows, and returns to the login prompt.

1. On the main window, click [] button.
The Logout dialog should appear.
2. On the dialog, click [Yes] button.
It logs out.
Terminating SSM Console automatically logs out the user.

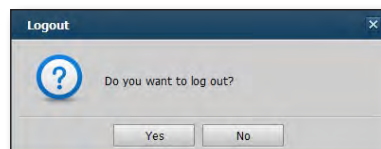

SSM CONSOLE SCREEN COMPOSITION

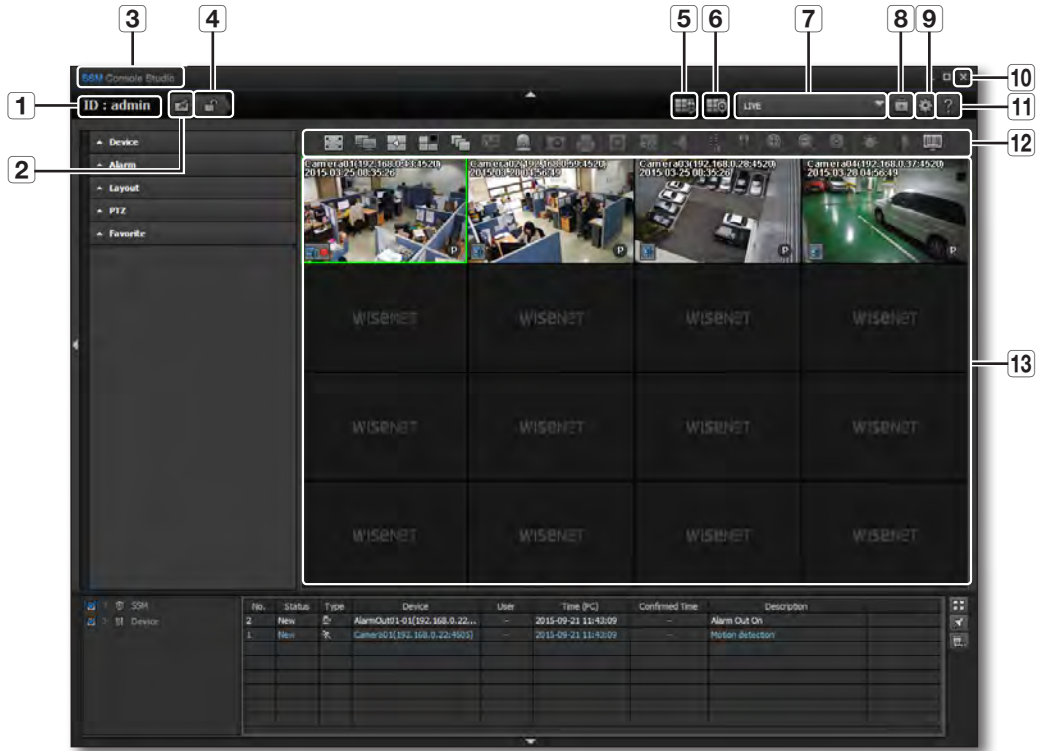

Item	Description
1	ID Shows the User ID currently logged in.
2	UI LOCK Locks the user interface. When attempted to use the program while locked, password dialog appears to unlock.
3	S/W Title Shows the software title.
4	Logout Logs out and exits.
5	Audio Broadcasting Registered cameras can be grouped for simultaneous broadcasting.

SSM console

Item	Description
6	Virtual matrix Controller Run or terminate Virtual Matrix Controller.
7	Selecting the Viewer You may select and run a desired viewer from <LIVE>, <EVENT>, <SEARCH>, <GOOGLE MAP> and <PLUGIN> or you can add a shortcut link to external program. Added external shortcut is shown in a list.
8	Check the System Status You may check the system status of computers installed with each program component.
9	Settings Opens the system settings menu screen.
10	Close Exits the program.
11	Help Shows the SSM Console application's information.
12	Menu Bar Loaded with executable menu buttons.
13	Display Pane Shows the screen according to the selected viewer.

Check the System Status

You may check the status of the computers installed with each program component.

1. Click [] on the top side of SSM Console.
2. Check each component's IP address and its status from the popped Health Check window.



- The device status in the health check window is displayed only for systems supporting SNMP.
- You can save the content of each item in a CSV file.
- Click the <Report> button at the top right of each item to select a path to save a file.

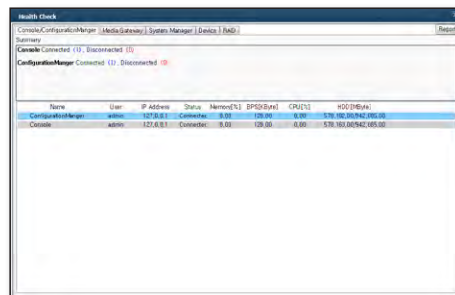

Health Check

The health check shows the summary of each item.

- Console/Configuration Manager/Media Gateway/System Manager shows the number of connected devices and the number of disconnected devices of all items.
 - IP address : IP data
 - Status : Connection status data
 - Memory : Memory utilization rate
 - BPS : Total network utilization of the PC in which the item is installed
 - CPU : CPU occupation rate
 - HDD : HDD capacity in use / Total HDD capacity
- The device shows the number of connected devices, the number of disconnected devices and the number of devices without SNMP setting.
- RAID shows the following information.
 - Number of virtual disks in normal condition (Optimal condition = normal.)
 - Number of virtual disks in abnormal condition (Partially Degraded, Degraded or Offline condition = abnormal.)
 - Number of physical disks in normal condition (Optimal condition = normal.)
 - Number of physical disks in abnormal condition (Offline, Unconfigured Good, Unconfigured Bad, Failed, Rebuild, Foreign, or Hot Spare condition = abnormal.)



- If the list of devices/RAID items exceeds 50, you can move by clicking the Previous/Next button.

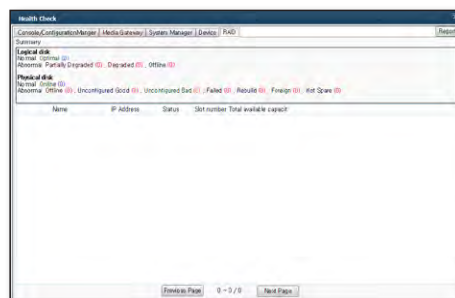

SSM console

RAID Status Checking

1. Logical disk: {Optimal, Partially Degraded, Degraded, Offline}. Optimal is the normal condition and others are the abnormal conditions.
 - Optimal : The member disk is online.
 - Offline : One or more member disks have failed, and the data cannot be accessed.
 - Degraded : One or more virtual disks set to the redundant RAID level failed, and the virtual disks cannot be maintained if there are any more errors.
 - Partially Degraded : One or more virtual disks set to the redundant RAID level failed, but the virtual disks can be maintained even if there are any more errors.
 2. Physical disk: {Unconfigured Good, Online, Failed, Rebuild, Unconfigured Bad, Foreign, Hot spare, Offline}. Online is the normal condition and others are the abnormal.
 - Online : The RAID controller can access the virtual disks.
 - Failed : The disk is a virtual disk but is no longer usable.
 - Unconfigured Good : The RAID controller can access the disk, but the disk is not a virtual disk.
 - Unconfigured Bad : The disk failed but is replaced by the hot-spare disk and thus is no longer a virtual disk.
 - Rebuild : This disk is used to restore the redundancy of a virtual disk.
 - Foreign : A disk is displayed as foreign until the user changes its configuration after it is added to another RAID controller.
 - Hot spare : The disk is set to hot-spare.
 - Offline : The disk is a virtual disk and displayed in invalid data. It may be in the middle of a status change.
-  ■ RAID data are displayed only for the recording servers installed in a PC/server using the RAID controller supplied by Intel/LSI.

Help

Click Help button to display program version and date information window.

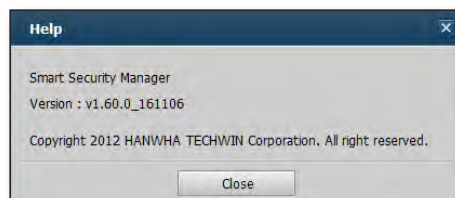

Checking up Console Configurations

The console program is comprised of Live/Event/Search/Google Map/Plug-in Viewer. Understand the role of each component and run the appropriate one as required.

Console Structure

- Live Viewer : Provides real-time video and event information for monitoring, as well as PTZ control interface.
- Event Viewer : Provides viewing of real-time events and the searching / playing of device's events.

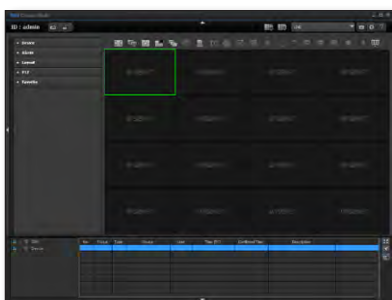

< Live Viewer >

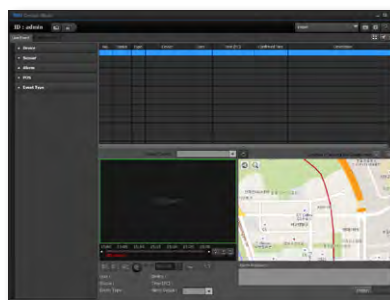

< Event Viewer >

- Search Viewer : You can search and play video footage stored in your local computer or in the device.
- Google Map Viewer : Registers and configures the settings for equipment through inter-operation with Google Maps Viewer to control real-time video monitoring, event reception, etc.

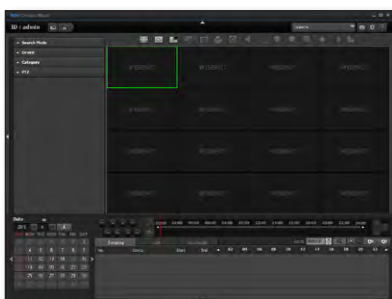

< Search Viewer >

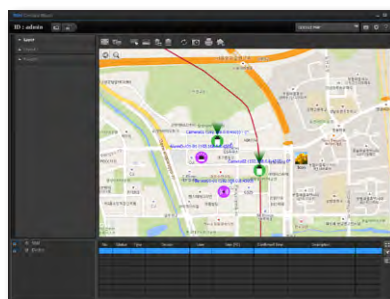

< Google Map Viewer >

- Plug-in Viewer: You can register a plug-in in the <Plug-in> folder to run the viewer.

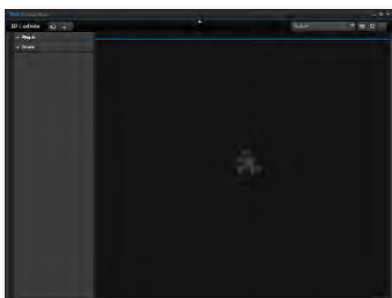

< Plug-in Viewer >

live viewer

Provides real-time video and event information for monitoring, as well as PTZ control interface. Select **[LIVE]** menu of the viewer selection tab on the top right side of SSM Console. Initially, SSM Console's default viewer is set to the Live Viewer.

NAMES AND FUNCTIONS OF LIVE VIEWER

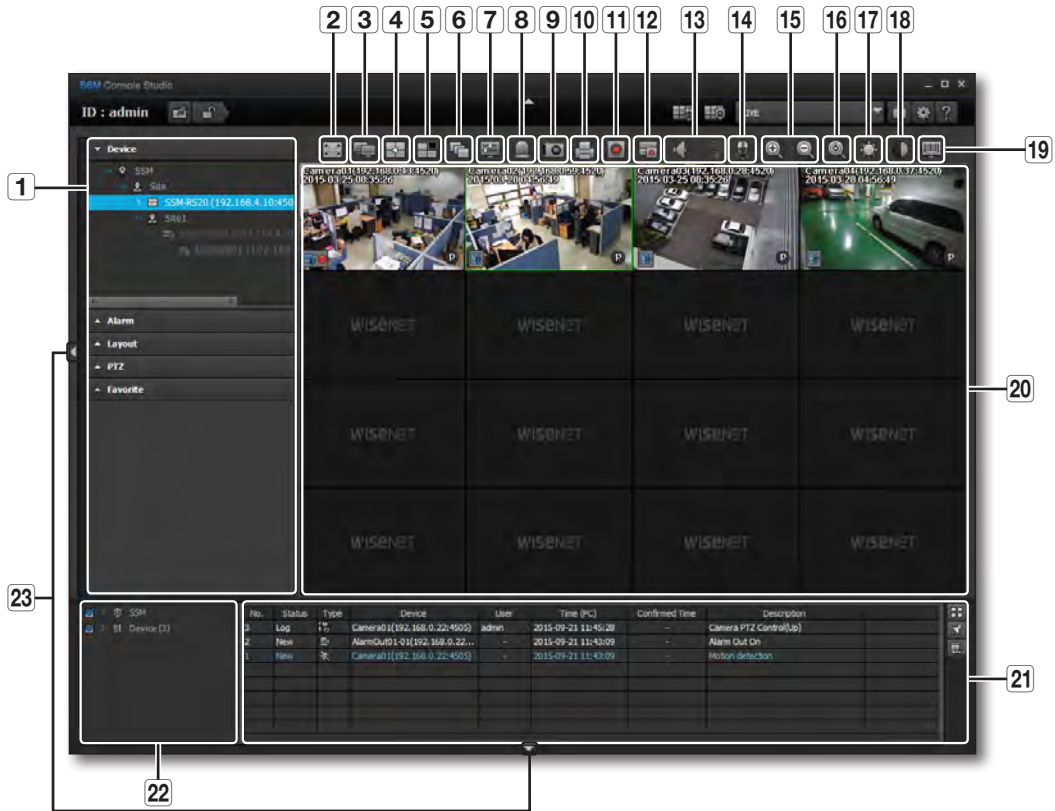

Item	Description
1	List Menu Shows registered devices and their connection status.
2	Full Screen Fills the monitor's full area with video screen.
3	Multi Monitor Enables expanded monitor configuration for monitoring.
4	Change Tile Pattern Selects the split screen mode of the live viewer's video area.
5	Deletes the video tile. Deletes all open video tiles.
6	Sequence Screen switches its display layout mode automatically in order and interval defined in "Settings > Screen > Monitor > Sequence".

Item	Description
7	OSD On/Off Show or hide displayed indicators.
8	Initialize Events Clears out all event indicators from all video tiles.
9	Capture Saves the entire split screen windows.
10	Print Prints the entire split screen windows.
11	Record Starts or stops recording of the selected video tile.
12	Device REC Starts or stops recording with connected device remotely.
13	Speaker Turns on or off the speaker.
	Volume Adjusts audio volume.
14	Talk If supported by the connected device, activates microphone to talk.
15	Zoom In/Out Enlarges or reduces video size using digital zoom.
16	Original Size Resizes zoomed screen to its original 100% size.
17	Brightness Adjusts the current video tile's brightness.
18	Contrast Adjusts the current video tile's contrast.
19	View Receipt Turns the receipt information of the POS device connected On or Off.
20	Display Pane Shows the Live Viewer screen.
21	Event List Shows events occurred on connected devices.
22	Event Filter You can select event types to be displayed on the event list.
23	Show/Hide Tools Use these buttons to show or hide menu pane and control buttons.

Camera status indicator

Indicators shown on the video tile tells the connected camera's input status.



< Video Loss >

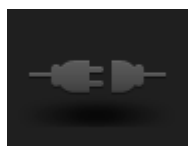

< Disconnected >



< Exceeded max user >



< Camera Off or Covert >









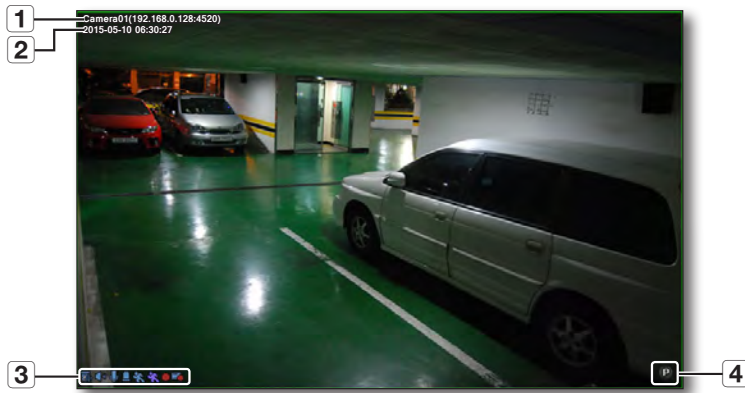

< Disconnected state >

live viewer

NAMES AND FEATURES OF SCREEN INDICATORS



Item		Description
1	Camera Name	Shows the name and IP address of camera connected to the corresponding video tile. If <Use Device's Default Name> is set, the name registered to the device is shown as the camera name.
2	Date & Time	Shows the video's date and time information.
3	Icon	 Shows the device supports PTZ control.
		 Display the status of audio output.
		 Display the status of using the microphone.
		 Appears when a sensor event is generated.
		 Appears if motion event is detected by the corresponding camera.
		 Appears if a video analysis event has occurred on the corresponding camera.
		 Appears if audio event is detected by the corresponding camera.
		 Shows that recording is in progress on the computer running SSM Console.
		 Shows that recording is in progress on a remotely connected device.
4	Live Playback	<p>When the video is selected, a live playback button is displayed at the bottom right of the video screen. In <Event pre playback time (Seconds)> under "Setup > Event > Playback time for event" the recorded video goes backwards by a specified period of time in seconds then is played automatically in a forward direction.</p> <ul style="list-style-type: none"> Multi-channel Playback Function: When switched to playback mode, you can play back the video by selecting a different channel.

DEVICE

Add a networked device and allocate a registered camera to the user's device list. Select the device to view the in a tile.

In registration step, set to **<Connect>** to display the device in the list as connected.

Connecting Devices

1. Select a site to monitor.
2. Select a device to be connected to.
3. Right mouse click on it.
Upon the context menu, select **<Connect>**.



- For further information on adding devices, refer to "**Device > Register**". (Page 38)
- If logged out while connected to a device, logging in again revives previously connected devices and groups automatically.
- If you select a list and enter text (keyword), only those groups and devices that contain the text will be displayed in the search result. This is useful if you do the search for a long list of devices or groups.

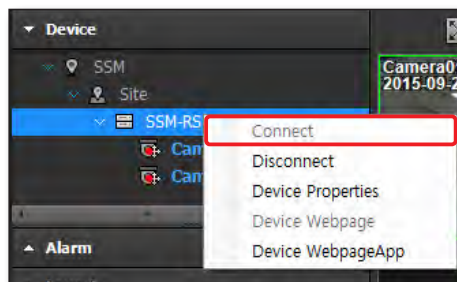

Disconnecting Devices

1. Select a device to be disconnected.
2. Right mouse click on it.
Upon the context menu, select **<Disconnect>**.

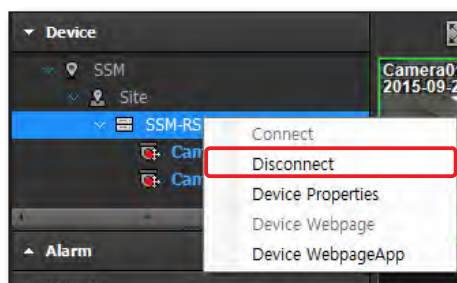

live viewer

Device Properties

1. Select a device.
2. Right mouse click on it.
Upon the context menu, select **<Device Properties>**.
3. Check the device information.

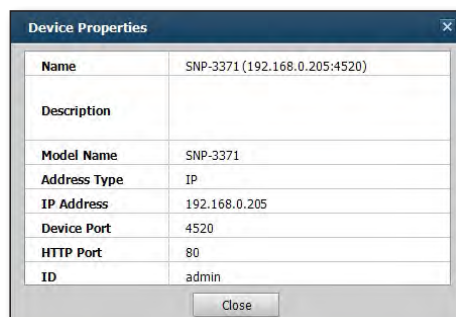

Device Webpage

Runs the device on a web viewer.

1. Select a device.
2. Right mouse click on it.
Upon the context menu, select **<Device Webpage>**.
3. Enter the access information to the device, ID and password.
4. Moves to the connected device's web viewer starter page.

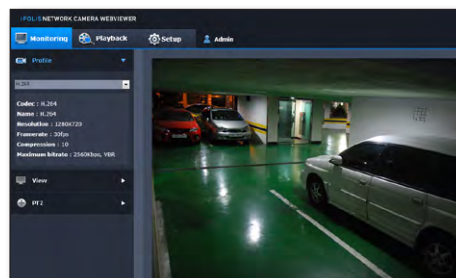

Device WebpageApp

Runs the device on the mobile app.

1. Select a device.
2. Right-click on the device.
When the contextual menu appears, click <Device WebpageApp>.
3. The list of apps installed on the device is displayed.
4. Select an app from the app list, and the website of the selected app is opened.

Device Context Menu

Right mouse click on an empty area within the device list to open device context menu.

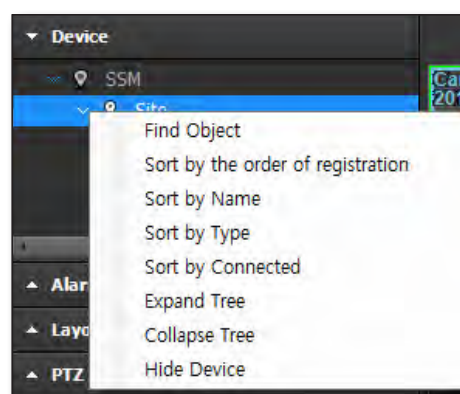

Find Objects

You may find a device by name from the registered devices.

1. From the context menu, select **<Find Object>**.
2. Once the Find Object window appears, select the searching direction.
3. Enter the keyword for name and click **[Next]** button.

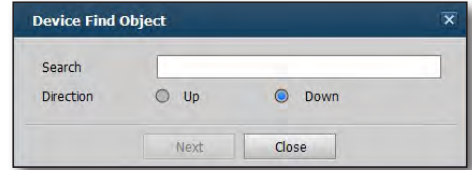

- **[Ctrl]+[F]** also brings the find object window.
- Find object opens only when the object tree has the focus (highlighted).
- The **[Next]** button is activated only if a keyword exists.

Sort by the order of registration

Click **<Sort by the order of registration>** in the contextual menu, and then the devices registered are sorted in the order of date of registration.

Sort by Name

From the context menu, select **<Sort by Name>** to sort devices by name.

Sort by Type

From the context menu, select **<Sort by Type>** to sort devices by type, while the device tree collapses.

Sort by Connected

From the context menu, select **<Sort by Connected>** to sort devices by the order of connection establishment.

Expand / Collapse Tree

From the context menu, select **<Expand Tree>** or **<Collapse Tree>** to show or hide tree list of registered devices.

Show / Hide Devices

From the context menu, select **<Hide Device>** to hide registered devices.









If hidden, the menu switches to **<Show Device>** automatically, and selecting it reveals the hidden devices.

CAMERA LIST

If connecting to the device was successful, a list of connected cameras appears.

Camera Indicators

Indicators that appear by each camera in the list show the camera's status information.

-  : General camera
-  : Camera supports PTZ control
-  : In recording
-  : Camera disconnected by a user
-  : Camera is disconnected / unreachable
-  : Box Type
-  : PT Driver Type
-  : Fish-Eye/Panomorph Type



Refer to "Camera Info View" for details of camera type selection. (page 49)

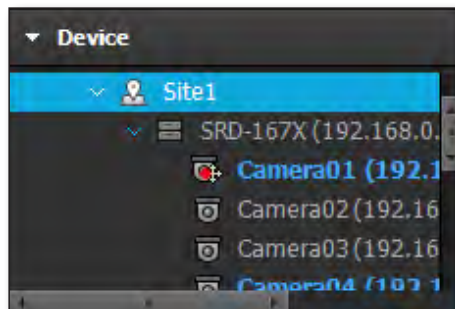

Camera Context Menu

From the device list, select a camera and right click on it to open the camera context menu.

Locate Tile

Highlights the selected camera's video tile.

Add Video

Selected camera's video is displayed on an unoccupied tile.

Remove Tile

Select a camera and open context menu to select <Remove Tile> to remove the corresponding tile.

Camera Properties

Select a camera and open context menu to select <Camera Properties> to display the camera's properties.

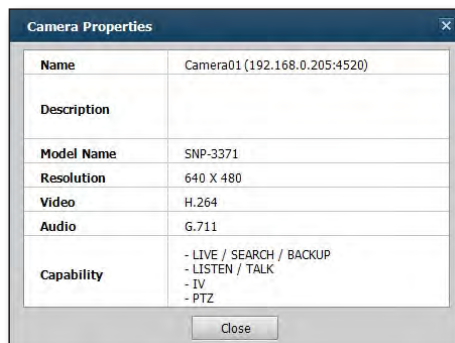
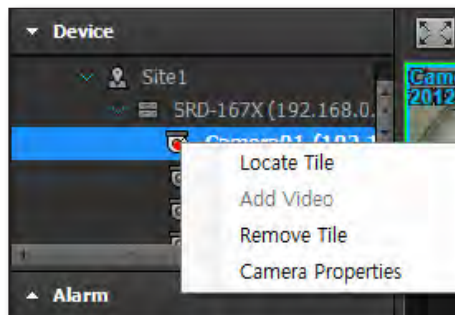

ALARM OUT AND CONTROL

Once a device's connection is established successfully, the device appears in the Alarm Out list. You may turn on or off each device's alarm.

Alarm Out Context Menu

Select an alarm and right click on it to open its context menu that enables alarm control.

Turning On Alarm Out

Select an alarm and open context menu to select **<Alarm Out On>** to turn on the selected alarm's alarm output.

Turning Off Alarm Out

Select an alarm and open context menu to select **<Alarm Out Off>** to turn off the selected alarm's alarm output.

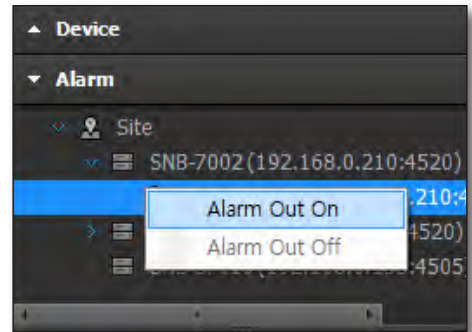
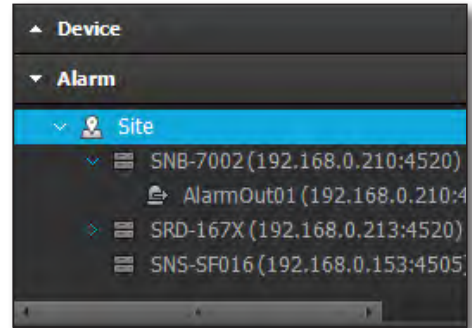

Turning On / Off Alarm Beep

For devices supporting Alarm beep speaker, **<Alarm Beep On>** or **<Alarm Beep Off>** menu appears.

Upon such device's alarms, you can turn on or off beep sound output.

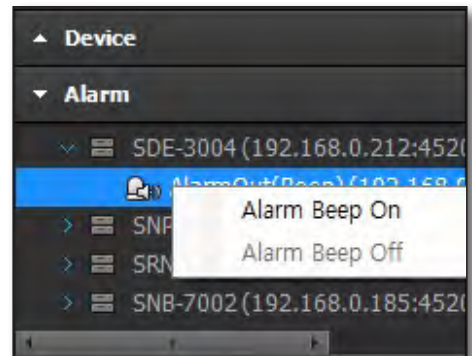

SELECTING TILE PATTERN

You can set the video pane's split-screen mode.

- 4:3 screen modes : 1/4/6/8/9/10/12/13/16/17/21/25/36/49/64



- 16:9 screen modes : 6/12/20/30



- While in multi-monitor environment, layouts and split modes for less than 100 channels will be available. Other modes will be disabled.
- Modes having more splits than the number defined in **<Split Screen>** will be disabled. (Page 190)

LAYOUT

You can configure SSM software to display in multiple monitoring devices with defined layout.

From the top side menu, select [] button then select a desired multi monitor type, and configure the layout as preferred on the expanded monitor.

Apply a layout for the multi monitors

Selecting the multi monitors

1. From the top side menu, click [] button.
2. Select the number of monitors.
As many monitors as specified are displayed on the screen.
3. Select a monitor to be applied with the layout settings by clicking arrows beside the monitor name.

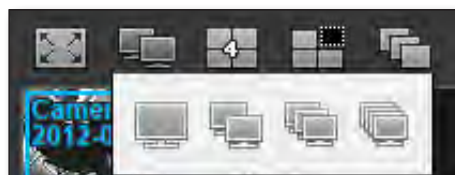

live viewer



- Monitor #1 is the default monitor, and Monitor #2 and others are expanded monitors.
- You can set expanded monitor in "**Screen > Monitor**". (Page 190)
- The extended monitor (subsidiary Live Viewer) is applied to the monitor specified in "**Screen > Monitor**". Full screen is also applied to the specified monitor.
- Since the monitor 1 is set to the extended monitor by default, the monitor setting must be changed to change the location of the extended monitor execution.



Setting the Tile Pattern for the expansion monitor

1. Click a tile of an expansion monitor to activate the corresponding monitor.
2. From the top side menu, click [] button.
3. Select a desired tile pattern to apply it.

Use Expanded Monitor Menu

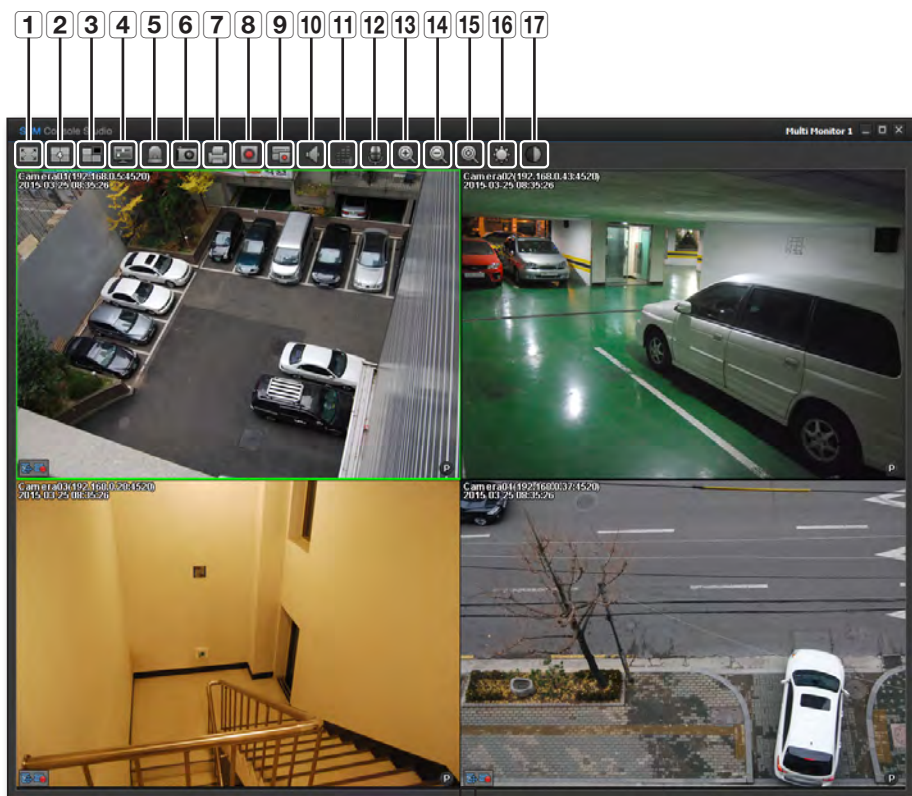

Item	Description
1	Full Screen Expands the video screen to the full screen size
2	Change the Tile Pattern Selects the split screen.
3	Delete a Video Window Deletes the full-size video window.
4	Turn OSD On/Off Selects whether to turn the OSD information On or Off in the full-sized video window
5	Initialize Events Turns off the event indicator displayed in the video window
6	Save the Screen Saves the full-size split window image in a .jpeg file format

live viewer

Item	Description
7	Print Screen Prints the full-size split window image
8	Record Starts/Stops recording the video of the selected channel.
9	DVR Recording Starts/Stops recording the videos of all channels.
10	Speaker You can hear the sound from the selected video.
11	Volume Controls the volume of the selected video using the Up/Down button.
12	Speak Delivers a sound to the selected video.
13	Zoom In Increases the digital zoom.
14	Zoom Out Decreases the digital zoom.
15	Original Size Returns to the default value of the digital zoom.
16	Brightness Adjusts the brightness of a video.
17	Contrast Adjusts the contrast of a video.

Applying Layout

Select a monitor and then double click the desired layout.
The selected monitor is applied with the layout.

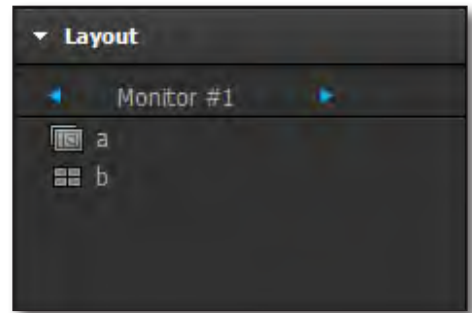

To add a layout

You can add multiple layouts to a desired monitor.

The layout can be registered in "**Layout > Register**" of SSM Configuration Manager.

For further information on adding layouts, refer to "**Layout Setting**". (Page 66)

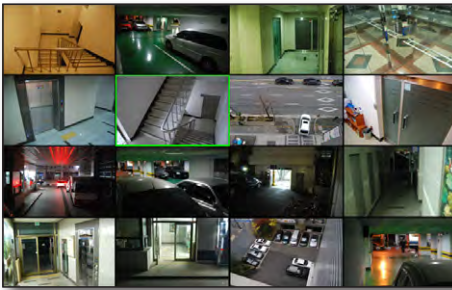

< Camera Layout >



< Map Layout >

live viewer

Favorites

The camera layout of the selected monitor can be added to Favorite (32 Korean characters or 64 letters).

- The Favorites are stored separately for each user.

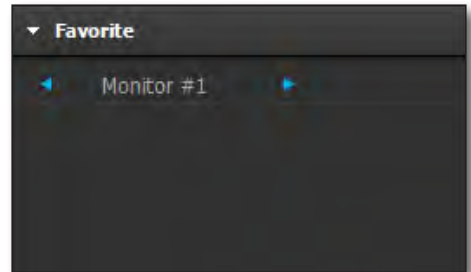

Using Map Layout

Selecting Split View Mode for Map Layout

When selecting a Map Layout, up to 10 split view modes are available for the corresponding.



Utilizing the Map Layout

In the split view mode, a desired layout can be applied quickly.

- The Free mode places the video right upon the camera icon when the icon on the map layout is clicked.
- The other 9 modes place the camera's video on the first unoccupied tile when clicked the camera icon.
- To delete the selected video, press the **[Delete]** key on the keyboard.
- Map tile link line : When a camera icon or image window is clicked, the image window and camera are connected by a line.
- Icon tool tip : Place the mouse pointer on a camera icon on the map layout to display the description input in **"Device > Register"** of Configuration Manager.

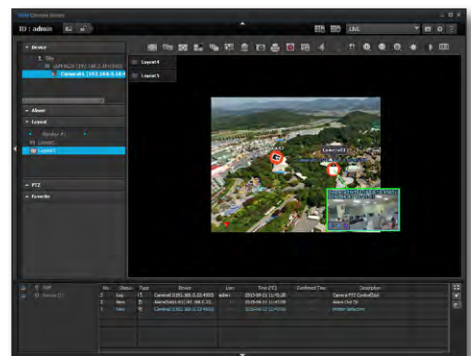

- Mini map : Double click the Map Link button or layout group link to display the mini map page.
- To exit Map Layout mode, click [] button.
- If you select a layout group in the layout tree, the first map that belongs to it will be displayed. Also, the screen will display the button you can press to move to the map that belongs to the group.
- Camera
 - Tile search : It finds the tile showing the camera image.
 - Tile delete : It deletes the tile showing the camera image.
 - Attribute : It shows the information of the connected camera.
 - Instant Player : It runs the Instant Player.
- Alarm Out
 - Alarm Out On : It turns on the alarm output setting.
 - Alarm Out Off : It turns off the alarm output setting.

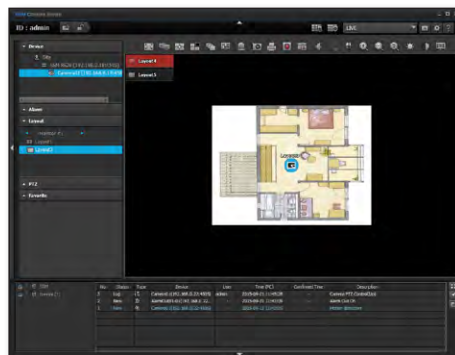

To initialize the angle

Click on the [] button and then the Move to Map button to initialize the angle.



- Refer to "**Layout Setting**" for more details of layout. (Page 66)
- Refer to "**OSD Display**" for further information on setting the mini map. (Page 191)

To move around the map

- While holding down the mouse's right click, move your mouse to change the map angle.
While holding down the mouse's left click, move your mouse to change the map location.



live viewer

- Press the 'Shift' key and drag the mouse to draw a rectangle and select all camera icons within the rectangle. Drag the selected icons to the map to display the image tiles of the selected cameras on the map, to the multi-monitor to display the images of the selected camera, and to the view matrix setting screen to set the selected cameras in the view matrix.

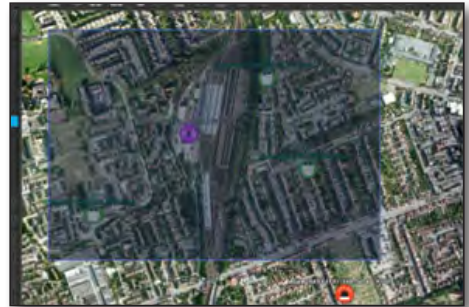

- If the mini map is checked in the console setup, the mini map is displayed when the Map Link / Layout Group Link icon is double clicked.

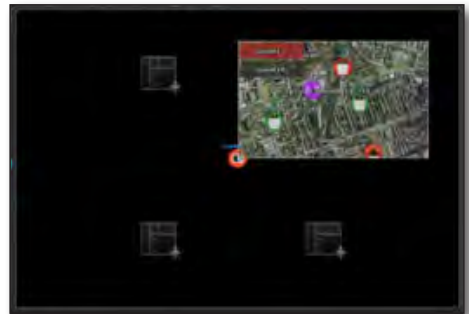

To zoom in/out

Use zoom control bar to zoom in/out the current map screen. To zoom in/out, click the control bar in the middle and drag. Mouse wheel button zooms in/out the map too.

- When the image tile on the map is double clicked, the size is changed in the sequence of 1X, 2X, 3X → 1X, 2X



Play Instant Viewer (Playback)

The camera icon on the map layout blinks if an event occurs. Double click the camera icon to display "Instant Viewer(Playback)".

It enables checking the event and digital zooming on the video screen.



- For further information on using the Instant Viewer, refer to "Instant Viewer". (Page 136)

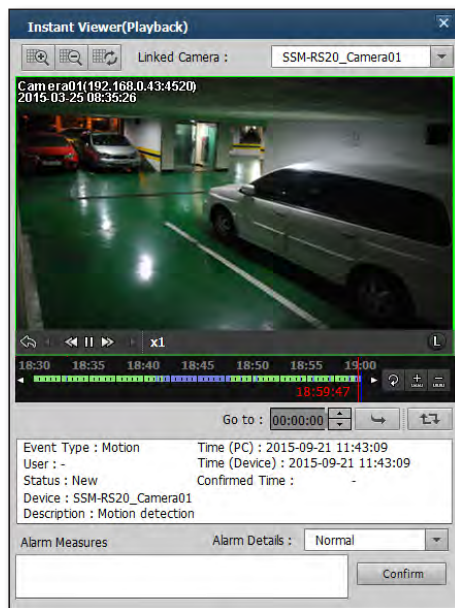





VIRTUAL MATRIX CONTROLLER

Virtual Matrix Controller is used to control the SVM (Smart Virtual Matrix) S/W and it requires installation of the SVM. Virtual Matrix Controller can only retrieve the settings in the SVM and apply or edit them. It cannot save the modifications. If you want to save the changed settings, you need to use the SVM.







1. Click on the [] button in the top of the SSM Console screen.
2. In the right hand side of the video window, the Virtual Matrix control screen will be displayed.

Functions of the monitor layout viewer button

-  : Returns to the mode previous to wall spot.
-  : Loads the video displayed on the wall monitor into the program.
-  /  : It starts or stops the Advanced Wall Layout mode when the Wall Layout is selected.

It starts or stops the Wall Sequence/Wall Spot when the Wall Sequence/Wall Spot is selected.

- Advanced Wall Layout mode : This refers to changing the monitor layout, monitor sequence, tile spot and monitor spot in the wall layout to be in a run ready condition.

-  : Removes the event displays from the selected tile.
-  : Removes the event displays from the selected monitor.
-  : Changes the monitor layout pattern.
-  : Deletes the displayed content from the selected tile.
-  : Deletes the displayed content from all the tiles.
-  : Reverts to the last saved monitor layout.



- A tile is a single unit of video displayed in the monitor.
- While editing the monitor layout, if you want to work on another monitor layout, then click on it to move to it immediately.
- The information display window in the bottom of the monitor layout will display the <Wall Layout> if you click on it and will display the <Monitor Layout> if you click on it.

To apply a Wall Layout

1. Select a registered wall.
2. Set the wall mode to Wall Layout.
3. Select a wall layout to use.
The wall layout will be immediately applied to the wall.
4. The selected Wall Layout name will be displayed.

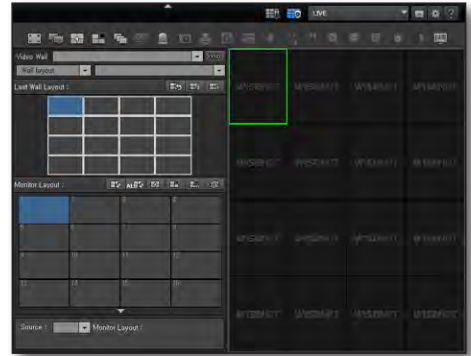

To edit the Monitor Layout

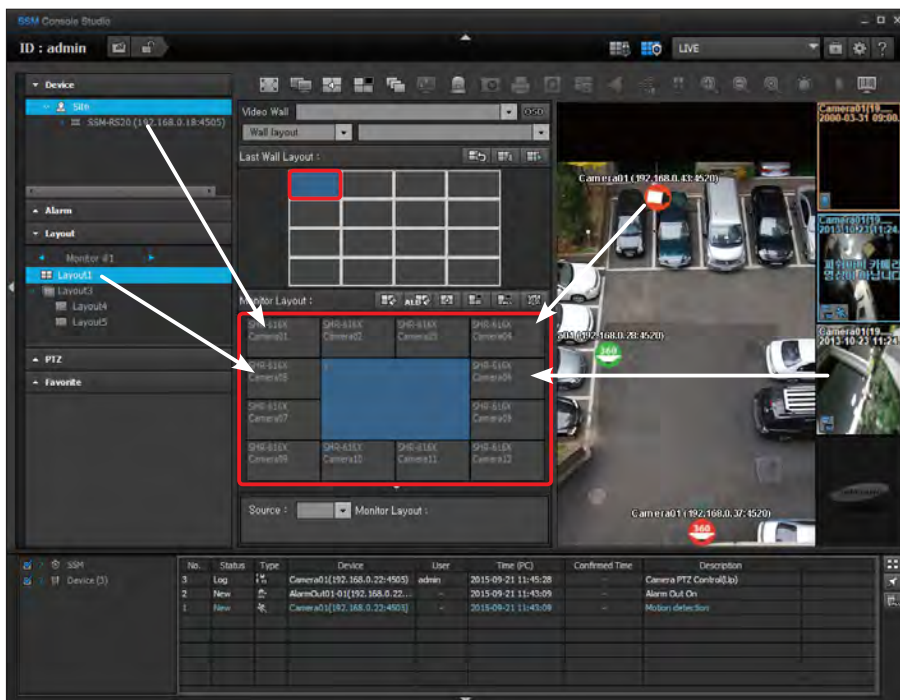

1. Double click a tile in the wall layout to display the information of the selected tile.
 - The information of the selected tile : Monitor layout, map layout, monitor sequence, tile spot and monitor spot data are displayed. Although the monitor layout data include the details of the layout, other items only display the object name.
2. Drag and drop the device/layout/map icon/live video to the monitor layout. It will be reflected in the wall on a real time basis.
 - Video that can be assigned by dragging and dropping
 - Drag a device and assign it to the monitor layout
 - Drag a layout and assign it to the monitor layout
 - Drag an event and assign it to the monitor layout
 - Drag the icons in the map layout to allocate them to monitor layout. (Multiple icons can be selected using the <Shift> key.)
 - Drag video played in the SSM and assign it to the monitor layout
3. However, it is not reflected on the wall right away if the wall mode is active.

live viewer

To run a wall sequence

A wall sequence is a function to shift multiple wall layouts in order to view multiple layouts on a single wall.

1. Select the wall mode to Wall Sequence.
2. Select a specific wall sequence from the wall sequence list.
3. If you press it once, a wall sequence will appear. Press it one more time to terminate it.



To Run Wall Spot

The wall spot is a function to change the wall image when an event is generated in a device. A spot is a function to change the wall video when an event occurs on a specific device.

1. Select the wall mode to Wall Spot.
The wall spot added in SVM is displayed.
2. Select a wall spot from the wall spot list.
3. Click once to start the wall spot and click again to stop the wall spot.

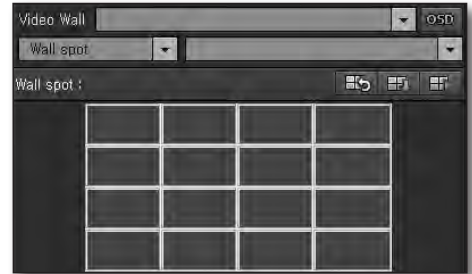

If you want to set the OSD on the wall

Set the OSD to be displayed on the video wall.

1. Click on the [OSD] button.
The OSD settings screen will be displayed.
2. Select an OSD item to be displayed in the video.
3. Click on the [OK] button after settings are completed.
Click on the [Cancel] button to return to the previous screen.

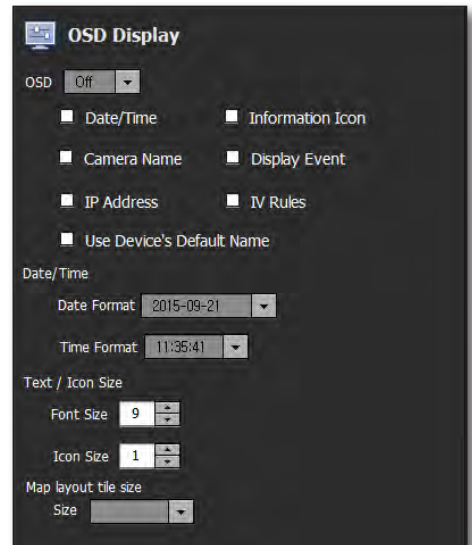

AUDIO BROADCASTING

To Add/Delete an Audio Broadcasting Group

A broadcasting group can be added and a camera can be registered for audio broadcasting.

1. Click the right mouse button on an audio broadcasting group and select **<Add Broadcasting Group>**.
2. Enter the name in the name input box and click the **<OK>** button.
 - The name can be changed after the broadcasting group is added.
3. Register a camera by dragging and dropping under the added broadcasting group.
 - There is no limitation on the number of broadcasting groups to be added, but up to 16 cameras can be registered.
4. To delete an added item, select the item and right click the mouse and select **<Delete Item>**.

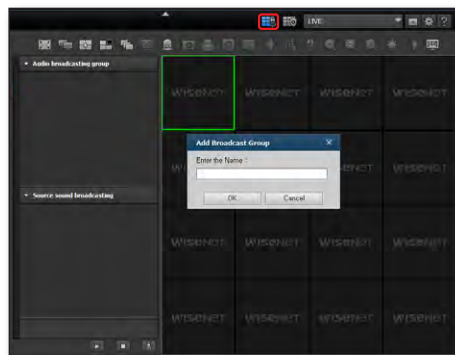



To Add/Delete the Source of Audio Broadcasting

The sound files in the PC can be selected for broadcasting.

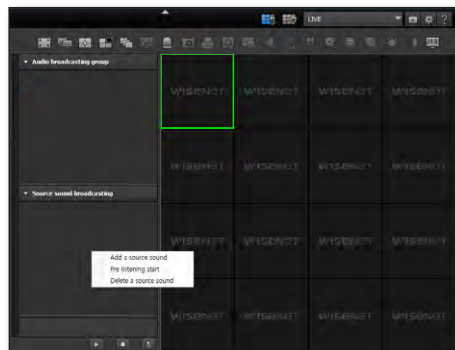
1. Select 'Audio Broadcasting', right click the mouse and then select **<Add Sound Source>**.
2. Select a sound file to add.
 - Only mp3 and wav format sound files are supported.
3. Right click the mouse to preview or stop preview of the added sound file.
4. To delete an added sound file, select the file and click the right mouse button then select **<Delete Sound Source>**.



- The registered cameras can be grouped for simultaneous broadcasting.

- 
 - User's voice can be transmitted using [].
 - Up to 16 cameras can be selected at once for broadcasting.

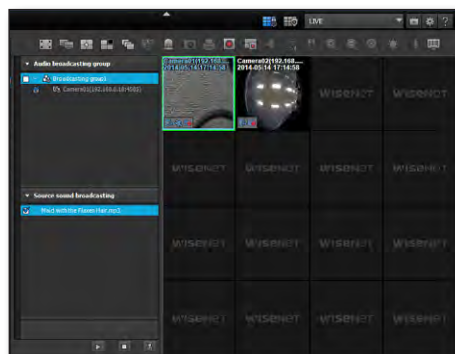

PTZ CONTROL

If the connected device supports PTZ functions, you can control PTZ camera remotely.



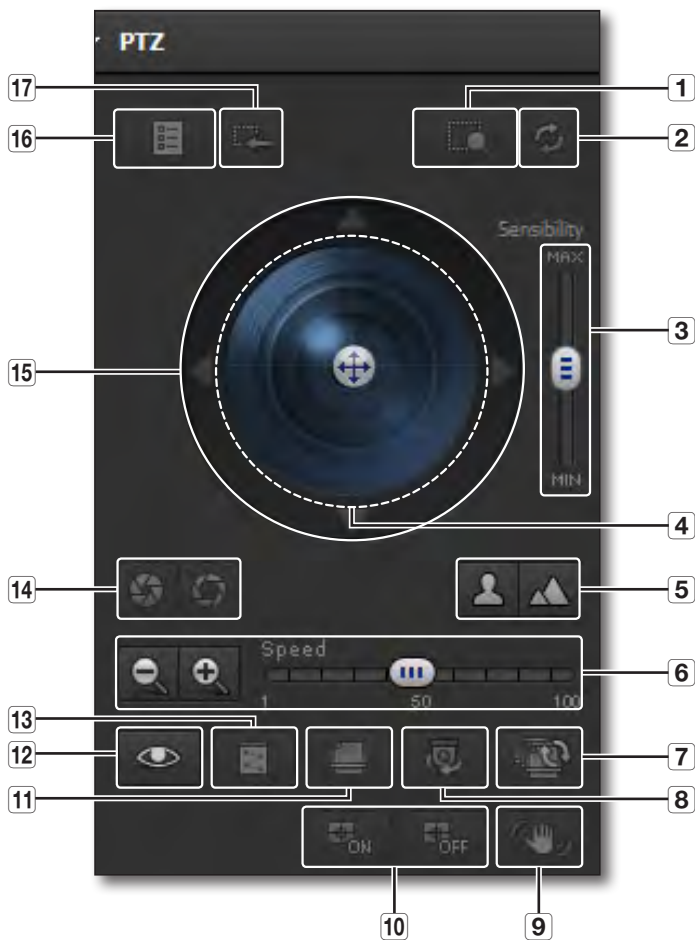

- Even the box cameras without the PTZ function can use some function of <Panomorph Lens> or <Fish-Eye>.
- Depending on camera model used, PTZ control may not be supported. For further information, refer to the camera's user manual.
- If the camera supports Fish-Eye or SUNAPI, the home position can be set.
- Select the PTZ camera and click the arrow key to move the PTZ camera in the selected direction.

Names and Functions of PTZ Control Window



Item	Description
1 Area Zoom	Controls PTZ to fill in tile with the dragged area on the video.
2 Go to 1x Zoom	Restores the original 1x zoom from Area Zoom screen.
3 PTZ Sensitivity Controller	Adjusts the PTZ ball control sensitivity to faster or slower.
4 PTZ Ball	While operating PTZ, click and hold the ball and drag to desired direction to adjust the camera's framing.
5 Focus Adjustment	Adjusts the camera's focus manually. <ul style="list-style-type: none"> ▪ Focus Near : Adjusts the focus range to closer distance. ▪ Focus Far : Adjusts the focus range to farther distance.
6 Zoom Adjustment	Zooms in / out with controllable zooming speed. Zooming activates only if clicked at the speed set by speed slider. <ul style="list-style-type: none"> ▪ Zoom Speed Slider : Sets the zooming speed out of 1 – 100 range. ▪ Zoom In : Zooms in to enlarge the image. ▪ Zoom Out : Zooms out to reduce the image.
7 Tour	This is to call a group and its presets in order for monitoring.
8 Swing/Autopan	Sets the camera to repeat swinging from a certain position to another. According to the configuration, you can set to rotate or swing. You can only activate or deactivate <Autopan> option of the camera.
9 DIS On/Off	DIS function can be turned on or off.
10 Auto Tracking On/Off	It is possible to turn the Digital Auto Tracking/Auto Tracking functions on or off.
11 Group/Scan	Controls the camera according to the added preset groups in order, where a preset group can be of multiple presets. You can only activate or deactivate <Scan> option of the camera.
12 Trace/Pattern	Moves and zooms the camera with a predefined settings automatically. You can only activate or deactivate <Pattern> option of the camera.
13 Preset	You can save specific camera's view as a preset, or recall a preset to set camera framing.
14 Iris Control	Controls the amount of light travels through the lens. <ul style="list-style-type: none"> ▪ Close Iris : Sets to bigger F number for less light exposure, resulting in darker image. ▪ Open Iris : Sets to smaller F number for more light exposure, resulting in brighter image.
15 Camera Menu Traversal	While opening the camera menu, adjust the selected position.
16 Switch to the Menu Mode	Moves to the connected camera's settings menu screen.
17 Exit the Menu Mode	Exits the menu setup.

Auto Tracking

1. Click [] to run auto tracking.
 2. Press <Alt> key to select the object to auto track in the image.
When the movement of the selected image is detected, the camera moves in the detected direction.
 - [ / ] is enabled only for models that support Auto Tracking.
-  ▪ DAT is usable only when a SUNAPI camera is registered.

Using the Camera Menu

Click Camera Menu button to toggle display of the connected camera's menu on the screen.

1. Using the PTZ Ball up/down/left/right control button, move to a desired menu.
2. To select the menu, click PTZ ball control.
3. To exit camera menu mode, click [] button.

Preset Control

Click [] button to display saved list of presets.

Select one from the list to set the camera's view to the saved location.

-  ▪ Presets can be saved in Settings menu.
For further information on preset, refer to "**Setting Presets**".
(Page 63)

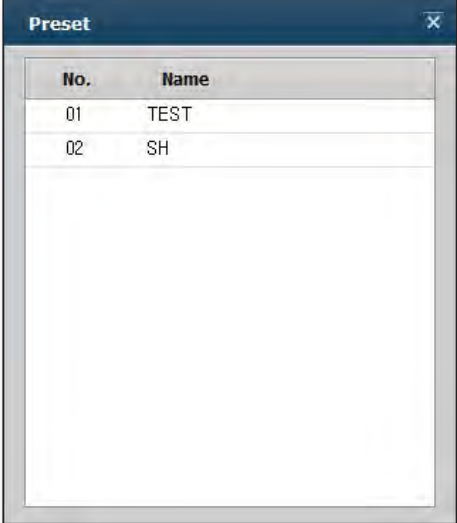

No.	Name
01	TEST
02	SH

Run Tour

Click the [] button to run the tour function.

1. Device Tour : Runs the tour function on the settings page of the equipment.
2. CMS Tour : Runs the tour configured in "**SSM Configuration Manager**."







EVENT LIST

Lists up device events in real-time.

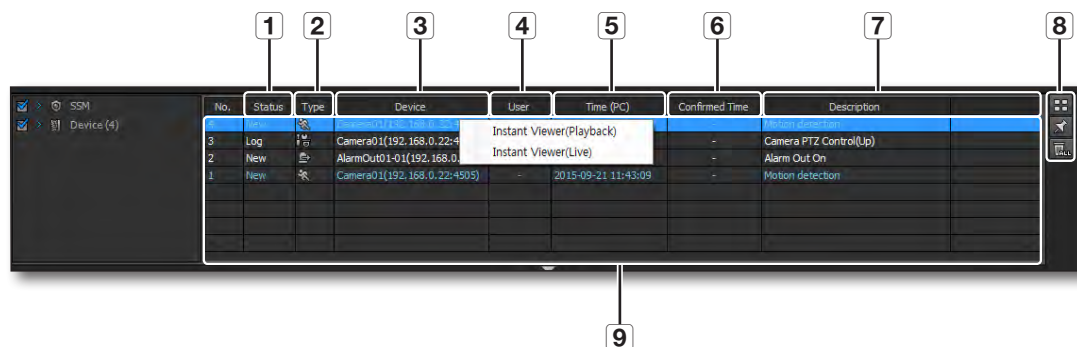
Viewing Real-time Events

You can check device events from all connected devices in the list.
Filter the events by selecting type of events for the Event List.



Item		Description
1	Status	Shows the event status.
2	Type	Shows occurred event's type as icon.
3	Device	Shows the device type.
4	User	In SSM system, it shows the current SSM user's account information. For general device-related events (motion detection, sensor, etc.), the user ID who acknowledged the event is shown.
5	Time (PC)	Shows the event time.
6	Confirmed Time	Shows the time acknowledged.
7	Description	Describes the meaning of the event.
8	View Thumbnail Image	 Displays a thumbnail view at the top of the log list when an event occurs.
	Scroll Lock	 Locks the list not to automatically scroll.
	Clear List	 Fully clears out the event list.
9	Event List	Shows real-time events of the device selected in the left pane. Double click a listed item to open "Instant Viewer" pop-up window. Right mouse clicking on an item opens context menu of "Instant Viewer (Playback)" and "Instant Viewer (Live)".

live viewer

Selecting displayed items

You can select items to be displayed in the event list.

1. Select the title on top of the event list, and right click on it.
2. Select event items to be displayed in the list, by checking the checkbox.
 - Items such as event time (Device), measures taken and alert history can be listed additionally.
 - Event priorities are additionally displayed. Double click the event priority column to sort the events according to the priority.

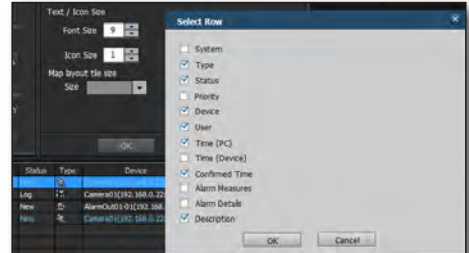

View Thumbnail Image

Displays a thumbnail view at the top of the log list when an event occurs.

1. Click the [] button.
The log list is minimized to the bottom and a thumbnail view appears at the top.
2. If there are too many thumbnail images of events generated to display in a single screen, you can scroll down to view more images.
 - Thumbnail images are displayed in the order of occurrence.
 - Up to 500 thumbnail images can be saved, and the oldest thumbnail will be deleted first.

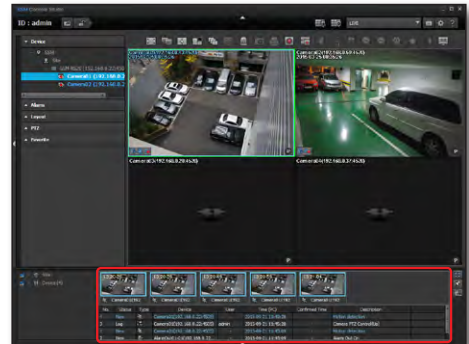

Use the Thumbnail Contextual Menu

1. On the thumbnail screen selected, right-click the image and a selectable contextual menu will be displayed.
2. Select an item to check the event.
 - Instant Viewer(Playback) : A pop-up window to play the recorded event is launched.
 - Instant Viewer(Live) : A pop-up window to show a live image of the camera that is shooting the scene of an event generated is launched.
 - Delete : Deletes the corresponding thumbnail.

 For more information about how to use the instant viewer, please refer to the "**Instant Viewer**" section (page 136).

PLAYING RECORDED EVENTS

Select an event item from the list and right click on it to open context menu of <**Instant Viewer (playback)**> and <**Instant Viewer (Live)**>.

Select either one of them to check the video.

No.	Status	Type	Device	User	Time (PC)
3	Log	🔍	Camera01(192.168.0.224)		
2	New	🔍	AlarmOut01-01(192.168.0.224)		
1	New	🔍	Camera01(192.168.0.224)		2015-09-21 11:43:09

 The <**Instant Viewer (playback)**> is playable only if the corresponding device contains saved data.

Instant Viewer

Select an event displayed in the event list, right-click the selected event and click on the <Instant Viewer (Playback)> in the contextual menu to view the recorded video of the event location, or click on the <Instant Viewer (Live)> to view the live image of the event location.

Names and Functions of Instant Viewer

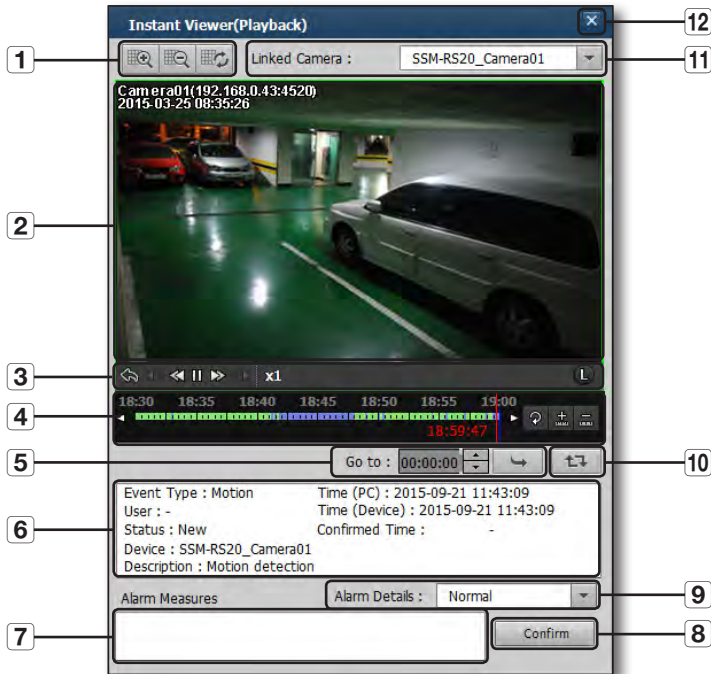

Item	Description	
1	Video Control	Controls digital zooming of the player screen.
2	Display Pane	Shows the video.
3	Video control buttons	Controls the current event playback.
4	Timeline	Moves to a specific time in the current video or expands/shrinks the timeline.
5	Select Time/Play	Plays the video at a designated time.
6	Event Information	Shows the event information.
7	Input field for remarks	Enter the measures taken or remarks regarding the occurred event.
8	Confirm	Confirms and acknowledges the event.

Item	Description
9 Alarm Details	You can selectively record alarm event's type when confirming the event.
10 Repeat Play	Plays the video from the pre-play time (seconds) to the post-play time (seconds) based on the time at which the event occurs. Repeat playing the section from the pre-play time to the post play time. <ul style="list-style-type: none"> You can configure the event pre-play time (seconds) and the event post-play time (seconds) in "Setup > Event > Playback time for event".
11 Connected Camera	For a sensor event, the video of the camera connected to the camera video/sensor specified as the action (output) type in event action can be selected for viewing. For a camera related event, the camera image specified as the action (output) type in the camera video/event action of the generated event can be selected for viewing.
12 Exit	Closes and exits the Instant Player. If [Confirm] button is not clicked, exiting the player does not confirm the event.

- ! Multiple password certification is needed for NVRs that support the multiple passwords function. (Refer to the specifications of the device being used for details.)
- The recorded video can be played in the event viewer, search viewer, Google Map Viewer and instant viewer. It is not possible to play and record a video simultaneously in a single device.

Names and Functions of Video Control Buttons



1	Play the video 30 seconds ahead of the occurrence of the event
2	Step by frames
3	Forward/backward fast play
4	Pause/Play
5	Play Speed
6	P: Playback mode L: Live image mode

- When you select an event and run the instant viewer (playback), the video is played a designated number of seconds (event pre-play time) ahead of the time at which the event was generated; alternatively, when running the instant viewer (playback) on the video window, the video is played a designated number of seconds (pre-play time) ahead of the current time.

live viewer

Names and functions of timeline

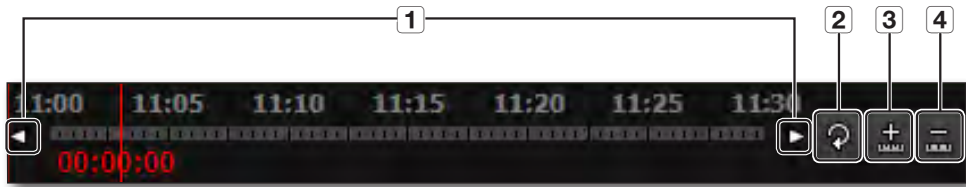

1	Adjust the time intervals of timeline
2	Refresh the timeline
3	Expand the timeline
4	Shrink the timeline

 Only activated in playback mode.

Video Control / Zoom In / Zoom Out Buttons

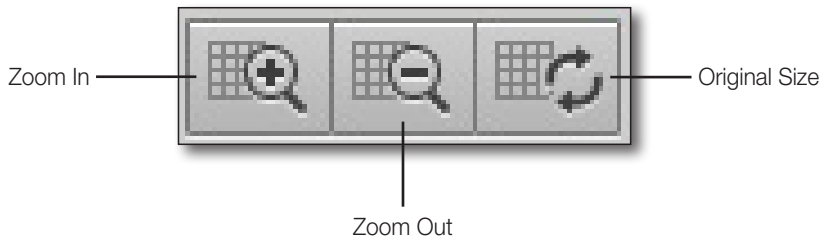

LIVE VIDEO SCREEN

Live feed from the connected device is displayed in the selected tile.

Monitoring by Selecting Cameras

To display video feed from a camera on an unoccupied tile

- Double click a camera from the device tree to display its video feed on the first unoccupied tile.
- Select a tile, and open the context menu to select **<Add Video>**.



- In case of using multiple monitors, it is added to the monitor which is activated.
- When there's no empty tile, the video is displayed on the focused (selected) tile.

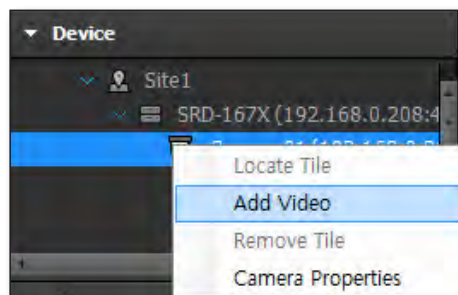

To display video feed from a camera on a specific tile

1. Select a camera from the device tree.
2. Drag it and drop on a desired tile.

To change the video tile

1. Select a tile.
2. Drag it and drop on a desired tile.
Selected two tile's video display swaps each other.

To remove video feed from a tile

1. Select a tile or camera to delete and right click on it.
 - Or, press the **[Delete]** key of the keyboard to promptly delete.
2. From the context menu, select **<Remove Tile>**.
The selected camera's video is removed from the tile and it becomes unoccupied.
3. To remove all video feeds from every tile, click [] button on top of video pane.
Entire tiles become unoccupied.

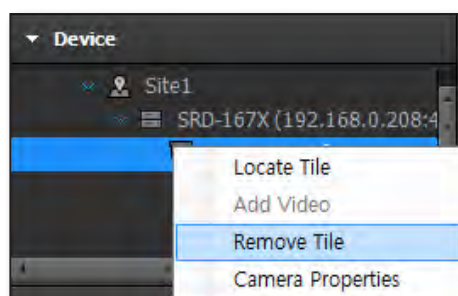

Using Shortcuts

Shortcut keys make SSM even more more user-friendly.

- To open videos using a shortcut key

- 1) Press the <Alt> key. (Keep the 'alt' key pressed before pressing the <Enter> key.)
- 2) Input a number key.
- 3) Press the <Enter> key to open the selected video.



- Check the shortcut key definition in "**Configuration Manager**".

Using the Tile Context Menu

Select a video tile from the video pane and right click on it to open the context menu.

Click to select desired ones from the appeared list of available menu items.

Remove Tile

Removes the video from the selected tile.

OSD

Sets whether to display on-screen display menu and icons on the video screen, such as date, camera name and other information.

It acts the same to that of the [] button on top side of video pane.



- For OSD information selection, check the item in the <OSD Display> selection menu of <Screen>. (Page 191)

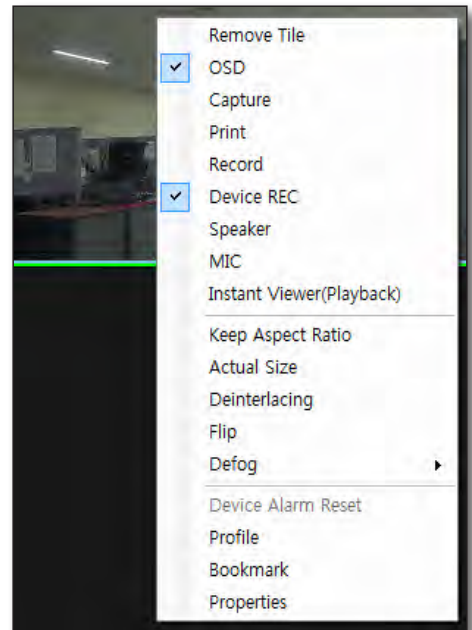

Capture

Saves the video of a selected tile or all registered videos in a designated path. You can select a file type when designating a path.

To save the captured screen

1. Select the <Capture>.

Right-click the window of a video to save and save the video of a selected screen only, or click the  button at the top of the video screen to save the videos of the entire split screens.

- Depending on system configuration, saves immediately without displaying the screen capture setup step.

2. In <Display Information>, check to select information items to be saved with the captured image.

- Camera Name : If checked, saved capture contains the camera name at the top of the image.
- Date/Time : If checked, saved capture contains the time captured at the top of the image.
- Description : If checked, saved capture contains the description recorded in the Description text field.
 - Up to 50 characters can be entered.
- Height x2: Saves the captured image with a height that is twice the height of the original image.
- Path: Selects the path to save the captured image. You can choose the file type when selecting the path. (JPG or BMP file format is available)
 - You can designate the save path in "Environment > Capture" in the Settings menu.

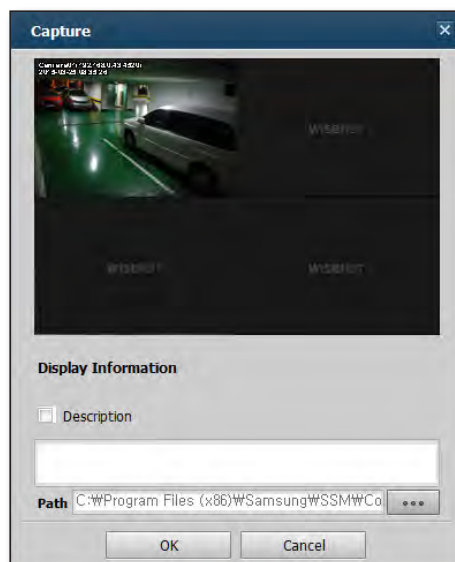
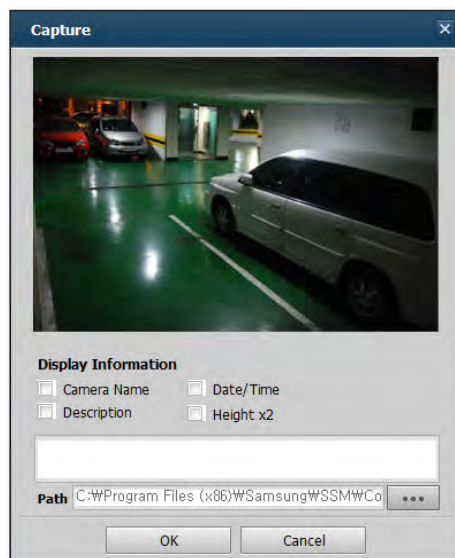

live viewer

- When done with setup, click **[OK]** button.
A popup saying save completed appears.
- To check saved capture file, click **[Open Folder]** button.



- If **<Additional information dialog popup>** option in **"Environment > Capture"** is selected, every capturing prompts with file path and image information on the popup dialog.
- If not selected, capturing directly saves the captured image without prompting with additional information dialog and completion dialogs appears.

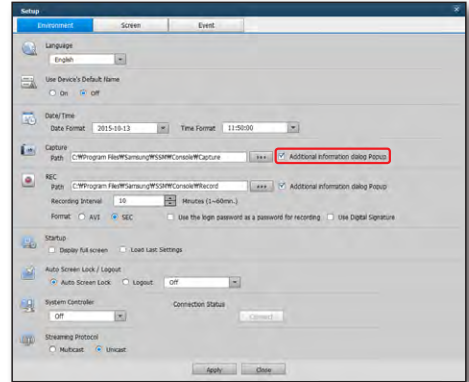
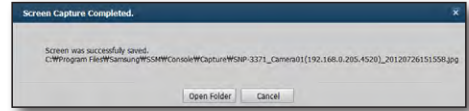

Print

Outputs the image of a selected tile or all registered images to a printer connected to the PC.

To print the screen

- Select the **<Screen Print Information>**.
Right-click the window of a video to print and print the image of only a selected screen, or click the  button at the top of the video screen to print the image of the entire split screens.
- In **<Display Information>**, check to select information items to be printed with the screen image.
- Click **[OK]**.
Print window of the printer connected to your computer appears.



- For further details on **<Display Information>**, refer to **"Capture"**. (Page 141)

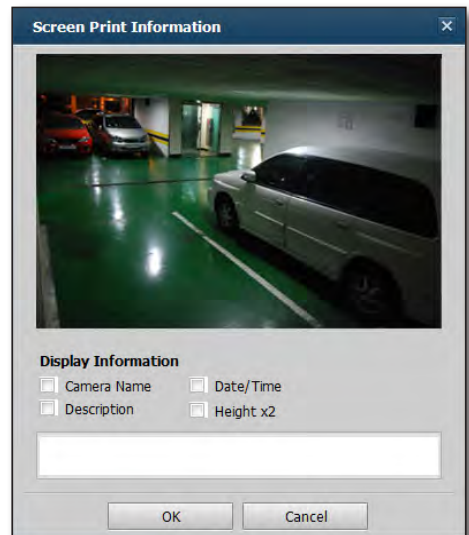

Record

Starts and stops recording of the currently selected tile.
It acts the same as the [] button on top side of video pane.

To start recording

1. Click <Record>.
 - The "Record" window appears.
 - Depending on system configuration, records immediately without displaying the record setup step.
2. Set the file path and click [OK] button.
 - The record indicator appears on the tile and starts recording.
3. To stop recording, click <Record> again.
 - A "Warning" dialog appears.
4. Click [OK].
 - Unchecking the checkbox in front of <Record> stops the recording.



- If <Additional information dialog popup> option in "Environment > REC" is selected, every recording prompts with file path on the popup dialog.

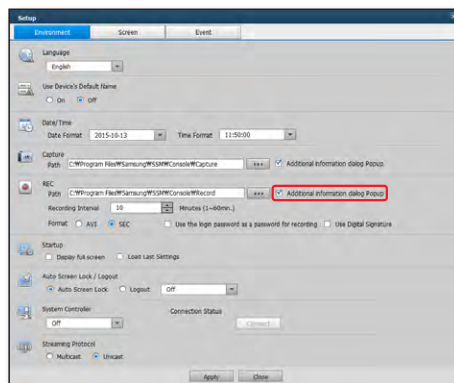
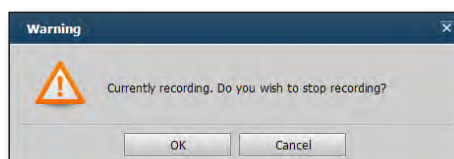
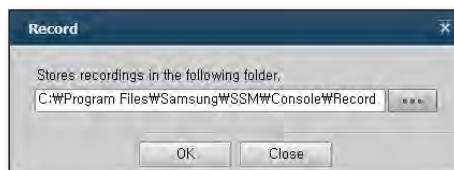

live viewer

Device REC

Starts or stops recording onto the device connected to the tile's camera. It acts the same as the [] button on top side of video pane.

Speaker

Transmits or stops Transmitting sound from the selected camera. It acts the same to that of the [] button on top side of video pane.

Microphone

Produces sound through the microphone at a remote device. It acts the same to that of the [] button on top side of video pane.

Instant viewer (Playback)

An instant viewer (playback) pop-up window for the selected channel is launched.



- Only playable if the device contains recorded footage data.
- For further use of the Instant Player, refer to "Instant viewer". (Page 136)

Keep Aspect Ratio

Keeps original video's aspect ratio. If not selected, the video is filled into the video pane.

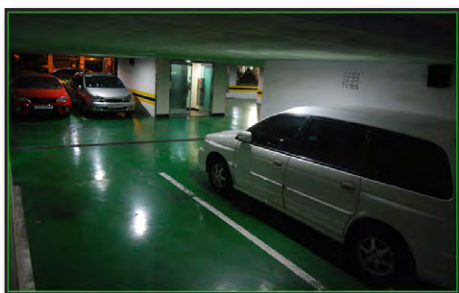

< Variable Aspect Ratio >

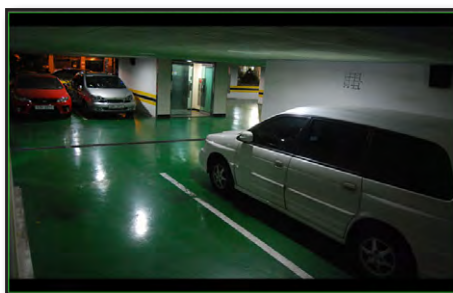

< Keep Aspect Ratio >

Actual Size

If selected, the video is reset to the original size. If the video's size is bigger than the screen, you can move it with mouse dragging.

Deinterlacing

Sets or cancels deinterlacing of the tile's video.

Flip

Flips the video vertically.

Fog Removal

The fog removal menu is displayed for cameras supporting the fog removal function.

- You can select Off / Auto / 1~10.

Device Alarm Reset

Initialize the alarm settings.

Profile

In the camera settings page, a list of profiles configured is displayed in order. You can select a profile to output. The profile currently in the process of output is displayed as inactive.

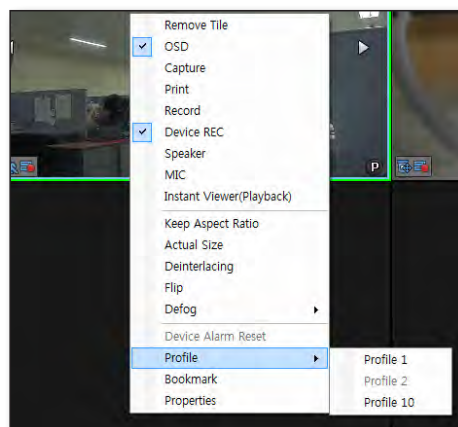

Properties

Shows the selected camera's property information in a pop-up window.

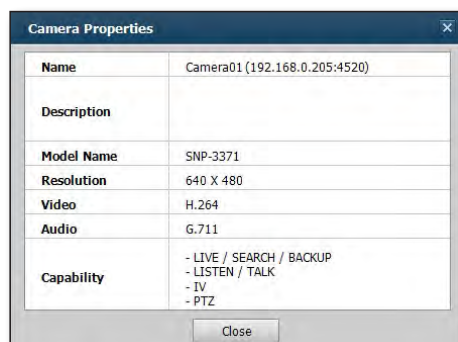

DIGITAL ZOOM

Digital zooming allows the enlarging of the video as if using a magnifier. It works on the displayed image by enlarging it digitally, which is different than optical zooming of lens. Digital zooming provides magnification up to 16 times of the original.

Setting Digital Zoom Area

1. From the top side menu, click [] button.
It switches to digital zooming mode, and every clicking magnifies the image by 50%.
2. Click a desired video and then drag it or click Zoom In button for further zooming.
Enlarged image is centered by the point you clicked.
When an area is selected by dragging, the selection fills the screen.



Digital Zooming Out

1. From the top side menu, click [] button.
2. Click a video.
Reduced image is centered by the point you clicked.
Every clicking of Zoom Out button reduces the image by 50%.



Exiting Digital Zoom

1. From the top side menu, click [] button.
2. Digital zooming ends, and the video is reset to the original.

Moving Video Area with Pan Cursor

1. While in digital zooming, click on the zoomed area marker shown near the bottom of digital zoom screen.
2. While holding mouse button, drag to move it to a desired area.



< In Digital Zooming >

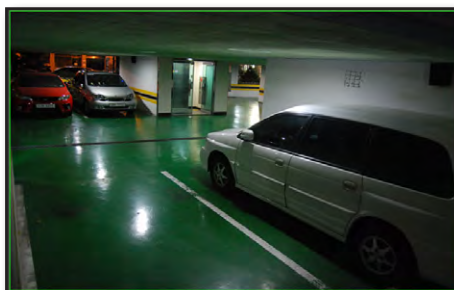

< Released Digital Zooming >

- 
 - If clicked Zoom In/Out button, it resizes by 50%.
 - Restoring to the Original Size exits digital zooming.



Switching to Full Screen Mode

1. From the top side menu, click [] button.
Only the video pane fills the screen.
2. To exit the full screen mode, press [Esc] on the keyboard.

Running Sequence

This function enables an automatic sequence display of channels in a pre set time.

Used when there are more connected channels than the current screen splits. It switches to the next set of channels according to the current screen split mode.

1. From the top side menu, click [] button.
Runs sequenced display in the current split screen mode.
2. To exit sequence mode, click [] button again.

- 
 - While in sequence mode, Map Layout becomes unavailable.
 - The Sequence mode supports split screen mode up to 16-splits. If you configure Sequence mode to include a layout having more than 16 splits, actual Sequence mode operation limits playback to 16-split mode.
 - You can define the order of layouts and their dwell time for sequence mode in "Setup > Screen > Monitor". (Page 190)

Fish-Eye View Mode

For Fish-Eye cameras, the Fish-Eye View mode context menu is available.

- Over View : Original image
- Panorama : The panorama image split to top and bottom can be moved independently.
- 4-way split screen : Each part of the 4-way split screen can be moved independently.
- Single View : Default view. The image is displayed in a single view.
- 1 Over View + 3Rectangles : The screen is organized into an over view and 3 way split images. Each part can be moved separately.

Use of Panomorph Lens

The function supports a viewing angle of 360° using the mouse in the video tile of the camera on which the Panomorph lens is enabled.

1. Pan/Tilt Operation: Click on a tile and drag it to move the camera along the mouse drag.
2. Zoom Operation: Right-click and drag the mouse up or down to zoom in or out.
3. The PTZ panel can be used like a conventional PTZ camera.
4. It supports the Area Zoom and Preset functions like a conventional PTZ camera.
5. It supports the zoom function using the mouse wheel like a conventional PTZ camera.
 - Perimeter : This is a panorama image split into top and bottom.
 - 4-way split screen : Each part of the 4-way split screen can be moved independently.
 - Single View : Default view. The image is displayed in a single view.



- When printing the Panomorph or Fish Eye image, the position set as the home position in CM is printed in single view by default.

Using Shortcuts

Shortcut keys make SSM even more more user-friendly.

- To open videos using a shortcut key
- 1) Press the <Alt> key. (Keep the 'alt' key pressed before pressing the <Enter> key.)
 - 2) Input a number key.
 - 3) Press the <Enter> key to open the selected video.



- Check the shortcut key definition in "**Configuration Manager**".

- Controlling PTZ Camera with Keyboard

Select a PTZ camera and press an arrow key to move the PTZ camera in the selected direction.

POS

You can check the list of receipts of the connected POS device.

When you click the [] button at the top of the video window, the list of POS and receipts is displayed on the right side of the live screen.

- Function that is supported by NVR.

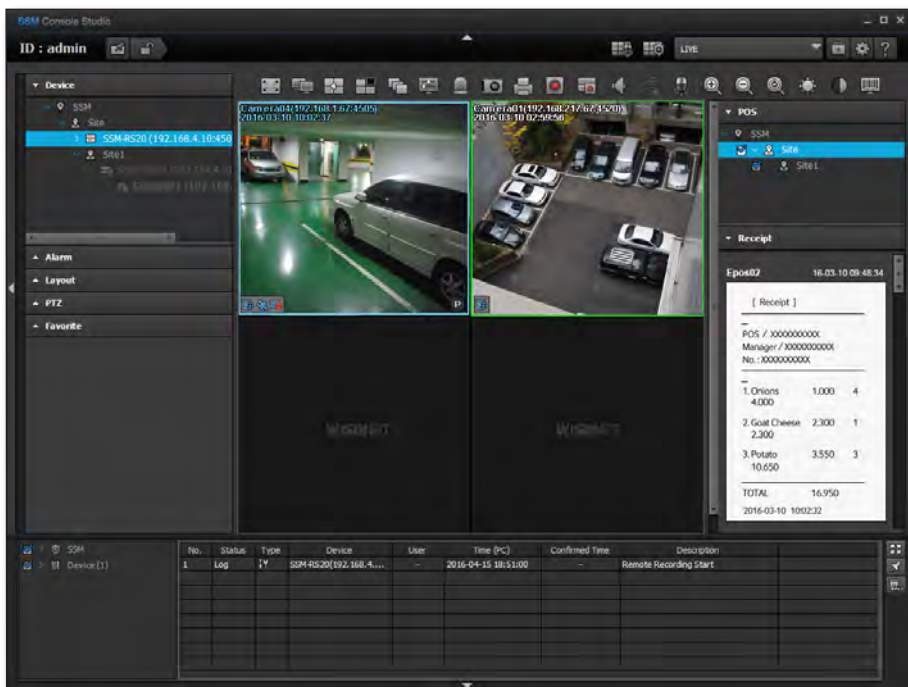

View list of POS devices

1. Click the [] button at the top of the video window.
2. The list of POS devices connected is displayed.

View List of Receipts

1. Select a POS you want to print out on the list of POSs connected.
2. The receipts of the POS selected are displayed in consecutive order.



- Up to 50 receipts are displayed in the order of payment time.
- Select a specific POS in the POS device list and double-click or drag to the live screen, and the live video of the camera connected to the POS is displayed.
- When POS payment is completed, the applicable information is output on the event log screen.
- The name of the POS is displayed on the screen of a camera connected to the POS.

View POS Instant Viewer (playback)

When you double-click the receipt/receipt event on the right side of the live screen, an "Instant viewer (playback)" window will launch.



- For more information about the instant viewer, please refer to "Instant Viewer". (Page 136)

Shows the list of devices connected to the POS device.

The screenshot shows the "Instant Viewer(Playback)" window. The main area displays a video feed of a silver car in a parking garage. The video player includes a timeline from 18:30 to 19:00, with a current time of 18:59:47. The video is playing at x1 speed. On the right side, there is a receipt for "Epos01" dated 16-04-27 09:26:09. The receipt lists items: 1. Onions (4.000, 1.000, 4), 2. Goat Cheese (2.300, 2.300, 1), and 3. Potato (10.650, 3.550, 3). The total is 16.950. Below the receipt, there is a list of event details: Event Type: EPOS, User: -, Status: -, Device: SRN-4000_Epos01(192.168.10.166:4520), Description: (Camera02, Camera03), Time (PC): 2016-04-27 09:26:21, Time (Device): 2016-04-27 09:26:21, Confirmed Time: -. At the bottom, there is an "Alarm Measures" section with "Alarm Details" set to "Normal" and a "Confirm" button.

Shows the POS information and the receipt information.

event viewer

It provides viewing of real-time events and searching / playing events of devices.
 Select [EVENT] menu of the viewer selection tab on the top right side of SSM Console.
 Or, select [EVENT] viewer on login screen of SSM Console.

NAMES AND FUNCTIONS OF EVENT VIEWER

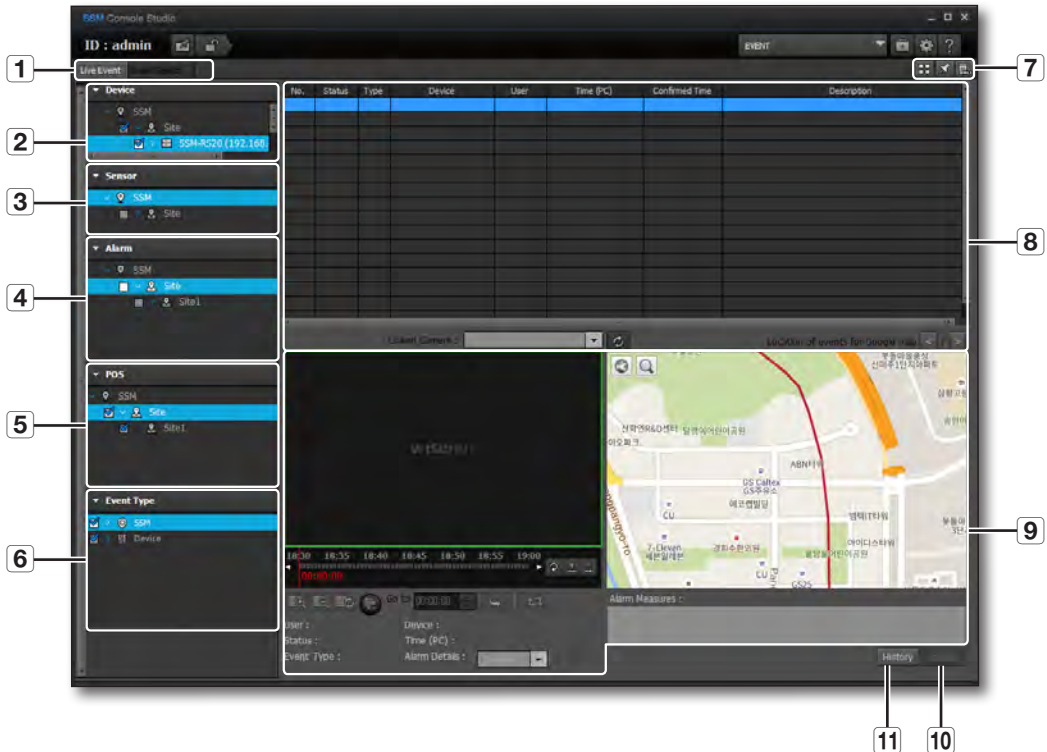

Item	Description	
1	Live Event / Event Search Tabs	Select either one of real-time event and event search.
2	Device List	Select a device to display events of the selected device in the event list.
3	Sensor list	Select a sensor to be displayed in the event list window.
4	Alarm list	Select an alarm to be displayed in the event list window.
5	POS list	When you select a POS, only the information of the POS selected is displayed on the event list window.
6	Event Type	Shows selected type of events only in the event list.
7	View Thumbnail Image, Scroll Lock, Clear List	A thumbnail view of a camera-related event is launched. Locks the list not to scroll, and clears all events listed.

event viewer

Item	Description	
8 Event List	Shows events, click column header to sort events by the selected one.	
9	Event Details	It displays the detailed information and video of the selected event. <ul style="list-style-type: none"> It displays the information of all events.
	Event Location	Displays the location of an event generated through inter-operation with Google Maps.
10 Confirm	When clicked after confirming the event searched, acknowledges the event. All events other than log, SSM (User, System) and Device (System, Alarm Out) can be confirmed as cleared event.	
11 History	Shows the event history of the selected.	

-  The event viewer maintains the tree selection setting and applies it to the tree.

EVENT SEARCH

Viewing Live Events

You can check real-time events in the event list.

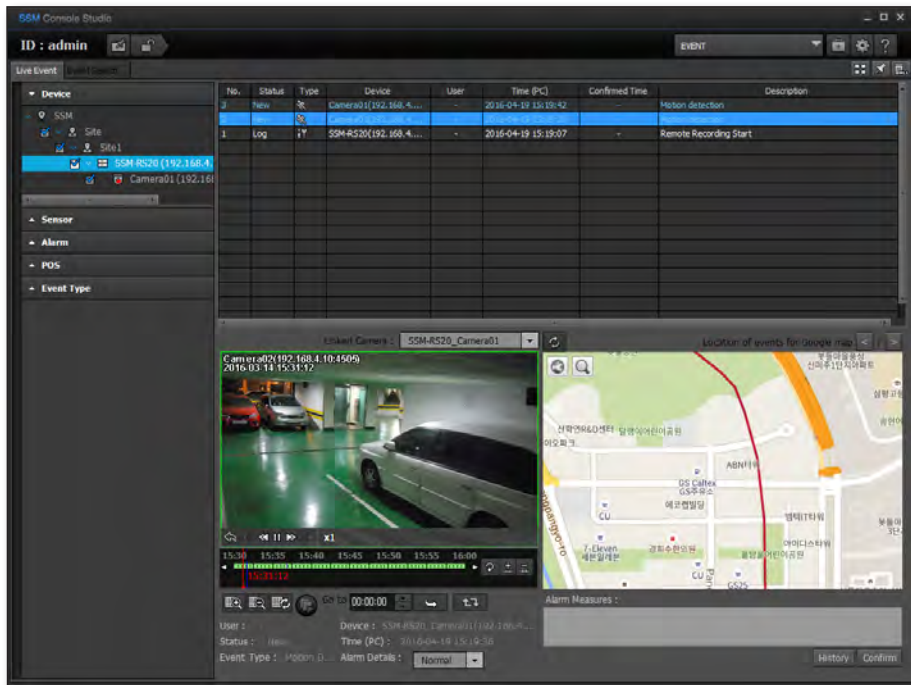

-  For further details on checking events, refer to "Searching Events". (Page 153)

Searching Events

Click Event Search tab to display event search menu.
You can specify event type and time for search.

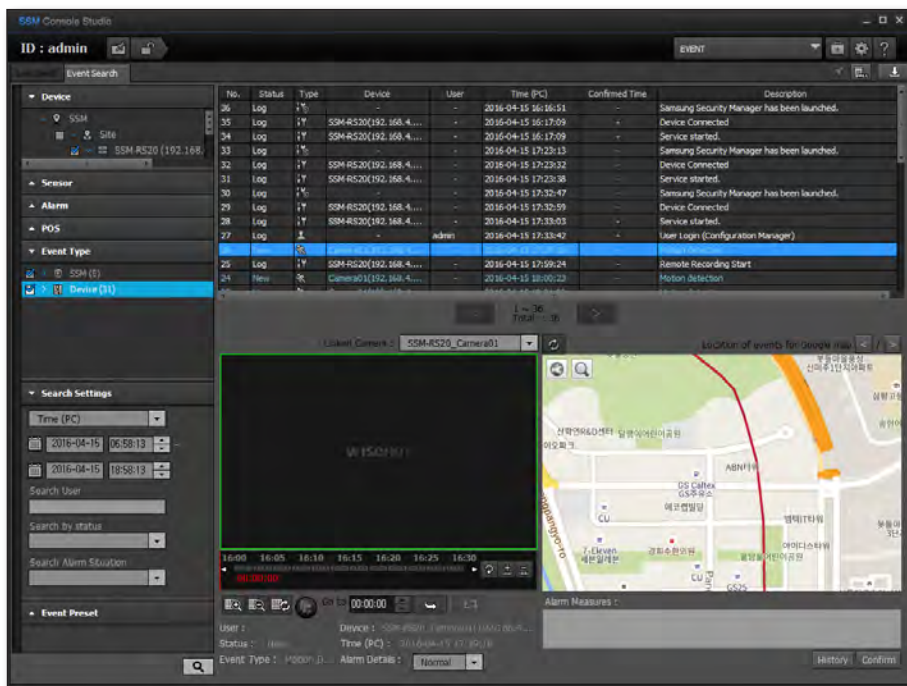

- Select desired event types by checking the checkboxes.
 - SSM : User, System
 - Device : System, Camera, Sensor, Alarm Out, POS
 - Camera : System, Movement detection, Video loss, Intelligent image analysis, Pass, Entry, Exit, Appearing/Disappearing, Tempering, Tracking, Face recognition, Audio detection
 - Refer to "HA Event" for details of "HA". (Page 76)

event viewer

2. Filter by time to search logs.
 - Time (PC) : You can search for occurred time.
 - Time (Device) : You can run event search based on the device time.
 - Confirmed Time : You can run event search based on the confirmed time.
3. Use calendar to specify search date.
4. Specify the start time and end time.
5. Click the [] button.
Events match the search criteria are listed.

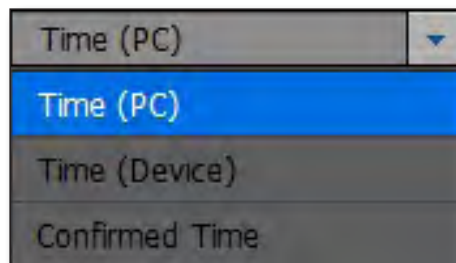

- Recorded video footage can be played with Event Viewer, Search Viewer and Instant Player. Note that one saved footage cannot be played with multiple viewers at the same time.
- Maximum of 10,000 event search results are displayed.

Event Preset

Save the event search condition and select a saved search condition to search the events.

1. Right click the mouse in the <Event Preset> section and select <Save Preset>.
2. Input the name of the preset of search condition and time of search then click the <Save> button.
3. You can change or delete the saved event presets.

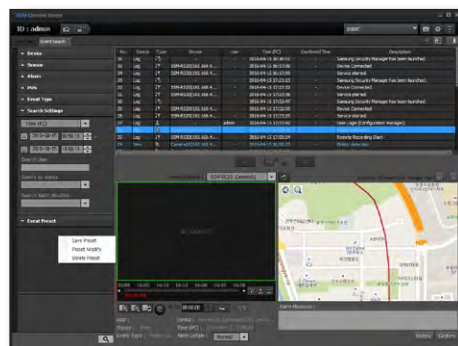

Consecutive playing of events

Select events in the list to be played consecutively.

1. Select events for consecutive playing from the list of searched events.
2. Select an event and right click on it to select **<Sequential Playback>**.
 - You can click the [] button on the event playback control to play the video in order.
3. The selected events will be consecutively displayed on the window.



- For more information about how to use the event playback control, refer to the "Instant Viewer" section (page 136).

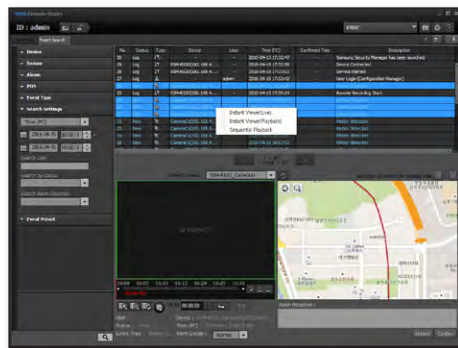

Inter-operation with Google Maps

- When an event is selected

If the camera of an event selected is registered in Google Maps, the corresponding map is automatically displayed.





- When playing events in sequence

1. Event videos are played sequentially.
2. Whenever the video is played, the position of the corresponding camera is displayed on the map of the event location.
3. Move to Play in Sequence button is activated simultaneously when the Play in Sequence button is pressed, enabling you to move to the event location (the map also moves accordingly).

event viewer

Backing up event logs

You can backup all the events searched in the list.

1. Press the [] button.
2. When the <Backup Event Log> window appears, press the [] button to set the backup path and then press the [] button.
3. When the backup is finished, press the [] button to check the full event details and a stat report.
4. As needed, use shortcut buttons on the top side of the report to print, or save the report as an Excel, PDF or Word file.

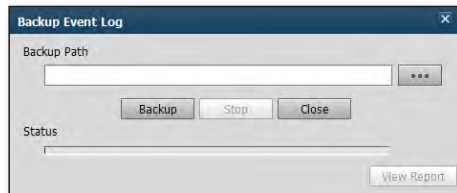

Confirming Events

You can check details of event searched in the list, and confirm it to end the event situation.

1. Double click an event to see its details from the list.
 - In the event details pane, the event video is played as well as its details.
 - Or, select an event and right click on it to open <Instant Viewer>.
 - For further information on playback control, refer to "Instant viewer". (Page 136)
2. Check event details and set <Alarm Details> to either one of <Normal>, <Abnormal> and <Etc>.
3. Describe the measures taken.
4. Click [Confirm] button.
 - Once confirmed, it is marked in the list.

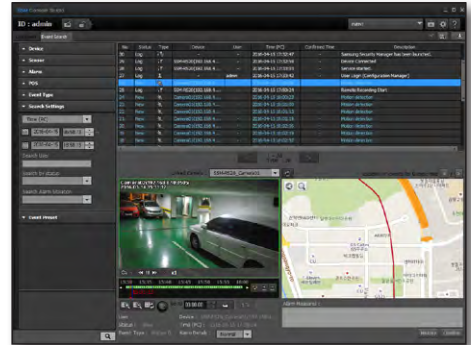

History

For confirmed events, you can see the confirmed details of the selected event from the list.

1. Select an event to see its history from the list.
2. Click [History] button.
3. Check event confirmation details.

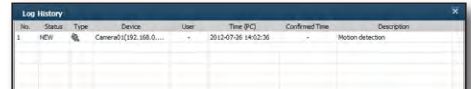

- If user A described intrusion path in the Alarm Measures for an event, and user B added notes on further details of taken measure and confirmed that event, such process of alarm measure can be checked afterwards with History function.

search viewer

You can search and play footages stored in your local computer or in the device. Select **[SEARCH]** from the Viewer selection menu in the upper-right section of the SSM Console main window.

It is possible to start by selecting **[SEARCH]** Viewer from a login window of the SSM Console startup stage.

NAMES AND FUNCTIONS OF SEARCH VIEWER

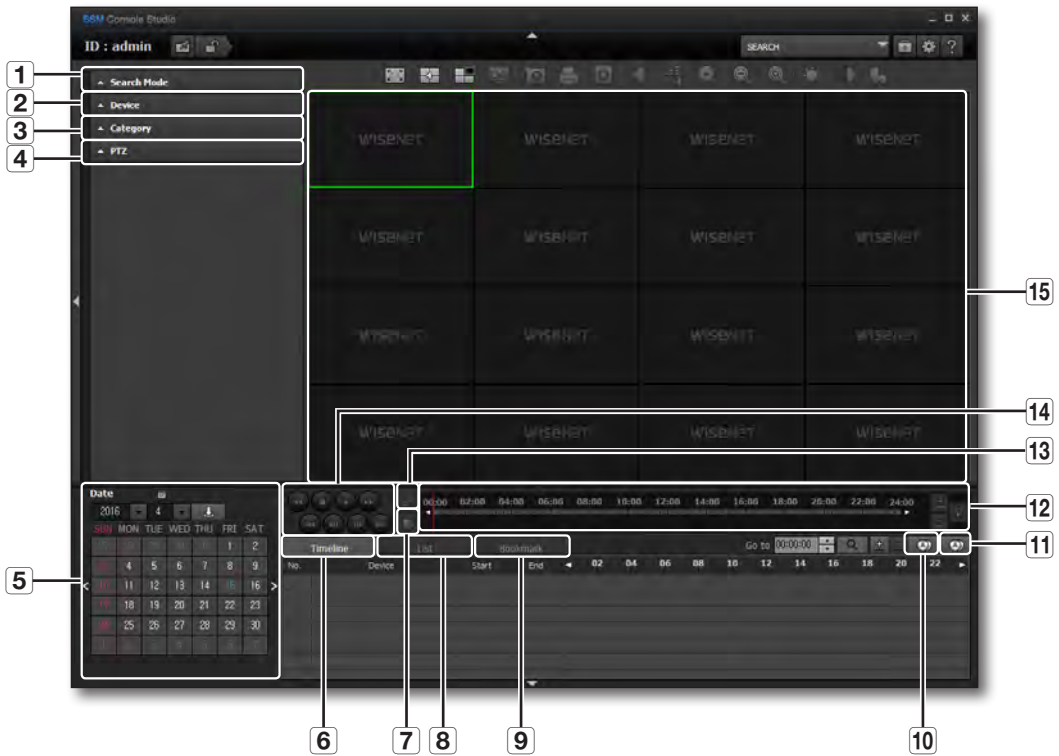

Item	Description
1 Search mode	You can select Basic, Advanced, Masking, Folder or POS as the search mode.
2 Device List	Shows devices that can be searched over.
3 Category	Shows available event types for search.
4 PTZ	The PTZ panel is enabled to use PTZ when replaying the recorded file on a camera set up to use the Panomorph lens. The PTZ, AreaZoom, and preset functions can be used. <ul style="list-style-type: none"> Refer to "Use of Panomorph Lens" for more details. (Page 148)
5 Date/Time	Dates with found matches from the selected device is marked on the calendar.

	Item	Description
6	Timeline	Sets the search result list to timeline format.
7	Add a Bookmark	Adds a bookmark for the currently played screen.
8	List	Sets the search result to a list of events sorted by events.
9	Bookmarks	Shows the bookmarks added to the bookmark list.
10	Backup	Sets the time period for backing up searched data.
11	View Onetime Schedule Backup Status	You can check the onetime schedule backup settings configured in the backup window.
12	Detailed Timeline	Use this timeline slider to move selected search result's specific moment, or zoom in/out the timeline.
13	Simultaneous Play	Plays multiple channels at the same time.
14	Playback Control	Playback controls for playing back search result.
15	Display Pane	Shows the video of searched result.



- The context menu displayed when you right-click on the device list and video window has the same contents as the live viewer.
- On the context menu of the video window, you can directly move to <Advanced Search> and <Masking Backup>. <Advanced Search> is used to search the currently selected device with more detailed search options than are available in the <Basic Search> function.

search viewer

Device List

From the device list, you can select desired device for your search.

1. Search desired device from registered devices.
2. Click a website to search or the check box of the device to select.

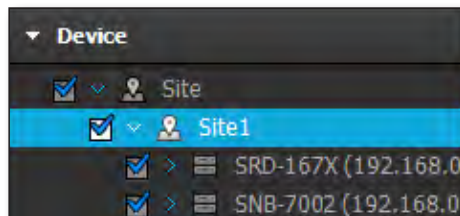

3. Multiple password certification is needed for NVRs that support a multiple passwords function.



- When a device that is set for multiple passwords is selected, a popup window is displayed.
- Multiple password setup can be performed from the device web viewer.
- Refer to the specifications of the device to use for details.

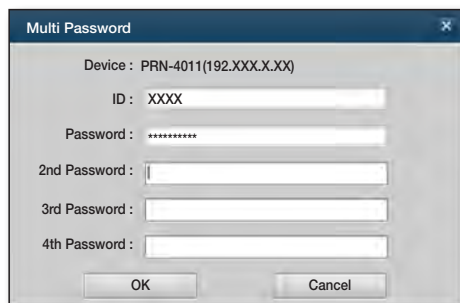

Date Search

If selected device contains recorded data on a date, it is marked on the calendar.

1. Select a device and click [] button.
2. Select year and month for your search.
If a date has recorded data, it is marked in color.
3. Click to select a date to be searched.
Detailed time period of recorded data is shown in the search result area.

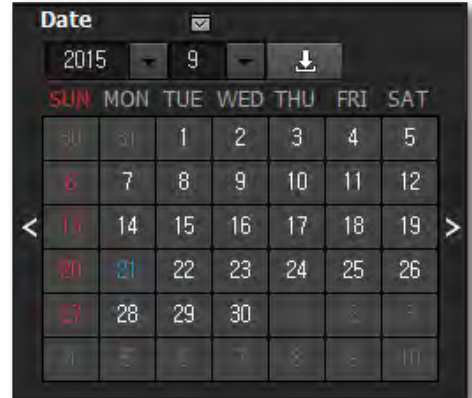

Category

You can set the search criteria with event types.

1. Click Category.
Category items appear.
2. Select desired search category items.
 - Video Loss, Motion Detection, Video Analysis, Audio Detection, Sensor, Auto Recovery Backup, User Defined Event, Continuous, Manual : Search is performed based on the screen highlighted on the video screen.
3. Search results matching selected items are shown in timeline.
 - Displayed in the timeline in a color designated for each item.

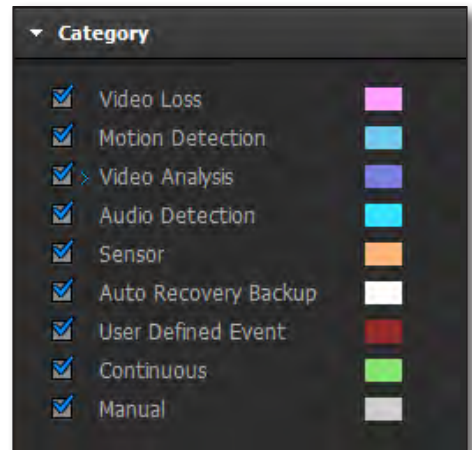

search viewer

Digital Zoom

Digital zooming provides enlarging the video as using a magnifier.

1. Click a desired camera's video.
2. Use digital zoom button to magnify/reduce desired portion of the video.
3. Brightness and contrast can be adjusted too.
 - Click [] button to reset to the original.

- For further details on using digital zoom, refer to "**Digital Zoom**". (Page 146)



Playing Searched Data

Setting the playback point of time

In the timeline of search result, the red vertical line means the current playback point of time.

1. Set the time to play.
2. Click [] button on the right.
The point of time for your playback is set to the chosen time.



- Or, drag the red strip or click on a desired point in the timeline to set playback point of time.
- The time display shows the current playback's record time.

Selecting Camera for Playback

By default, the search result shows 5 channels in the list. You can resize it to show more or scroll down it. Video playback supports up to 16 simultaneous channels.

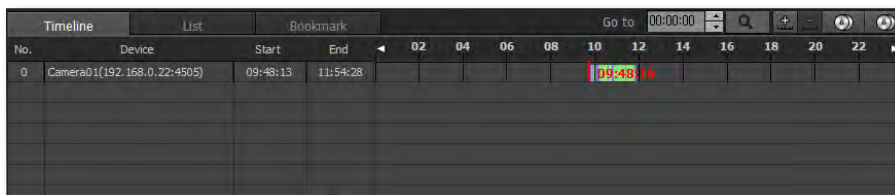

1. Double click desired camera in the search result.
2. Selected camera's video fills the first unoccupied video tile.



- Or, drag a camera from the search result to a tile and drop in the video display pane to add the selected channel's video to the tile.

Select Multiple Timelines

Select multiple devices in the timeline, and drag and drop them on the video window at the top to play the video that has been searched.

- When the screen is split into 16 sub screens, you can choose up to 16 channels.

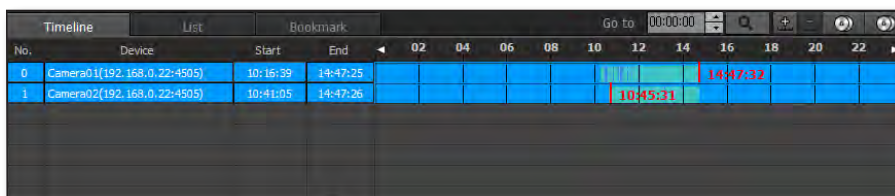

search viewer

Enlarging the Timeline Scale

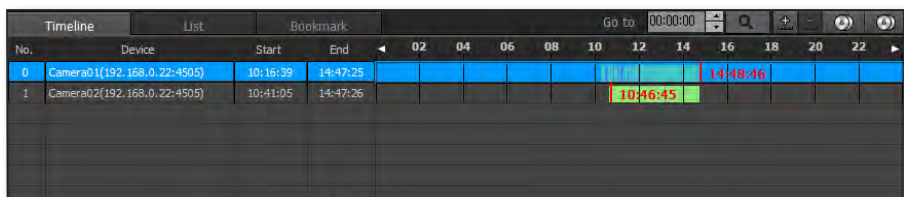

< 24 Hours >

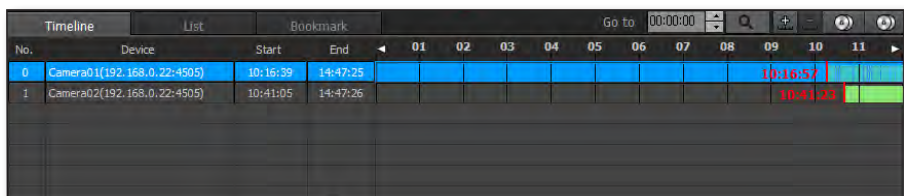

< 1 Hour >

1. Click [] button in the top right corner of the search result area.
2. It enlarges the timeline scale of searched data from 24 hours to 5 minutes, the button becomes disabled when the maximum limit is reached.

Reducing the Timeline Scale

1. Click [] button in the top right corner of the search result area.
2. It reduces the timeline scale of searched data from 5 minutes up to 24 hours, the button becomes disabled when the minimum limit is reached.

Moving the playback point

When a search result is found, the playback point is set to the time currently selected.

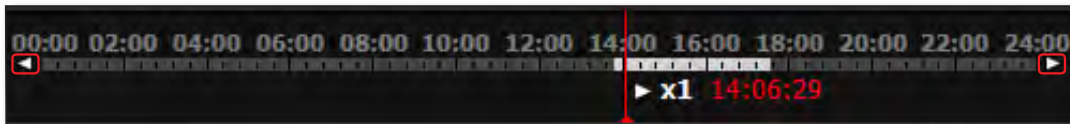

1. Select a search result.
The playback point is set to the time currently selected, marked with a red vertical line.
2. Drag the red vertical line to a desired point of time in the timeline.
When in enlarged timeline, you can use < ◀, ▶ > arrows on both ends of the timeline to move backward/forward.

Playback Control

Pause or control playback speed.

Playback

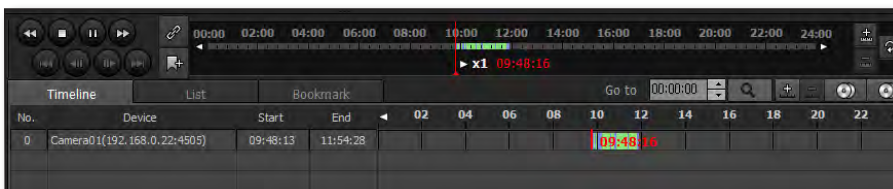

1. Select a search result and click [▶] button.
In the playback progress bar, the current playback speed is indicated.
2. Use playback control buttons to control playback faster or slower.

search viewer

Control Bookmarks

You can set a specific start point of a searched data video with a bookmark.

- This function is only available on a recording server.

Add a Bookmark

1. Select a video and time to bookmark and click the [] button.
The Add a Bookmark pop-up window is launched.
2. Set the bookmark name.
3. Click <OK> to add the bookmark to the bookmark list.

- Up to 512 bookmarks can be added. If you exceed 512 bookmarks, the oldest one will be deleted first.

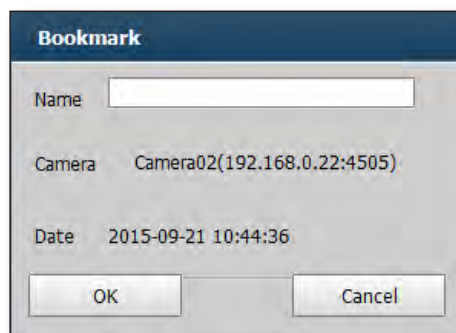

View the Bookmark List

The timeline and the bookmarks added to the bookmark list will be displayed.

1. Bookmarks set in the bookmark list will be displayed.
 - Bookmark is indicated with a red triangle at the bottom of the timeline.
2. You can move to the corresponding video by double-clicking the value on the bookmark list.
3. Right-click on the bookmark list to change the name of a bookmark or delete a bookmark.

- The closest bookmark while playing the video will be marked in red 30 seconds ahead in the list.

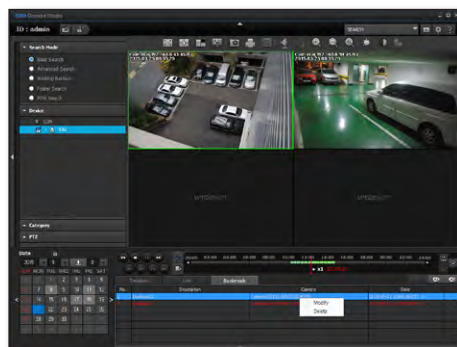

Names and Functions of Playback Controls

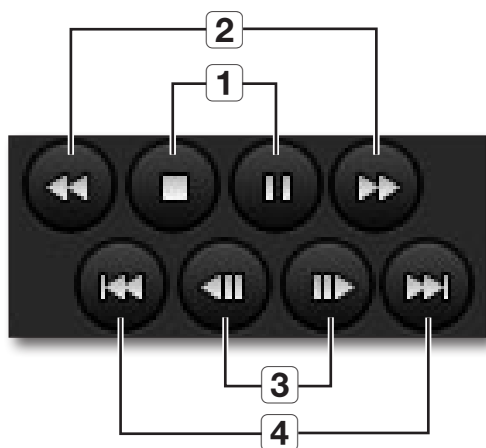

1	Start / stop playback, Pause
2	Faster forward / backward playback Sets the forward/backward playback speed to x1, x2, x4, x8, x16, x32, x64, and then x1 again on every click. <ul style="list-style-type: none"> When in paused, it switches to slower forward / backward playback button.
3	Step Forward / Backward Moves the video frame by frame. While in playback, these buttons are disabled.
4	Skip Forward / Backward Skips to previous or next event. While in playback, these buttons are disabled.

Selecting the Search Mode

Click a radio button to switch to the Basic, Advanced, Masking, Folder or POS search screen.

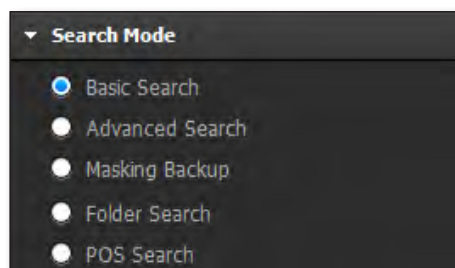

search viewer

ADVANCED SEARCH

If there are recorded data, they can be searched according to the search condition.

Smart Search

A specific section of the image is selected as ROI, Exclusive Zone, or Virtual Line to search the events that have occurred during a specific time band.

1. Switch to the <Smart Search> model of <Advanced Search> and select the device to search in the <Device> list.
 - SUNAPI camera should be registered as a function that is supported at SUNAPI NVR or Recording Server.
2. Select the year and month to search and click the [] button.
Dates containing data are displayed. When a date is selected, the data are displayed in the time-line list.
3. Select the data from those displayed in the time-line list.
4. Adjust the time-line bar to set the preview image.

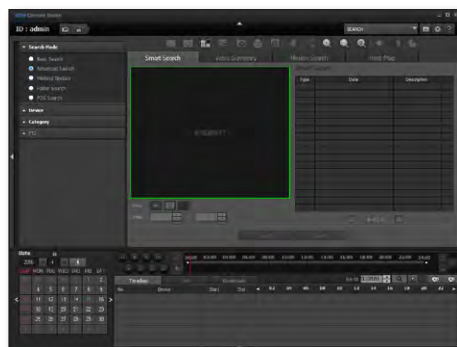

- Time : Select the beginning and end time for the search.
 - The difference between the beginning and end time can be up to 24 hours.
- Setting the Search Region
 - ROI (Region of Interest) : Designate ROI on the image window to detect the events within the region. Specify a point on the image window with the mouse and draw a line to specify the region. Up to 11 vertices are allowed within an interior angle of 180 degrees. (Up to 32 ROI's can be specified.)
 - Click the right mouse button to complete specification of ROI. (ex.: To draw a rectangle, specify 4 points and then right click the mouse)
 - After a region is set, the event setting window is displayed. Select the event type to detect of three events (multiple selections allowed) and click the <OK> button. The region setting is canceled when <Cancel> is clicked.

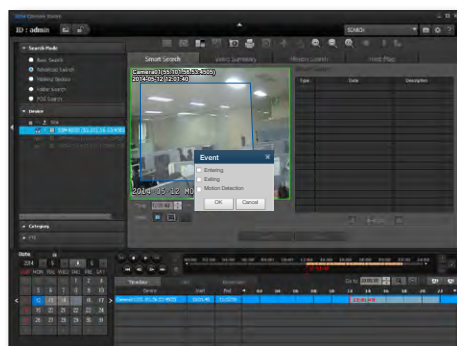
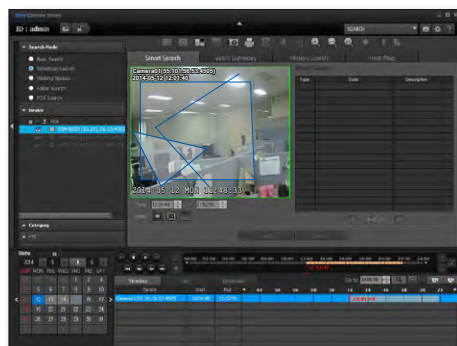

- Exclusive Zone (Region of Non-interest) : Specify the exclusive zone on the image window to exclude the events within the region in the search result. Specify a point on the image window with the mouse and draw a line to specify the region. Up to 11 vertices are allowed within an interior angle of 180 degrees. (Up to 32 ROI's can be specified.)
 - Right click the mouse to complete specification of ROI.
(ex.: To draw a rectangle, specify 4 points and then click the right mouse button.)
 - Virtual Line : Draw a virtual line on the image window. Motion is searched when a movement from the line to the set direction is detected.
 - Select Left or Right. They can be selected simultaneously to detect motion in both directions.
-  ▪ For the ROI, exclusive zone and virtual line, place the mouse on the drawn region and right click the mouse to change or delete the region.
5. Click the **[Search]** button.
 6. Check the result of smart search and double click the search result to replay the selected image.
 - Up to 500 smart search lists can be checked. Click the **[◀/▶]** button to navigate between pages.
 7. Click the **<Export>** button to save the search results in an excel file.

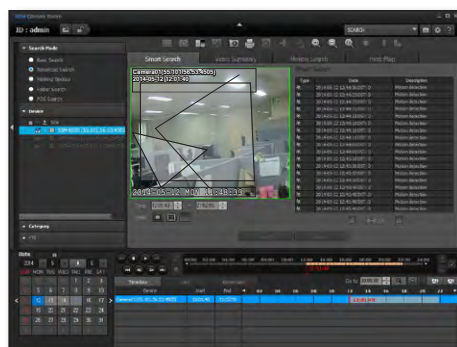

Using Smart Search

1. SUNAPI camera should be registered to SUNAPI NVR or Recording Server. (Refer to SUNAPI supporting camera specification.)
2. Set the motion event of the camera to **<On>**.
 - The camera event can be set in the camera Web page.
 - Motion event On, no region setting (detection of motion in all regions.)
 - Accessing the camera Web page : Select a camera in the Registration > Device menu of the Configuration Manager and click the **[Device Setting Page]** button of the device information.

search viewer

Video Summary

You can search a specific time of a video and an event occurring in the area of the video, and create a summary video to play.

- SUNAPI camera should be registered as a function that is supported only at Recording Server.

1. Switch to **<Video Summary>** mode of **<Advanced Search>**, then select a device to search in the **<Device>** list.

2. Select a month and year to search and click the [] button.

The date on which the data is searched is displayed.
When you select the search results, the corresponding data is displayed on the timeline list.

3. Select the desired data from the data displayed in the timeline list.

4. Adjust the timeline bar to adjust the preview video.

- Time : Select the start time and end time to summarize.
- Density : You can adjust the number of events to show at once.
 - The higher the density, the shorter the duration of the summarized video.
- Configure the Play Window : Configure the area to be summarized in the video.
 - For more information about how to configure the area, refer to the "Smart Search" section (page 168).
- Path : Selects a path to save the summarized file.

5. Click the [Video Summary] button.

- While saving the video summary file, the preview image is provided on the right side of the screen.
- Clicking the Time Stamp check box displays the time at which a motion is generated in the upper part of the object generating the motion.

6. Click the **<Export>** button to save the search information in an SEC file.

- Click the Delete button on the History list to delete the information saved.

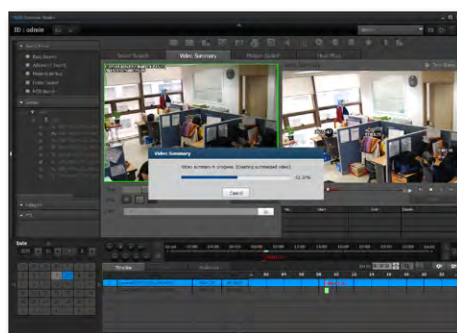
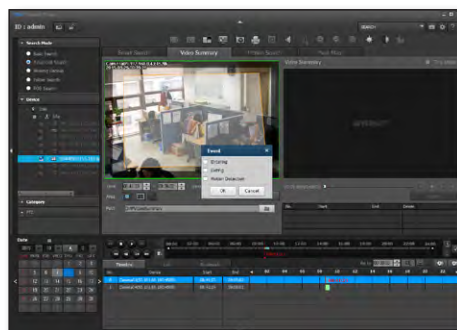
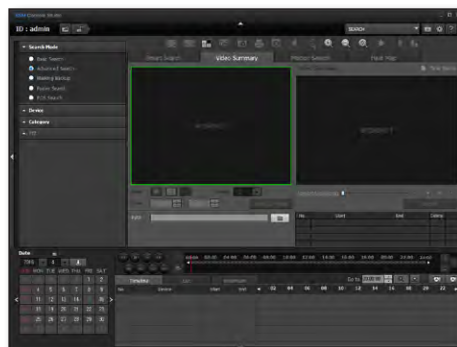

Motion Search

1. Switch to the **<Motion Search>** mode of **<Advanced Search>** and select the device to search in the **<Device>** list.
2. Set search year and month, and click [] button. Dates with recorded data are marked in the calendar. Select one to display data in timeline list.
3. In the timeline list, select a desired data item.
4. Use timeline bar to control preview display.
5. Specify the start time and end time for thumbnail view.
 - Up to 60 minutes can be assigned with start and end times.
6. Set the time interval.
 - Search Region Setting
 - Specify the search region by dragging the mouse to the right and down. Cancel the selection by dragging the mouse in the reverse direction.
 - The region can also be specified by clicking each cell.
 - All regions are selected or canceled by clicking **<Select All>** or **<Cancel All>**.
 - In case the selected device supports motion detection, check **<Motion Search>** checkbox for motion search. For other devices not supporting motion search, the button is disabled.
7. Click [**Search**] button.
8. Select a searched thumbnail to start playback in preview screen automatically.

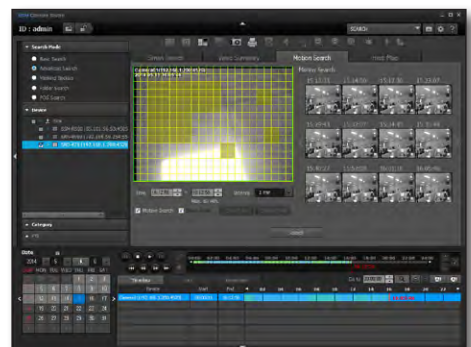
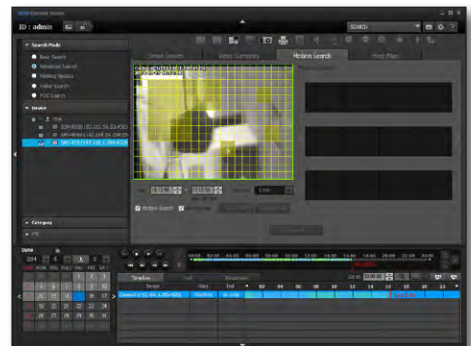
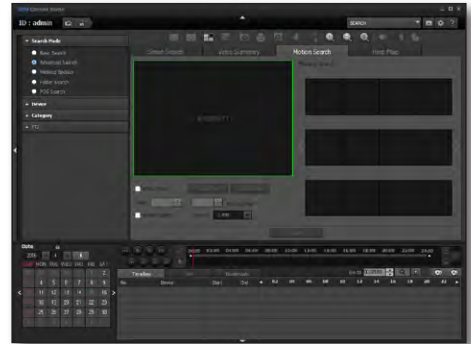

search viewer

Heat Map Search

Select a region on the image to detect the motion of an object in a specific time band and display how many movements were detected in each region.

 This is a function that is supported at SUNAPI NVR.

1. Switch to the **<Heat Map>** mode in **<Advanced Search>** and select the device to search from the **<Device>** list.

2. Select the year and month to search and click the [] button.

Dates containing data are displayed. When a date is selected, the data are displayed in the time-line list.

3. Select the data from those displayed in the time-line list.



4. Adjust the time-line bar to set the preview image.

5. Select a search region and specify the search time and search format.

- Setting the Search Region

- Specify the search region by dragging the mouse to the right and down. Cancel the selection by dragging the mouse in the reverse direction.
- The region can also be specified by clicking each cell.
- All regions are selected or canceled by clicking **<Select All>** or **<Cancel All>**.

6. Click the [View Heat Map] button.

- After the heat map search is completed, different colors are displayed according to the number of movements detected.
 -  : Redder colors means more movements detected.
- Check the results of the smart search and double click the search results to replay the selected image.
- Up to 500 smart search lists can be checked. Click the [] button to navigate between pages.

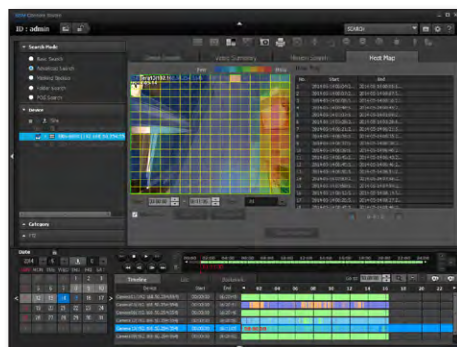
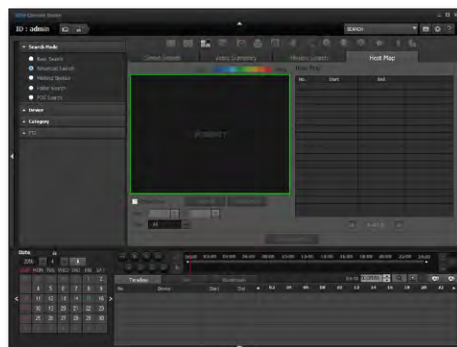

MASKING BACKUP

The mask operating for a specific period is added to the image to back up the image and audio.

Masking Backup

1. Select <Masking Backup> mode in the search mode.
2. Set the search condition.
 - Time : Enter the time for backup.
 - Region : Set the mask region to back up.
 - Path : Specify the backup path.
 - Password : Select whether the password will be used and set the password.
If password is to be used, set the password and confirm it.
3. Click the [Backup] button.

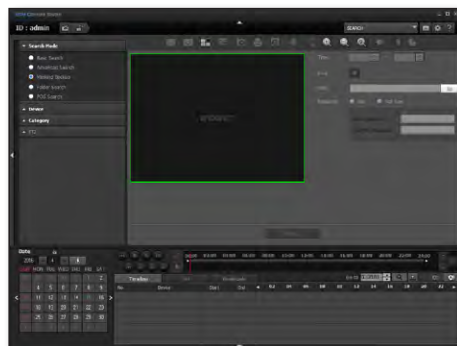

To Set the Mask Region

1. Click [].
2. To set the mask region, click the position of the upper left vertex of the rectangle on the image window, move the mouse then click the point of lower right vertex of the rectangle.
3. Set the mask operating time and click the <OK> button.
 - When the mask region and mask operating time are set, the recording of the selected region for the selected time is not saved.
 - Up to 32 masks can be set.

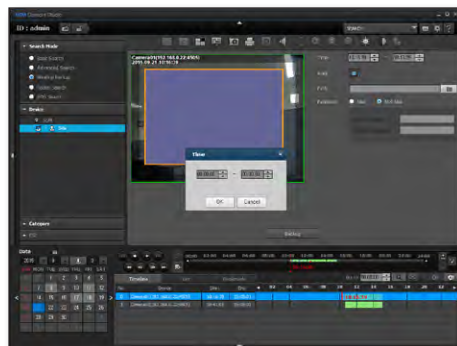

search viewer

FOLDER SEARCH

Search for the data in the folder which contains the data that were saved as SEC files in the PC used for SSM Console execution.

Searching Folders

1. Set to Folder Search mode and select a folder from <Folder> list.
Resulting footages are automatically listed in the timeline list.
2. Select a desired data from the timeline list.
3. Use playback control to play selected data.



- If the selected folder has more than 64 SEC files, then the popup window will ask you to select the files to be played. But if you double click on the timeline, you can play a maximum of 16 sets of video at a time.
- If the SEC file you want to play video for has a password, then the popup will prompt you to enter the password. You must enter the correct password before you can play the video.

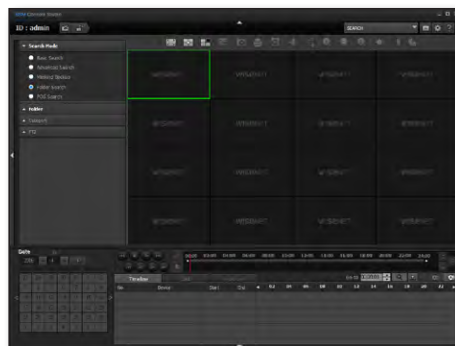

POS SEARCH

You can search POS records based on time and text keyword.



-  ■ The Search function is available only for the device supporting the POS function.

Searching POS data

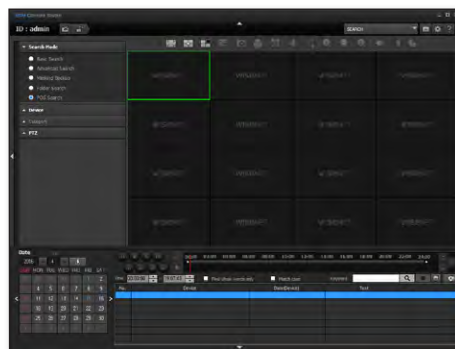
1. Set to POS Search mode and select date and time for your search.
2. Enter a search <Keyword>.
3. Set the search condition.
 - Find whole words : If not selected, blanks between keywords act as AND operator.
Ex) If entered "Cash 2500", finds data contains both "Cash" and "2500" from the database.
 - Match case : If selected, the search becomes case sensitive, distinguishing upper and lowercase letters.



4. Click [] button.
5. When you click a search result on the list of POS search results, a stop screen of the first camera is displayed.
6. When you double-click a search result on the list of POS search results, a video in which a POS event is generated is played.
7. When you play a POS keyword search result item, the content of the applicable receipt in addition to the video is displayed. (Function that is supported by NVR.)

-  ■ When you choose to fast play the video, the receipt is played fast as well.
Up to 64 times fast play is supported; reverse direction is not supported.
- If the video playback is stopped, the content of the receipt is stopped as well.
- You can save the POS research results in an Excel file format by pressing the [] button.

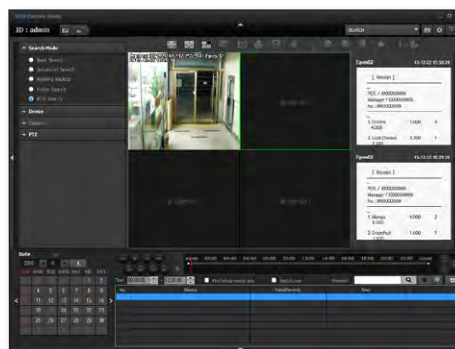

search viewer

BACKUP

You can back up the search data onto the computer that is running the program.

Backing Up Search Data

You can back up searched footage of selected period into a desired folder.

1. Click [] button.

The backup pop-up appears.

- Backup is only available for devices currently connected.

2. Select a channel from the backup window.

3. Click [] button to browse and set the desired backup storage path.

4. Specify the start time and end time.

5. Set the backup file format.

Backup supports "*.sec" and "*.avi" formats.

- AVI : A general video format. Can be played with Windows Media Player.
 - A new AVI backup file is created in the following cases.
 - When you change the video's resolution
 - When you change the audio or video codec
 - When the file size is greater than 2GB
- SEC : Samsung's proprietary format. Embeds self-executable video player with data.
 - Check <Use a Password in the SEC file> to set the password.



- The Microsoft Windows Media Player does not support AVI files having resolutions higher than 3Mega pixels. For high-resolution videos of more than 3 Mega pixels, SEC backup is recommended.
- You can back up the video at a designated time by selecting the <OneTime ScheduleBackup> check box.

6. Click [Backup] button to start backing up.

7. Click [Stop] button to stop backup in the middle.

8. To end backup, click [Close] button.

The backup stops and saves the file backed up at the moment, and closes the backup window.

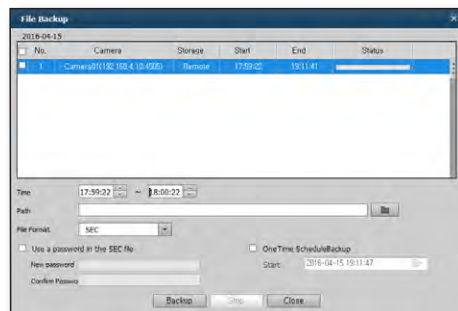

To use the onetime schedule backup function

1. Set the channel and path to back up and the format of a file to save in the backup window.
2. Select the "OneTime ScheduleBackup" check box and set the backup start time.
3. Click the [Backup] button and a onetime schedule backup status window will launch.
4. Click the [] button and you can check the onetime schedule backup status.



- When the [Pause] button on the lower left section is clicked, the Backup process is stopped temporarily. When the [Restart] button is clicked, the Backup is restored.
- Before the time at which the initially set onetime schedule backup is run, you can change the settings such as backup data type, date, time, etc.
- You can select and delete an item that has not been backed up yet in the list of <View OneTime ScheduleBackup Status>.

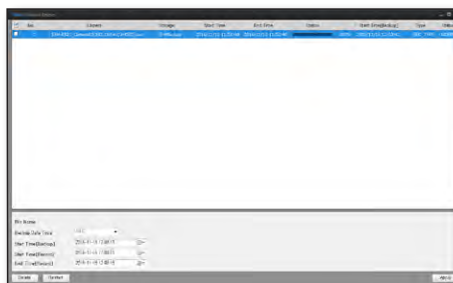
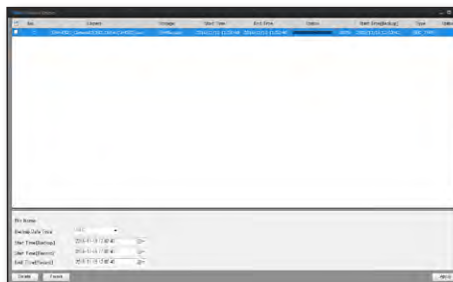

google map viewer

You can register equipment and inter-operate the video monitoring and event through inter-operation with Google Maps.

On the Select a Viewer menu at the top right of the SSM Console main screen, select the [GOOGLE MAP].

NAMES AND FUNCTIONS OF GOOGLE MAPS VIEWER SCREEN

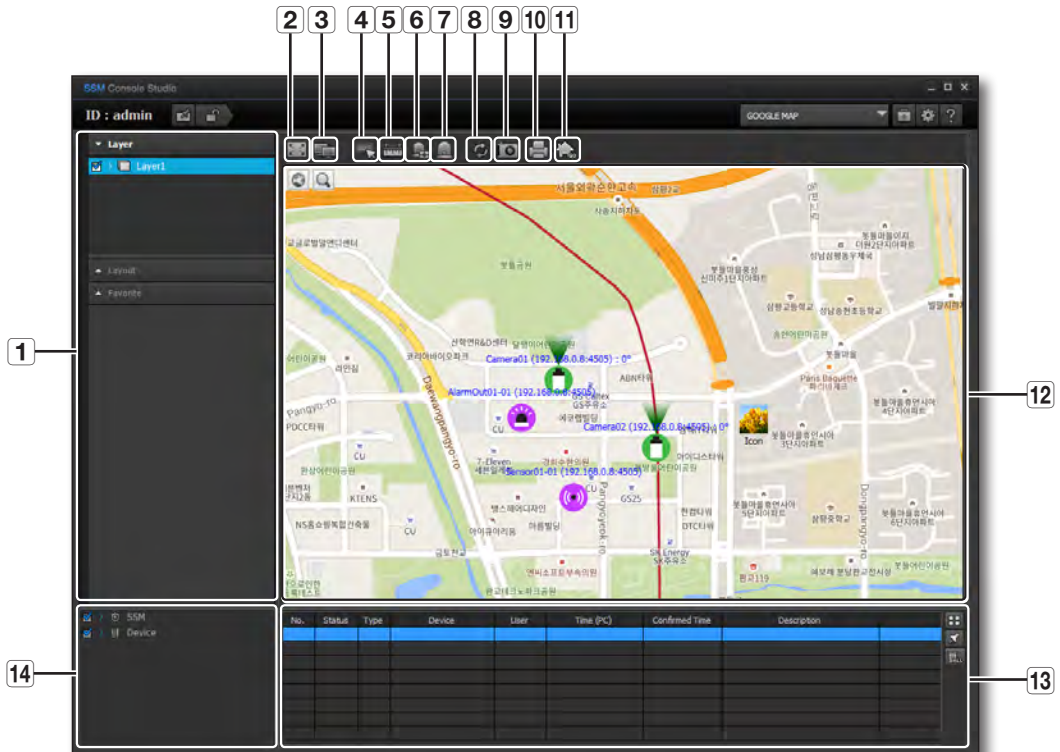

Item	Description
1	List Menu Displays the list set for each menu.
2	Full Screen Enlarges the video screen to the full size of the screen.
3	Multi Monitor You can watch the video using an additional monitor. Drag and drop a selected camera on a multi monitor window to watch the video. For more information about how to use a multi monitor, refer to "Live Viewer > Layout" on page 117.
4	Multi Selection You can select multiple icons on the map.

Item		Description
5	Measure the distance	You can check the distance by clicking locations on the map.
6	Inter-operate Events	The map is relocated to a location where the event is generated.
7	Initialize Events	Event indicators in all video windows are turned off.
8	Refresh	Refreshes the map.
9	Save the Screen	Captures and saves the map screen.
10	Print the Map	Prints the map screen.
11	Move to Home Position	Moves the map to the designated home position.
12	Map	Shows the Google Maps.
13	Event List	Displays an event generated in a connected device.
14	Select an Event	You can select the type of an event to be added to the event list.

google map viewer

NAMES AND FUNCTIONS OF GOOGLE MAPS

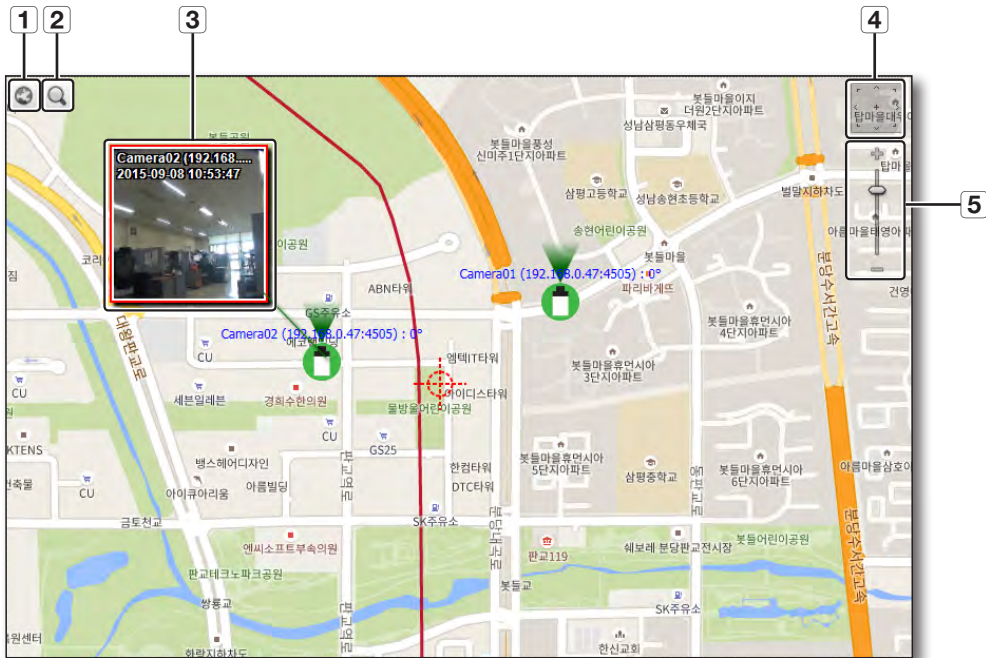

Item	Description
1 Switch to Satellite Map	Switches to satellite map mode. Clicking again while in satellite map mode returns to road map mode.
2 Search	You can move to a desired location on the map by searching an address. <ul style="list-style-type: none"> For more information about searching an address, refer to "Search Address" (page 94).
3 Create a Video Tile	After double-clicking the camera icon, a video tile appears.
4 Map Positioning Controller	When you hover the mouse pointer over the top right of the video window, the positioning controller appears. Click one of the arrows on the controller, and the map will move in the selected direction.
5 Zoom In/Out	When you move the mouse pointer over the top right of the video window, the Zoom In/Out controller appears along with the positioning controller. You can zoom the map in/out by adjusting the controller.

LAYER

Devices and icon list configured in the SSM configuration Manager are output on the layer tree, and you can choose whether to show them on the map.

Double clicking on the layer tree moves to the location of the corresponding icon.

View Layer

You can select and control the object registered in the map.

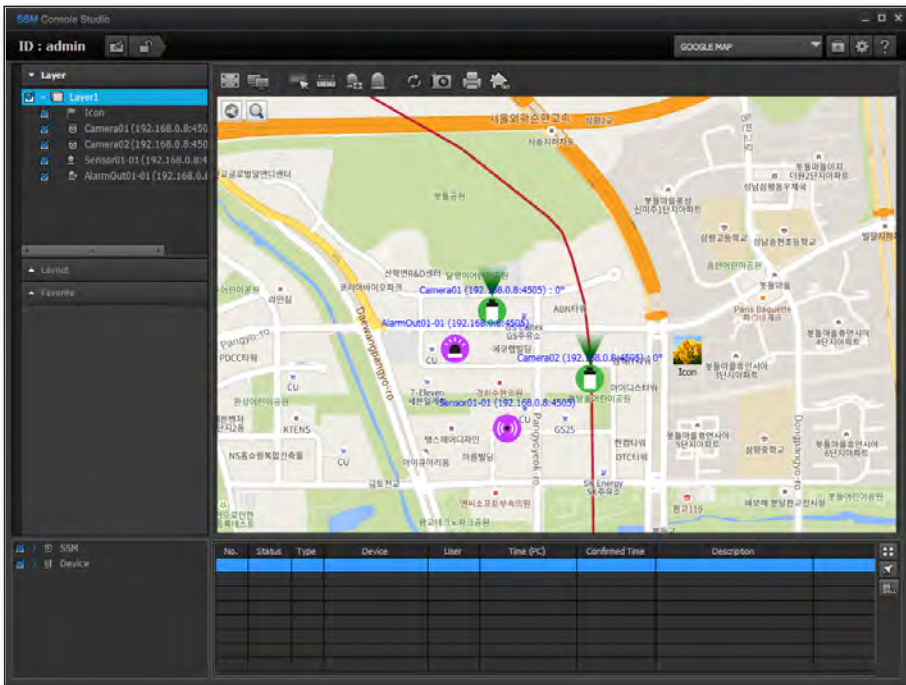

Search for a Registered Object

- Click <Ctrl + F> while on the layer tree to launch the <Find Object> pop-up window.
 - The pop-up window applies only when any highlight exists in the layer tree.
- Input an object to search and click the <Next> button.
 - If no search result is found, the <Next> button is disabled.

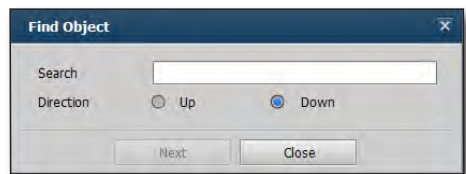

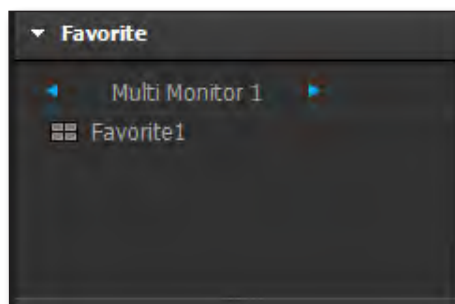

Favorites

A list of favorites added in the live viewer is displayed.
For more information, refer to the "**Live Viewer > Favorites**" section (page 122).



Configure Google Maps

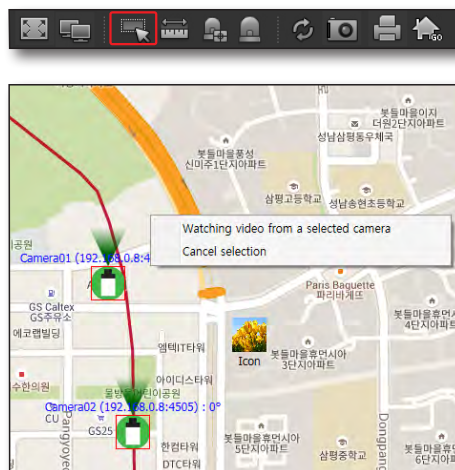

Select Multiple Camera Views

1. Click the [] button.
Click and drag to select multiple objects.
 2. On the map, select a camera icon with the mouse, then you can select additional icons while pressing the [Ctrl] key.
 3. After selecting multiple cameras, right-click on the map to launch a **<Watching video from a selected camera>** pop-up window.
 - Watching video from a selected: Videos searched are played in the pop-up window.
 - Cancel Selection: All the areas currently selected are deselected. You need to select again.
-  ■ After selecting multiple cameras, you can view the videos by dragging and dropping the camera icons on the console monitor window and the video wall.



google map viewer

Measure a Distance

1. Click the [] button.
Click the points on the map to measure the distance between them, then a measured distance is displayed.
2. When you click the [] button again, the distance disappears.
 - Up to 20 distance measurements are available.

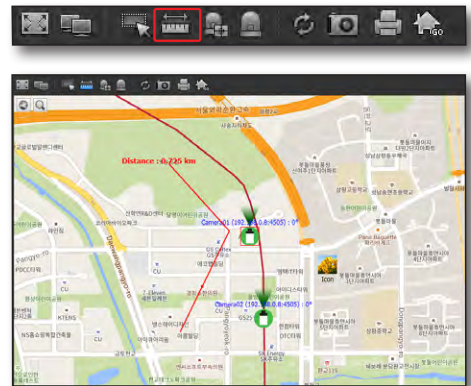

Inter-operate Events

When you click the [] button, the map moves to the location where the event is generated.
The icon of the camera sensor generating an event flickers, and the color of the borders of the play window are changed.

Initialize Events

When you click the [] button, the flickering of the icon where an event occurs and the color of the play window borders are initialized.

Refresh

Click the [] button to load a new map.

- Google Map settings changed in the SSM Configuration Manager are not applied to the GoogleMap Viewer in real time. You need to click the refresh button for the changed settings to be applied.

Save the Screen

Saves the current map screen to a designated path.
You can select a file format when designating the path.
(JPG or BMP file format is available)

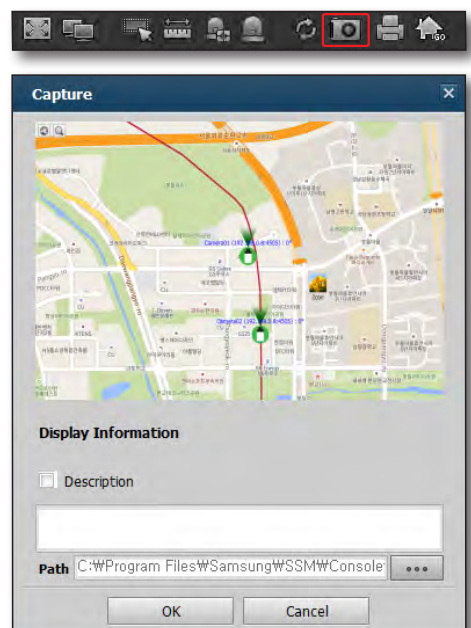

Print Screen

Prints out the current map screen.

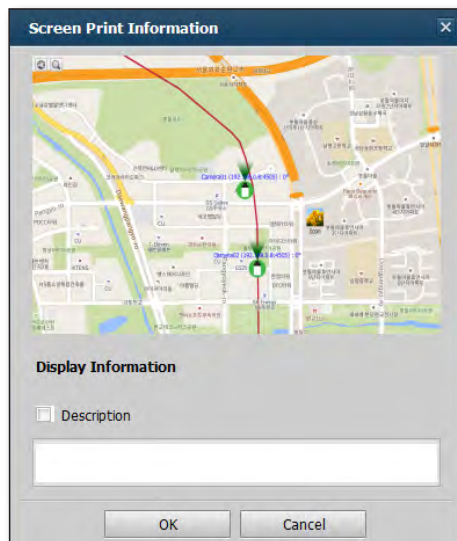

Move to Home

Clicking the [] button moves the map to a designated home position.

plug-in viewer

PLUG-IN VIEWER

From the Select a Viewer menu at the top right of the SSM Console main screen, select **[Plug-in]**.

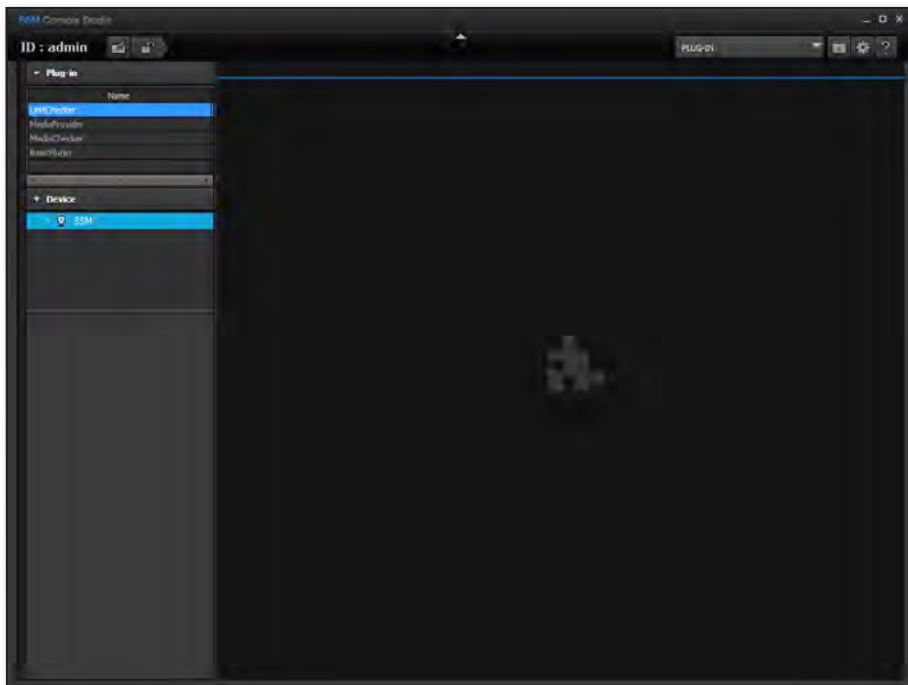

To register a plug-in

Copy a plug-in file to the <Plug-in> folder.

- Check the "SSM>Console>plugins>plugins" path.

To delete a plug-in

Select and delete a desired plug-in file in the <Plug-in> folder.

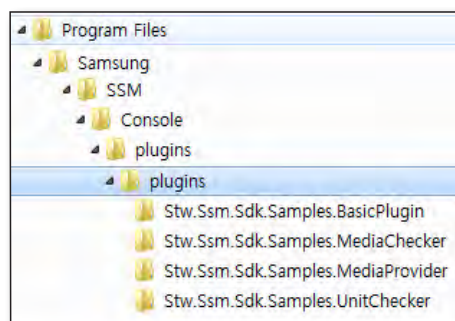

To run/exit a plug-in

1. double click a plug-in to run in the list of plug-ins, and the selected plug-in will run.
 - You can run multiple plug-ins at once.
 - When multiple plug-ins are running, they are shown on the tab control screens at the top of the plug-in area.
2. You can drag and drop a plug-in to move it to a separate window.
3. Click [X] on the plug-in tab to close and the plug-in will be closed.
 - After exiting and running the plug-in viewer, the plug-in before exiting the viewer will be automatically run.

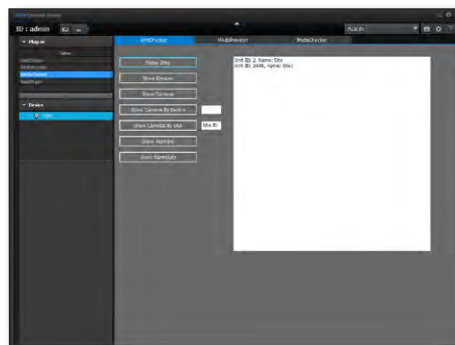

To set a plug-in

1. Select and right-click a plug-in to set.
 - Settings of a plug-in that is running are deactivated.
 2. A settings pop-up window is launched.
 3. Enter the information for settings items such as ID, password, IP, port, etc.
 4. After completing the configuration of settings, press the [OK] button.
- 
 ▪ For more information about the SDK, please visit the following URL.
https://step.hanwha-security.com/kor_EN/HelpDesk/QNA_Write.aspx

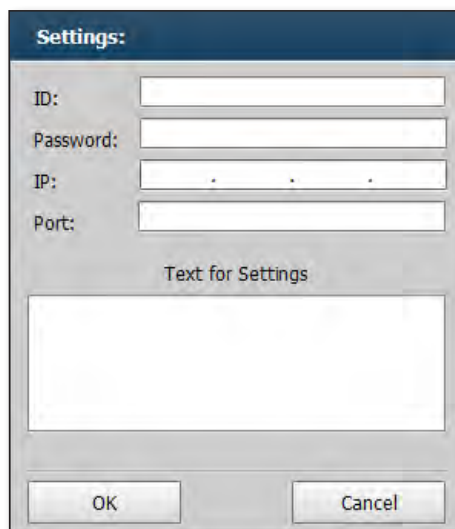

setting console

SETTING SSM CONSOLE

Environment

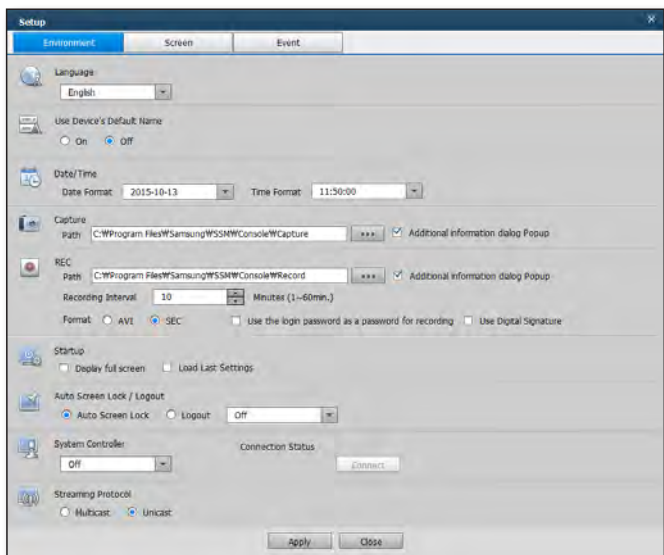

Language

Sets the language used for Smart Security Manager's user interface.

Use Device's Default Name

When it is checked, the name of the camera registered to the device is displayed in the list or the screen.

Date/Time

Set the date and time format displayed on OSD.

Date / Time indication is based on the time of running the pop-up window.

- Date formats
 - 2010-04-19 (yyyy-mm-dd)
 - 04-19-2010 (mm-dd-yyyy)
 - 19-04-2010 (dd-mm-yyyy)
- Time formats
 - 08:06:04 (hh:mm:ss)
 - 08:06 (hh:mm)

Capture

You can set the captured image file's path.

- Path : Shows the current file path, click [] button to set to another file location.
 - Click <Additional information dialog popup> to display saved path and additional capturing information on a popup window separately when capturing a monitoring window.

REC

Set the selected recording data's file path and recording interval.

- Path : Shows the current file path, click [] button to set to another file location.
- Recording Interval : Sets how long the recording will continue.
- Format : Sets the file format for recording.
 - Click <Additional information dialog popup> to display saved path and additional recording information on a popup window separately when recording a monitoring window.
 - If you check <Use the login Password as a password for recording>, you can use the login password for recording.
 - When the <Use Digital Signature> check box is selected, a digital signature is applied to the recorded backup file to prevent falsification.

Startup

Configures the screen display and its settings when the program is started.

- Display full screen : On the program's startup, it fills the entire screen automatically.
- Load Last Settings : When restarting, it loads the last displayed camera's video layout.

UI Auto Lock / Logout

- UI Auto Lock : If there is no keyboard or mouse action for the specified period, it locks user interface automatically which prevents unintended access.
- Logout : If there's no keyboard or mouse action for the specified period, it logs out automatically to prevent unintended access.

System Controller

You can connect SPC-2000, SPC-7000 and AXIS-T8310.
Click the [**Connect**] button to check the connection status.

Streaming Protocol

You can configure the camera video streaming protocol.
You can choose between <Multicast> and <Unicast>.

setting console

Screen

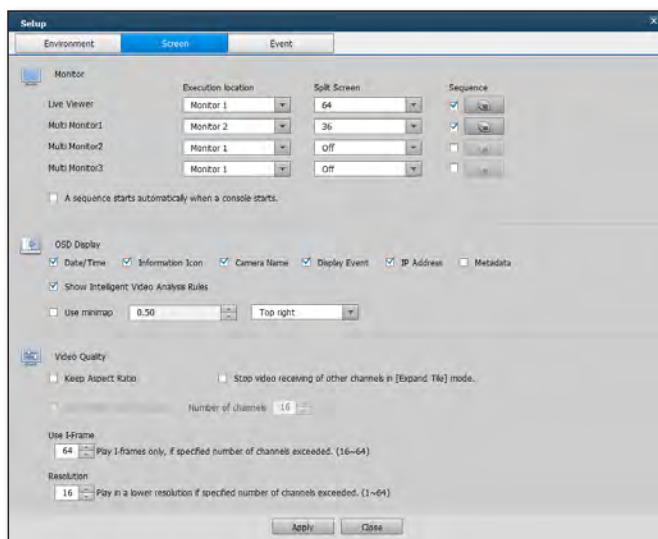

Monitor

The monitor layout can display up to 100 channels on a maximum of 4 monitors.

Execution location

Select the number of monitors to connect. Up to 4 monitors can be connected.

Split Screen

Sets the split screen mode for each viewer / monitor.

The available split screen modes differ by maximum number of channels and connected monitors.







- The default settings may not be appropriate to your configurations; user must configure the system appropriately for proper operations.

Sequence

Distributes camera feeds to fit the selected split screen mode in sequenced order automatically, at the specified duration.

- Sequenced mode is available only for a camera layout.

To define sequence

1. Click [] button on the top right corner of the target monitor.
2. To add a layout, click [] button. To delete a layout, click [] button.
3. Click <Dwell Time>'s [] button and set the dwell time of each layout added.
4. When done with setup, click [OK] button.
5. To apply the sequence mode, check the checkbox in front of the sequence setup button.
 - To start the sequence function automatically when the console is started, click the check box.

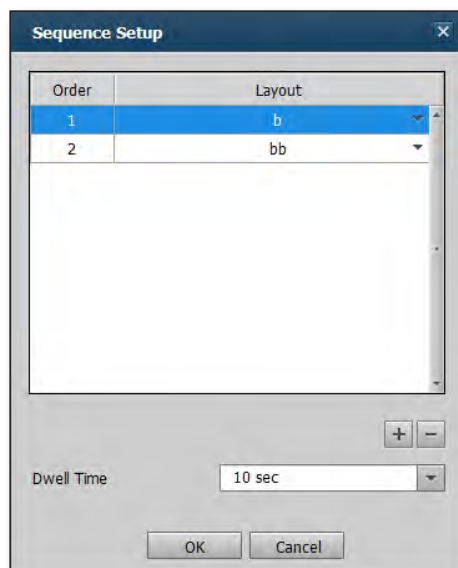

OSD Display

You can select the information (OSD) displayed on the monitor.

- Check the checkbox of <Use mini map> to specify the use of mini map.
 - Adjust the value between 0.3~1.0 to set the size of the mini map.
 - Select upper right/lower right/upper left/lower left to set the position of the mini map.

Video Quality

Use I-Frame

Set the number of channels, the I-Frame mode will be applied for more than the specified channels.

It is applied to each monitor of each viewer.

It is used to avoid system overload of multi-channel video monitoring.

- **What is I-Frame?**
Video compression methods using H.264 and MPEG4 codecs produce compressed video of one base frame (Intra-frame) and multiple predictions (predicted frames) only containing differences between each frame's previous one.

setting console

NVIDIA CUDA decoder is used

When CUDA decoder is supported, whether it is used or not and the number of applied channels should be set. When the number of applied channels is exceeded, the basic SW codec is used.



- A 64 bit OS environment is recommended for CUDA decoder usage.

Resolution

Set the number of channels, low-resolution will be applied for more than the specified channels for better communication.

It is applied to each monitor of each viewer.

Event

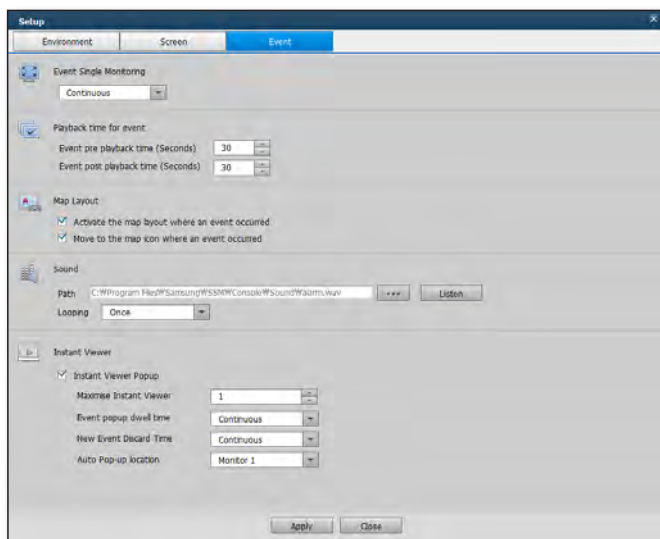

Event Single Monitoring

Upon an event, the Live Viewer monitoring screen automatically switches to Single mode with the event-generating channel for the specified period, which returns to previous mode afterwards.

Playback time for event

You can set the event play time by event pre-play time (seconds), event post-play time (seconds) and pre-play time (seconds).

- Event pre playback time (Seconds)
 - Specifies the start point of the video to be played on the instant viewer (Playback) by designating a specific length of time in seconds before the current position.
 - Specifies the start point of the video to be repeatedly played on the instant viewer (Playback) by designating a specific length of time in seconds before the current position.
 - Specifies the start point of the video to be sequentially played on the instant player by designating a specific length of time in seconds before the current position.
- Event post playback time (Seconds)
 - Specifies the start point of the video to be repeatedly played on the instant viewer (Playback) by designating a specific length of time in seconds after the current position.
 - Specifies the start point of the video to be sequentially played on the instant player by designating a specific length of time in seconds after the current position.

setting console

Map Layout

If this option is set and an event occurs while viewing a map layout, the view automatically switches to the corresponding map which contains the event-generating device's icon on it.

Sound

Set the sound device for the event, and how the sound repeats.

Instant Viewer

Selects whether to launch a pop-up window when an event occurs, and sets the number of instant viewers to run when a pop-up window is launched, as well as the duration of the pop-up window to be displayed.

SSM service manager

You can check SSM related services, and stop them.
The Service Manager should run while the Smart Security Manager is running at the same time, and an icon appears in the task tray.

SERVICE MANAGER

Resides in the task tray, and provides access to Smart Security Manager services.

Managing the Services

Select the icon and right mouse click.
Service menu should appear.
You can start or stop services.

- Start the SSM Console : Runs SSM Console program.
- Start Service : Starts Media Gateway and System Manager services.
- Stop Service : Stops Media Gateway and System Manager services.

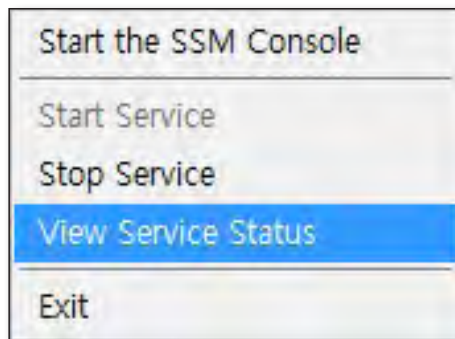

Service Status

Click [Service Status] to open SSM Service Manager information dialog.

- Start Service : Disabled if the service is running.
- Stop Service : Disabled if the service is stopped.
- OK : Applies the changes, and closes the window.
- Cancel : Does not applies the changes, and closes the window.

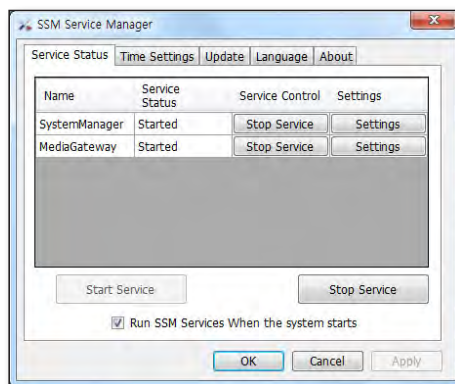

SystemManager

- Port : The port of the system manager is changed.

SSM service manager

Media Gateway

- NIC #1 : The media gateway IP, console, CM, etc. saved in SM DB are connected to this NIC.
- NIC #2 : If it is set, the equipment is connected to the NIC.
- Port : It is the port used for connecting the client.
- SSLPort : Port to be used for SSL connection
- HTTP port : This port provides the CGI Web service to the mobile viewer.
- RTSP port : The rtsp port provides the image to the mobile viewer.

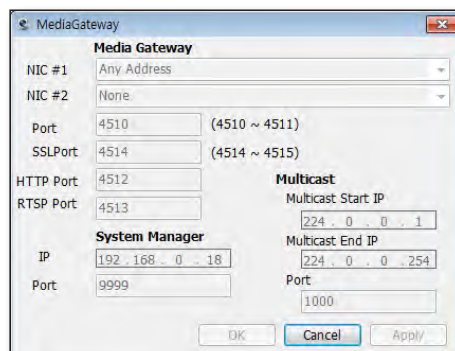

System Manager

- IP : SM IP for the connection to MG.
- Port : SM port for the connection to MG.

Multicast

- Multicast Start IP : Start IP of multicast
- Multicast End IP : End IP of multicast
- Port : Multicast port of a device to which the MG is to be connected

Time Settings

You can set the computer installed with SSM to be the NTP time server, and its checking frequency.

- Use as Sync Server : Other PCs or devices are synchronized with the time of this PC.
- Use Sync Time : This PC tries synchronization to the input address at the specified interval.

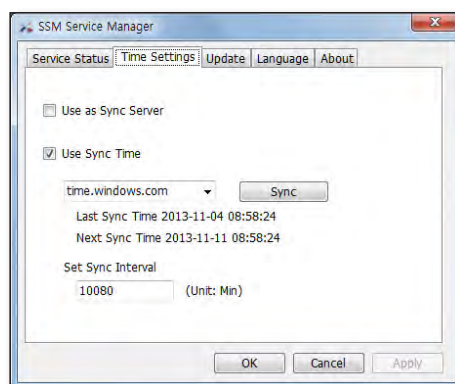

Updater

If the server has the latest version, the update list will appear. A user can check the release note and the content of the latest updates before deciding whether to proceed with the updates.

Click on the <Use Auto Update> and set the auto update settings.

- When "Automatic Updates" is selected or the 'Update' button is clicked, the updates are automatically performed and patches are executed when the updates are needed.

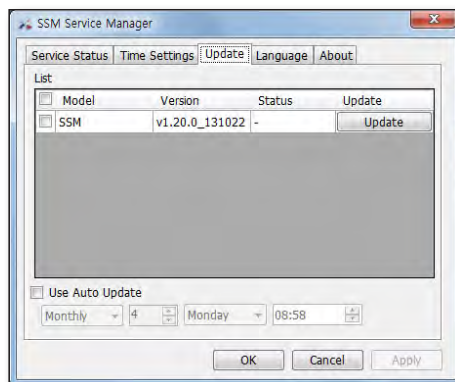

Automatic Update Setting

Updates can be checked automatically by setting the update checking period.

- Select [Update] in [SSM Service Manager].
- Change the setting in the setting window and click the [Apply] button.

Selecting the Automatic Checking Interval

- Updates can be checked for daily.

- Select Daily.
- Select the automatic update time.
ex.) The figure in the right shows the update set for 10:00 am each day.

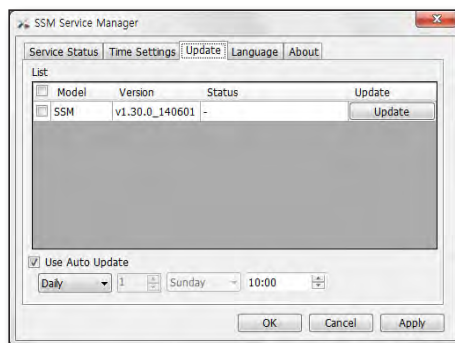

- Updates can be checked for weekly.

- Select Weekly.
- Select the day of the week for automatic updates.
- Select the automatic update time.
ex.) The figure in the right shows the update time set for 10:00 am on each Sunday.

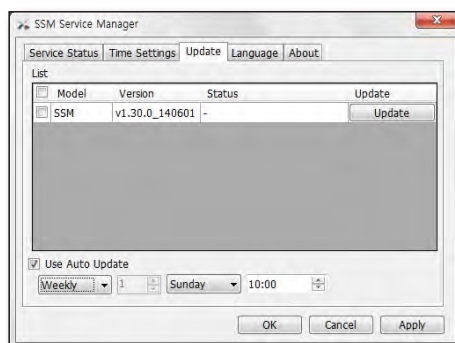

SSM service manager

- Updates can be checked for monthly.
1. Select Monthly.
 2. Select the date for automatic updates.
 3. Select the automatic update time.
ex.) The figure in the right shows the update time set for 10:00 am on the first day of each month.

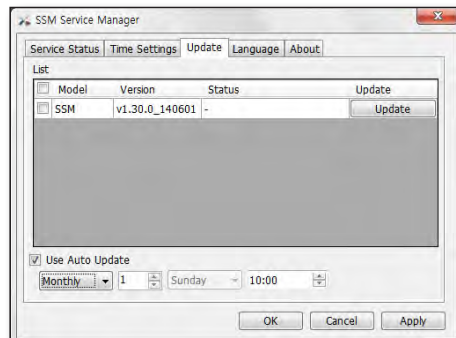

Language

You can set the program language.

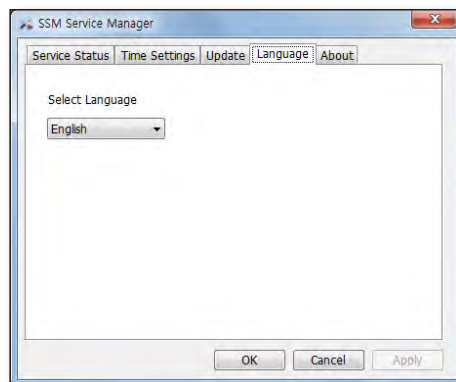

About

Shows the Service Manager's version information.

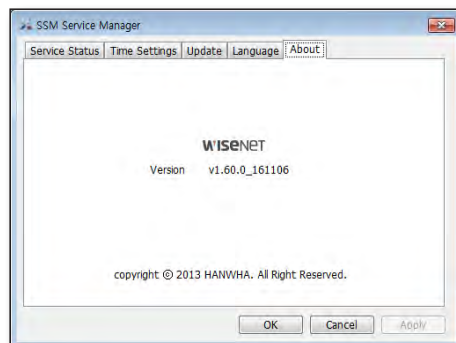

SSM Recording Server

SSM RECORDING SERVER SERVICEMANAGER

You can check the execution status of the SSM Recording Server related service and terminate it if you want to. You can change the SSM Recording Server related settings. As soon as the SSM Recording Server runs, the service manager program will run. The task bar will automatically show the icon.

Service manager

It is in the task bar and manages the SSM Recording Server service.

Service management

Select an icon and right click with your mouse button on it. Service menu will appear.

You can start or stop the service.

- Start the Recording Server service : Starts the service.
- Stop the Recording Server service : Stops the service.

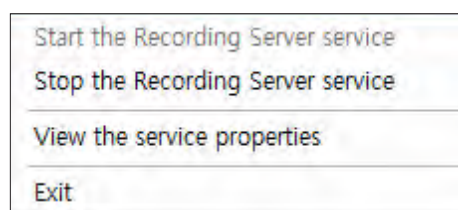

Service starts

Click on the [View the Service Properties] to launch the Recording Server Service Properties window. You can check the current status of the Recording Server service.

- Start the Recording Server service : Starts the service.
- Stop the Recording Server service : Stops the service.
- Unregister MediaGateway : Cancel registration of the Media Gateway and initialize the Media Gateway information box.
 - Recording Server can be registered and accessed in a single Media Gateway.

If the Recording Server is already registered and connected to the Media Gateway, and if you want to register in another Media Gateway, you need to delete (cancel registration) the Recording Server in the SSM.

When registration is cancelled, the Media Gateway information is initialized. So, you can register in another Media Gateway.

If the registered Recording Server is not connected to the Media Gateway, you need to delete the Recording Server from the SSM and click on the [Unregister MediaGateway] button in the Recording Server Service Manager to initialize the registered information.



SSM Recording Server

NTP Client

You can set the NTP server to synchronize the time of the PC where the Recording Server is installed.

You can change the setting to make sure time synchronization is performed periodically.

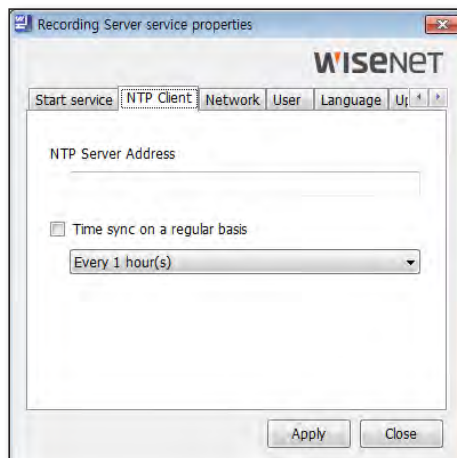

Network

You can retrieve the Recording Server setting information from a file.

Setting the number of networks used

You can set the number of networks used.

1. Check the network to be used.
 - 1 used : Uncheck network 1 used.
If one network is used, it means that a single network will communicate with the SSM and the device.
 - 2 used : Check network 2 used.
If two networks are used, it means that network 1 will communicate with the SSM and network 2 will communicate with the device to evenly distribute the communication load.
2. Click on the [Apply] button to save changed settings.

Network selection

Select network 1/2 from the list of available networks on the PC.

- If you want to change the network setting, the Recording Server service will resume.

Port setting

You can set the system port range that the Recording Server will use.

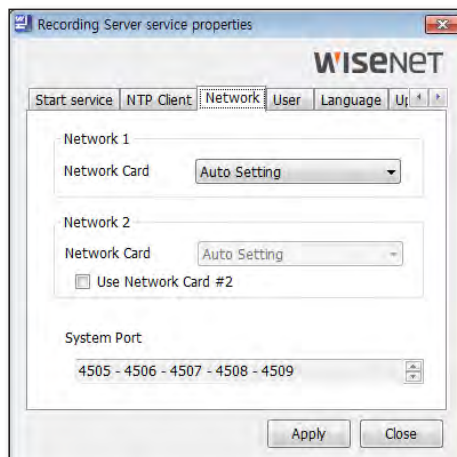

User

You can change the password for a user who will access the Recording Server.

- Password changes : Click on the **[Change pwd]** button to switch to a new password.



Language

You can select the language to display the program (SSM Recording Server service manager and update manager).

- Basically, it is automatically set to the OS language. If not available, it is set to English.

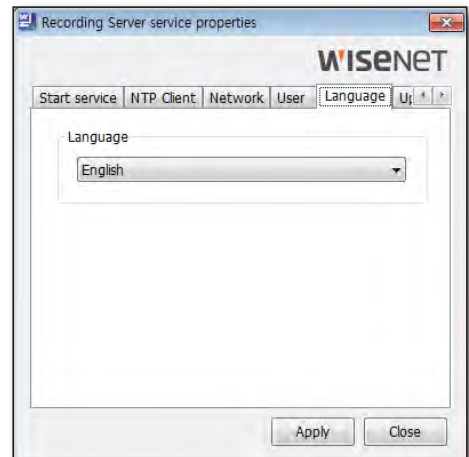

SSM Recording Server

Update

You can set the updates of the recording server.

You can configure automatic update settings.

1. Select the <Use AutoCheck> check box.
2. Select an interval (daily, weekly, monthly).
3. Enter a date and time to check.

-  You can check updates manually by clicking the <Check New Version> button.

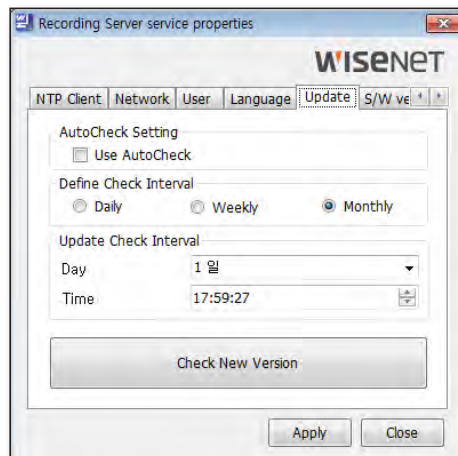

To run the update

1. Check the update either manually or automatically and a download window will open if there is a new update.

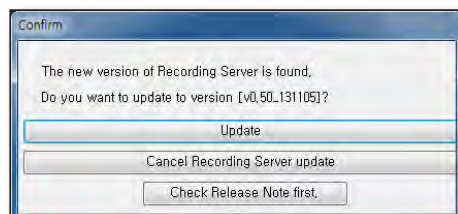

2. Select the [Update] button to download the installation file.

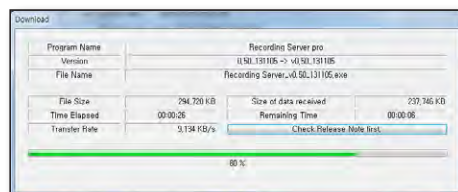

3. When downloading is complete, you will be asked whether you wish to install the downloaded file now.
 - If you choose **[No]**, the installation window will launch at the time of the next update check.
 - If you choose **[Yes]**, all the recording server applications are automatically closed and the installation process will start.

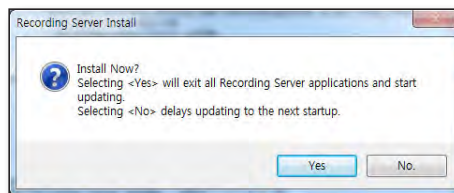

S/W version

Shows the latest version information for the SSM Recording Server.

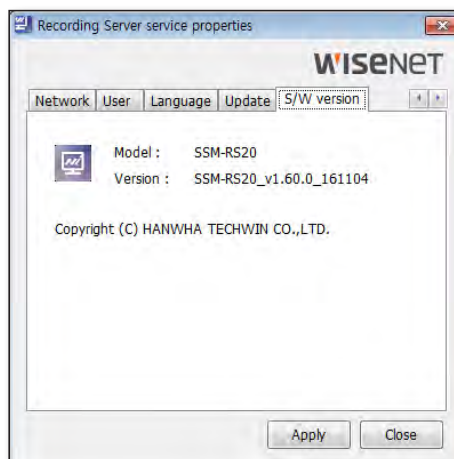

SSM HA

SSM-HA DESCRIPTION

SSM-HA is a program to perform the failover function of SSM.

When the media gateway, recording server or VMG of the PC in operation cannot be operated properly due to network failure, it is replaced with a media gateway, recording server or VMG that is operated in Secondary(Standby) mode and copies the information of the target PC for recovery.

When the problematic operating PC is recovered, the information and videos saved in the Secondary(Standby) is restored to the Primary(Active) PC system via the fallback function to get it back on track.

- Coverage range
 - When disconnection occurs between the Primary(Active) client and the network
 - When the Primary(Active) client PC is out of order (power fail)
- Status check
 - Signal is received from the Primary(Active) client at intervals of 1 second.
 - If no signal is received for more than 20 seconds, the Primary(Active) client is deemed to be abnormal.

HA System Configuration

In SSM, HA is comprised of the following.

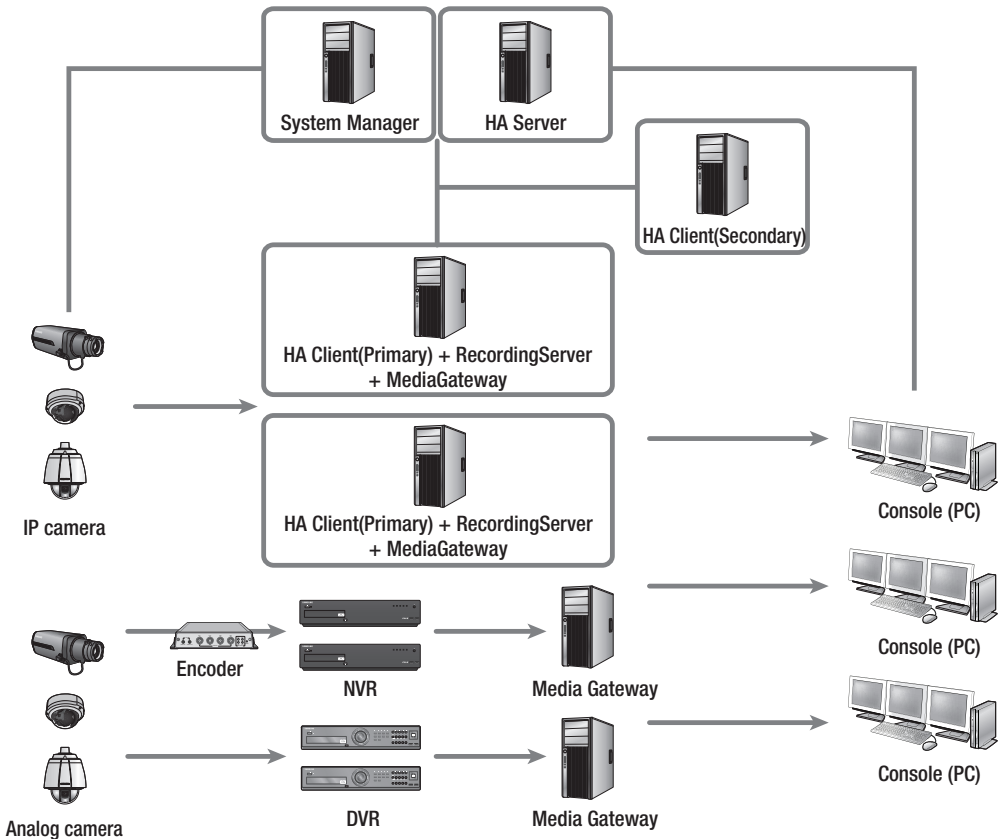

Example of configuring with 2 Primary(Active) units and 1 Secondary(Standby) unit

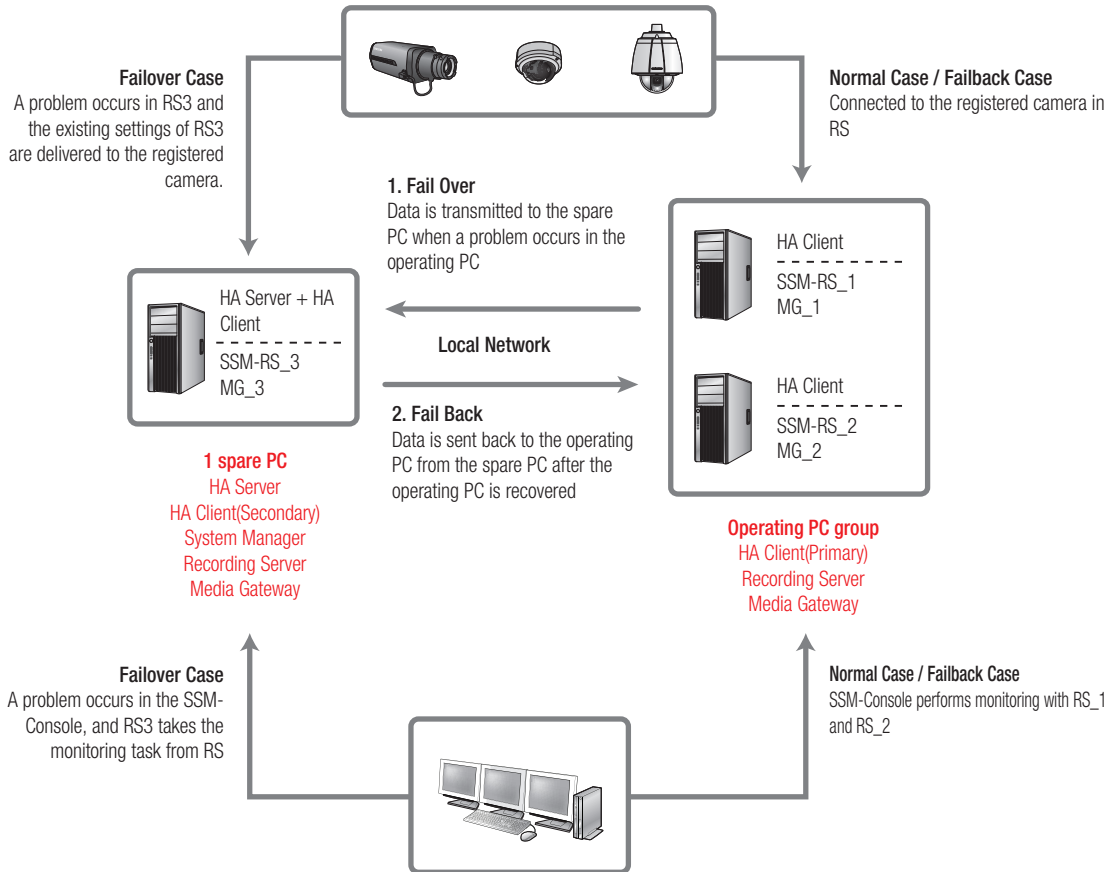

SSM HA

Example of configuring an actual IP with 2 Primary(Active) units and 1 Secondary(Standby) unit

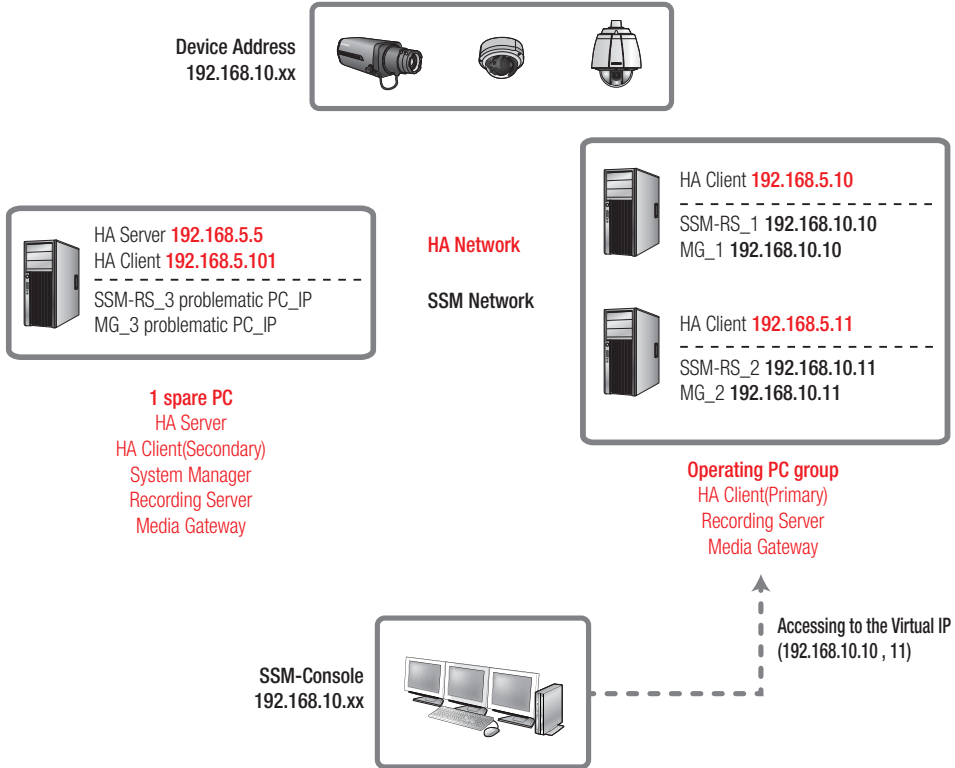

Operation at the time of failover

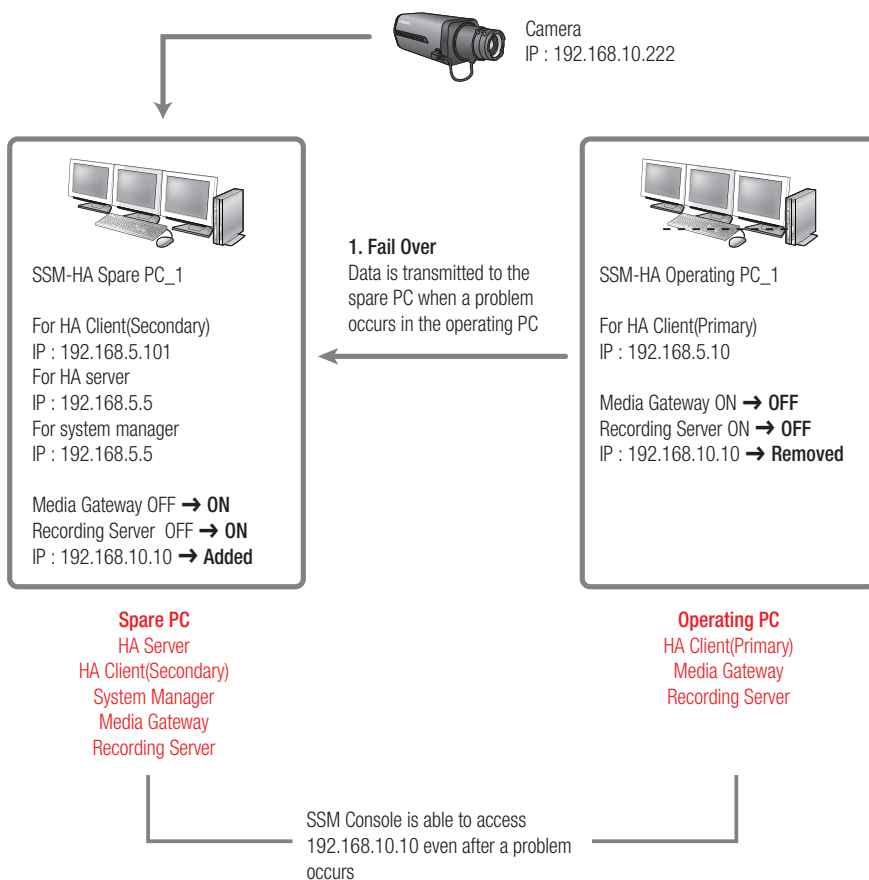

SSM HA

Operation at the time of failover

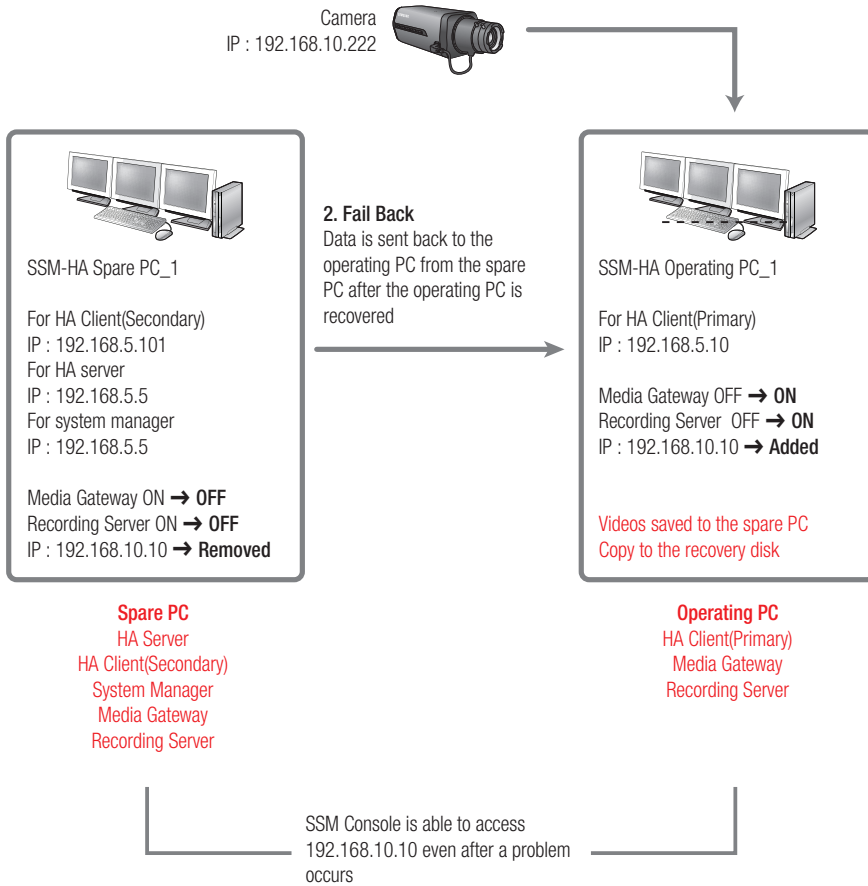

HA TERMINOLOGY AND INSTALLATION

Terminology

Term	Description
HA Server	Server module that manages the HA client It decides the fail-over or fail-back and transfers the event to SSM.
HA Client	A module actually executing the HA function in each PC. HA client has a Primary(Active) mode and a Secondary(Standby) mode.
Target Service	Refers to the service managed by the HA client. * Target Service : <ul style="list-style-type: none"> - Recording Server - Recording Server + Media Gateway - Media Gateway - VMG (VMD is configured as a separate PC)
Virtual IP	IP address to be used by the target service managed by HA
Failover	Procedure in which the HA Secondary(Standby) client substitutes for the HA Primary(Active) client when the HA Primary(Active) client is out of order
Failback	Procedure in which the HA Primary(Active) client returns to the original operation when it recovers from the failure
HA Client(Primary)	HA client that is operated in Primary(Active) mode
HA Client(Secondary)	HA client that is operated in Secondary(Standby) mode

HA Installation

Checking of Installation Environment

PC performance : CPU : Intel Core i5-4670 @ 3.40GHz, RAM : 8GB or higher
Hard Disk Drive : At least 2 SATA II 7200rpm hard disk drives (1 for the operating system and 1 for recording)
Operating system : Windows Server 2008 R2, Windows Server 2012, Windows 7, Windows 8, Windows 8.1

- The hardware specifications of the Primary(Active) client and the Secondary(Standby) client (including the number of disk drives and network cards) as well as their OS specifications should be identical.
- If the target service is not SSM-RS, a recording disk is not necessary.

SSM HA

SSM-HA Installation

Install **SSM-Version_Date.exe**.

- Select the Install HA option from among the SSM installation options and the HA installer will be run. When installing an HA, you can select either **<HA Server>** or **<HA Client>**.
 - When an HA has already been installed and is operated, you are required to perform installation in a disabled state.
 - Manual Execution of HA Manager (Automatically Executed during Reboot)
- Start - Program - Wisenet - HA - HA Manager

-  ■ HA Manager runs the HA Server and HA Client installed in the system, and prepares for the operation of web console.

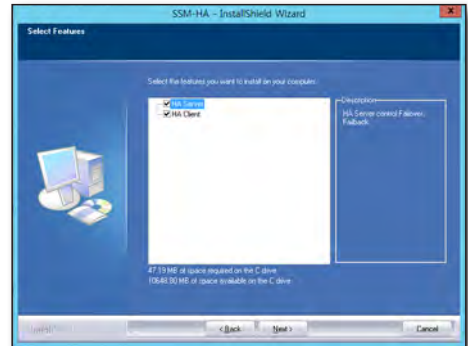

Confirm HA Server installation

You can run the HA Server settings program using the icon generated on the screen.

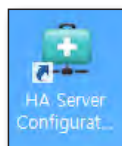

Double Click



Confirm HA Client installation

You can run the HA Client settings program by double-clicking the tray icon for HA Client.

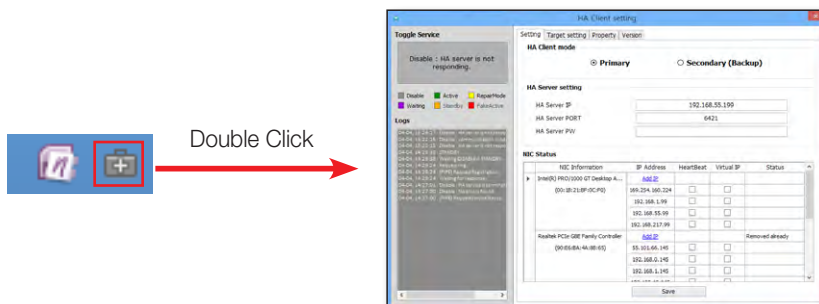

HA Setting

HA Server settings

1. HA server settings

- Server Network Card / IP / Port : Network access information to operate with the HA Server
- SSM SM IP / Port : Network access information to access to SSM System Manager
- Password: Password for the HA Server set at the time of installation (required when HA clients access the HA Server)

Enter information in all input fields and click the <ENABLE> button.

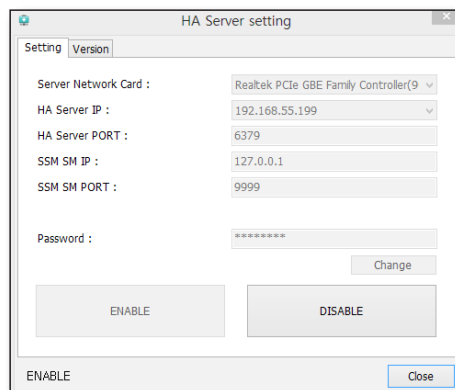

SSM HA

HA Client - Primary settings

1. Settings tab configuration

- On the Settings tab, select Primary.
- Enter an IP and port of the HA Server.
- In NIC Status, select an IP to be used for HeartBeat.
- Select a virtual IP of the target service (required to use an NIC that is same as the HeartBeat IP).
- Click the <Save> button to save the settings information.

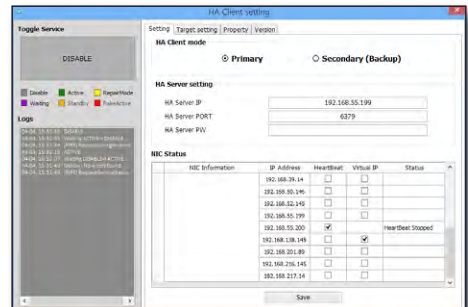

2. Target settings tab configuration

- Select a target service to use.
- Check whether the files used for the target service are loaded.
- Refer to information on how to configure network settings for each service, and configure settings so that the IP selected as a virtual IP is used by the target service.

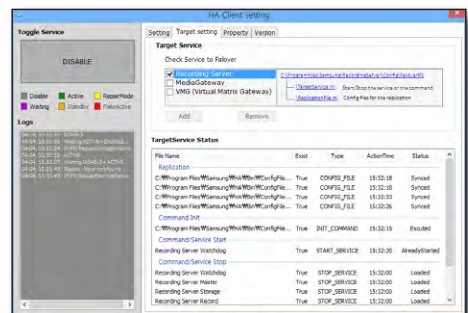

3. Enable

- Return to the settings tab.
- Enter the password of the HA Server.
- Click the <DISABLE> button and wait for a while to check whether the button changes to <ACTIVE>.

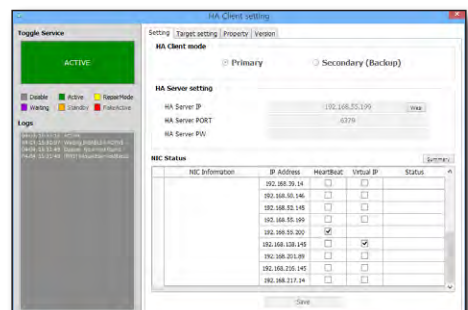

HA Client - Secondary settings

1. Settings tab configuration

- On the Settings tab, select Secondary.
- Enter an IP and port of the HA Server.
- In NIC Status, select an IP to be used for HeartBeat.
- For the virtual IP, select what is marked in the blank.
- Click the **<Save>** button to save the settings information.

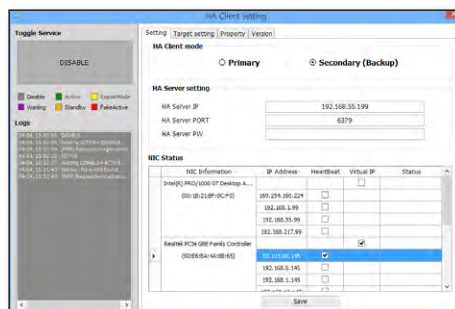

2. Target settings tab configuration

- Select a target service to use.
- Check whether the files used for the target service are loaded.

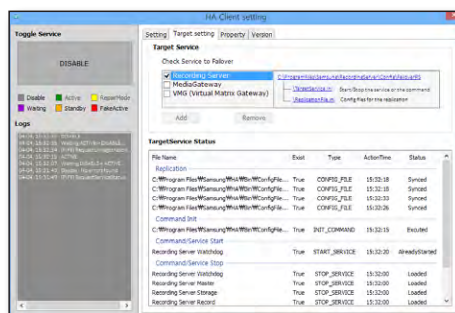

3. Enable

- Return to the settings tab.
- Enter the password of the HA Server.
- Click the **<DISABLE>** button and wait for a while to check whether the button changes to **<STANDBY>**.

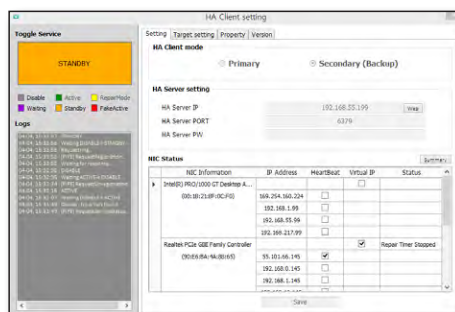

SSM HA

Recording File Recovery

1. Data Recovery Tab

- When failback succeeds, if there is a recorded file in the secondary agent, the recorded file is transmitted from the secondary to the primary.
- User can cancel or retry the transmission while the file is transmitted.
- To start the recovery, a restore disk (with at least 2GB of storage space) for the recovery needs to be assigned in advance in the recording server through the SSM configuration manager.

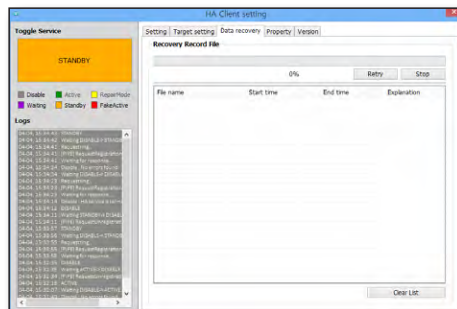

HA Web Viewer

1. Accessing HA Web

Desktop Icon in the Local PC



- Double click the HA Web Viewer icon on the desktop.

Input the URL ([http://\(HAServerIP\):8888/ha/loginpage](http://(HAServerIP):8888/ha/loginpage)) in the address box of the browser in a remote PC.

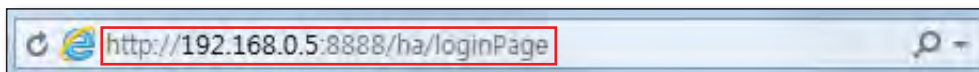

2. HA Web Server Login

- Select a language.
- Enter the password set during the HA installation and click the 'Login' button.

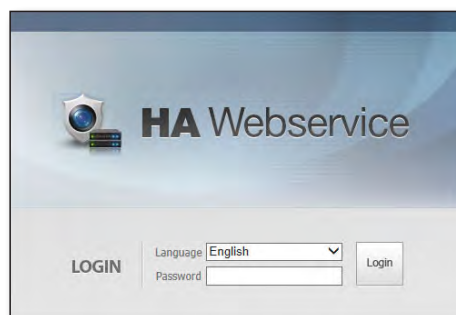

3. HA Web Server Setting

HA Server Setting and status informaton

- The setting of HA server in Web is the same as the above setting.

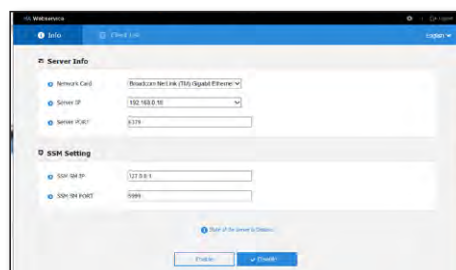

SSM HA

HA Client Login Information

- Click an IP address in the list to view the details of HA client.
- The data of the connected HA client are listed, and each client can be enabled or disabled.

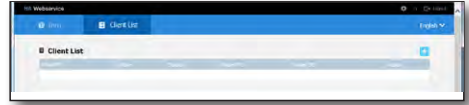

HA Client Details

The setting of HA client in Web is the same as the above setting.

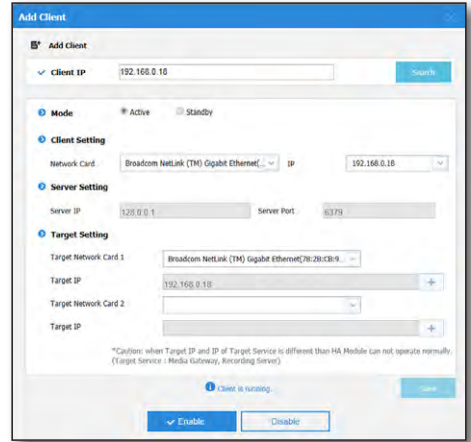

HA Status Checking (Tray Icon)

Server Status

Status	Server Icon	Description
Disable(default)		The HA server is not used.
Enable		The HA server is operating.

HA Client Status

Status	HA Client Icon	Description
Disable(default)		The HA function is not used. It can be set to use the HA function. Error status.
Primary(Active)		State in which HA is in operation with the HA Primary(Active) client logged in
Secondary(Standby)		State in which HA is in operation with the HA Secondary(Standby) client logged in
FakeActive		State in which HA Secondary(Standby) client substitutes for HA Primary(Active) client that is out of order

Dashboard

BEFORE INSTALLATION

What is dashboard?

This manual is a user guide for the dashboard website that provides Web service without the need for installation of additional product(s). Through this system, you can check and manage the entire SSM system status. You can access the dashboard using a browser on a PC that can access the web. It provides the system's On/Off status, equipment information, period-based trend analysis, and event-related information to allow you to make quick and accurate responses according to the equipment's state.

Equipment requirements

Model	Remarks
SSM v1.6	Enterprise license
SSM_RS v1.6	
NVR	SNMP supported models (e.g. SRN-4000)

Web browser requirements

To use the dashboard, one of the following browsers is required in order to meet the specified requirements:

- Internet Explorer 11
- Chrome 54
- FireFox 49
- Opera 41
- Safari 5.1.7

Dashboard

GETTING STARTED

Checking Licenses

1. Run the license manager.
2. On the Software license tab, check whether the SSM Enterprise License is activated.

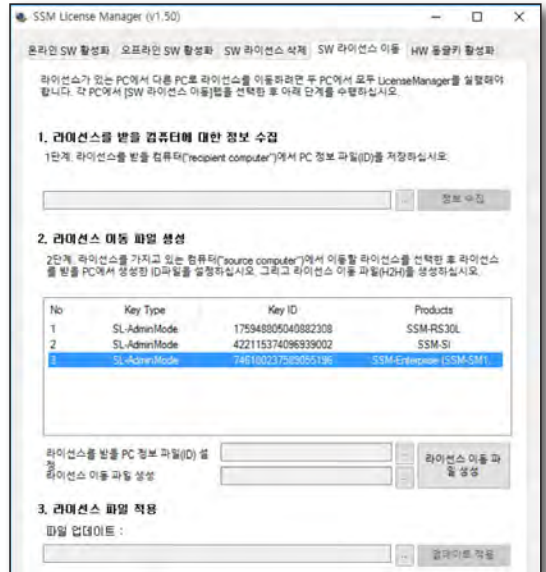

Checking Service

1. Although the Redis service runs automatically, assess whether it is operating normally.



Checking Access

1. Run the Internet browser and enter a URL.
 - `http://{SM IPAddress}:9999/dashboard/index.html`
2. If the login screen appears normally, you can log in and use the program.

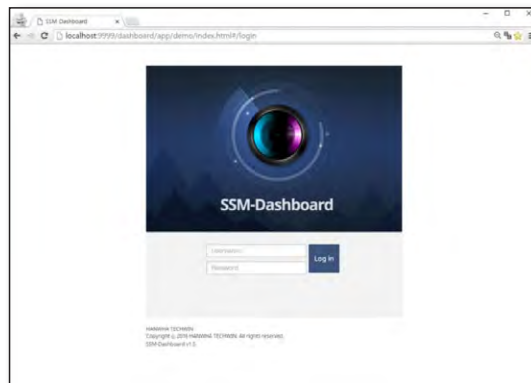

Dashboard

DASHBOARD

Login

1. Access the following URL: `http://{SM IPAddress}:9999/dashboard/index.html`
2. Enter the ID and password of your SSM account and press the login button.

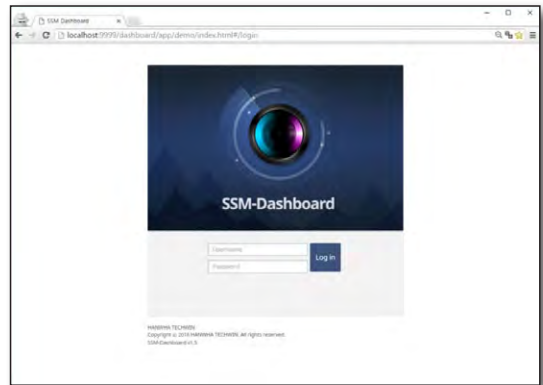

Log out

1. Click the Logout button at the top right of the screen.

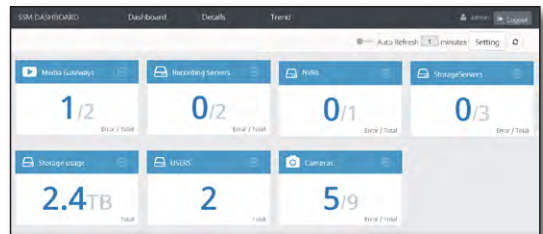

DASHBOARD

Summarized information about the entire system is provided on the single Dashboard page. This allows you to check the status of equipment at a glance.

Equipment status indication

1. Based on the type of equipment used, the number of devices generating an error over the total number of devices is displayed.
2. If you click the arrow icon () on the equipment status box, you will be redirected to the detailed equipment information page.
3. If you click on the number of devices that show equipment errors, you will be redirected to the detailed information page for that particular equipment.
 - Camera: Moves to the Site page under Details.
 - Media Gateway: Moves to the Media Gateway Classification page under Details.
 - Recording Server: Moves to the Recording Server Classification page under Details.
 - NVR: Moves to the NVR Classification page under Details.
 - StorageServers : Moves to the system classification page for recordingservers of Details.
 - Stroage usage : Moves to the system classification page for recordingservers of Details.
 - Users : Moves to the system details page for SystemManager of Details.

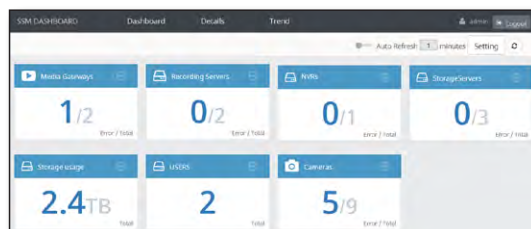

Setting Auto Refresh

You can update the equipment status information at a designated interval.

1. Click the <Auto Refresh> button at the top right of the screen
2. Set the Refresh interval.
 - Interval needs to be entered as an integer.
3. The equipment status information will be updated at the designated time interval.

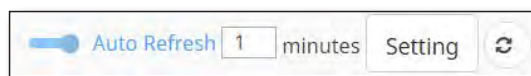

Dashboard

Refresh

You can manually update the equipment status information.

1. Click the Refresh button () at the top right of the screen.
2. The equipment information will be updated.

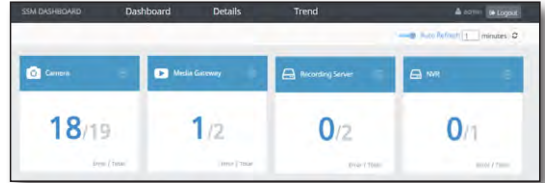

Setting

Possible to set the display information of Dashboard page.

1. Click the Setting button () at the upper right.
2. Configure the items to display on the page by selecting check boxes of the List.
3. This is displayed in the manner configured by the user.

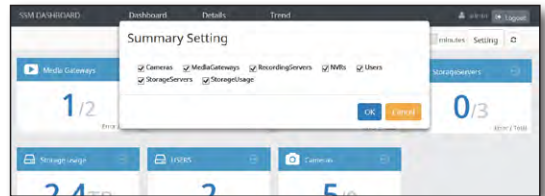

DETAIL

A status information and detailed information page is provided for each piece of equipment, and you can check the information of a specific camera assigned to the site.

Checking the system's equipment connection status

1. The equipment is classified into each unit and displayed on a server tree.
2. The number of connected devices is displayed for each piece of equipment.
3. Equipment status information is displayed using icons.
4. When you click on the equipment classification, you can see the equipment summary information.
5. When you click on the name of the specific equipment, you will be redirected to the detailed information screen.



Checking System Manager Status Information

1. Click System Manager on the server tree.
2. Under System Manager, check the CPU, memory, and network status.
3. By using the View More button on the summary information page, you can move to the detailed information page.

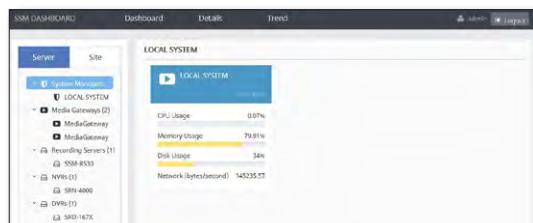

Dashboard

Checking Detailed System Manager Information

1. Click LocalSystem in the server tree, or click the View More button in System Managers window.
2. You can check information on Users who access the system.
 - User information can be checked by ID, IP address, and service.
3. You can check the temporal progress of status information on CPU, Memory, and Network.
 - Graphs can be checked on the basis of Today, Week, Month, and 3 Months.



Checking Media Gateway Status Information

1. Click Media Gateway on the server tree.
2. Check the CPU, memory, and network status of the MG server.
3. By using the View More button on the Summary Information page, you can then move to the Detailed Information page.
4. If you click on All/Error Filter, you will be able to view the information of any equipment in an error state.
5. When you move pages using the arrow icon on the Dashboard page, the error filter is applied and displayed.

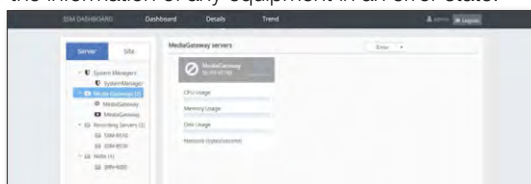
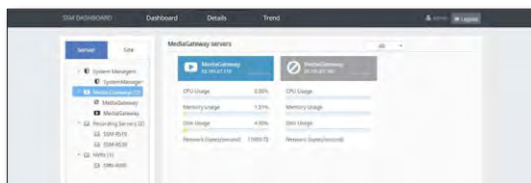

Checking Detailed Media Gateway Information

1. On the server tree, click on either the Media Gateway or View More buttons on the Media Gateway screen.
2. Check the IP/Port/Connection of the MG server.
3. You can also check the period-specific trends of the CPU, memory, and network status information.
 - You can set the graph intervals as day, week, past month, or past 3 months.



Dashboard

Checking Recording Servers Status Information

1. Click Recording Servers on the server tree.
2. Check the CPU, memory, and network status of the RS server.
3. Using the View More button on the Summary Information page, you can move to the Detailed Information screen.
4. You can then check the status of a camera connected to the RS server.
 - When you select the [>] button next to the camera information, you can view the status information for each camera.
5. You can assess the capacity and use information of the RS server disk.
 - When you select the [>] button next to the camera information, you can classify information according to the camera's status.
6. If you click on the All/Error Filter, you will be able to view the information of any equipment in an error state.
7. When you move between pages using the arrow icon on the Dashboard page, the error filter is applied and displayed.

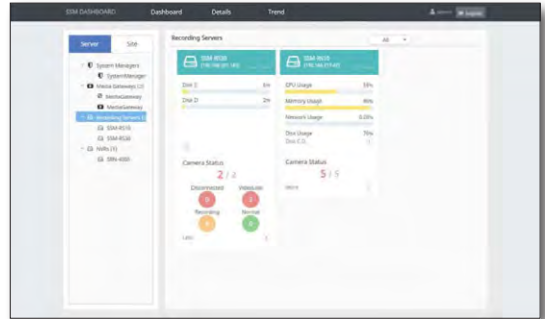

Checking Detailed Recording Servers Information

1. On the server tree, select the name of the Recording Server or click on the View More button on the Recording Servers screen.
2. Check the IP/Port/Connection of the RS server.
3. You can also check the period-specific trends associated with the CPU, memory, and network status information.
4. You can set the graph interval as day, week, past month, or past 3 months.
5. You can check the capacity and use information for each disk.
6. You can check the status information of a camera connected to the RS server.
 - You can classify the information according to the camera's status.



Checking NVRs Status Information

1. Click NVRs on the server tree.
2. Using the View More button on the Summary Information page, you can move to the Detailed Information screen.
3. Check the status information of a camera connected to the NVRs.
4. You can check the capacity and use information for the NVR server disk.
5. If you click on All/Error Filter, you will be able to view the information of any equipment in an error state.
6. When you move between pages using the arrow icon on the Dashboard page, the error filter will be applied and displayed.
7. If the SNMP of the connected NVR is turned off or is not supported, a "Not Support" message is displayed.

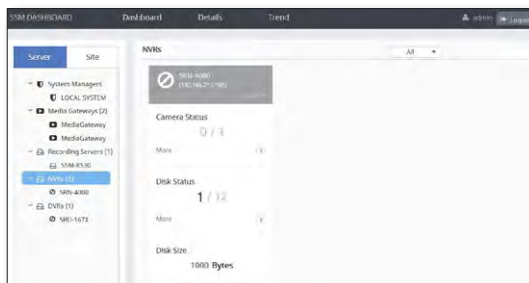
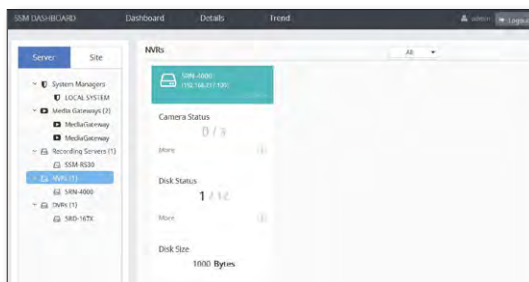

Checking NVR Status Information

1. Click on the name of the NVR on the server tree or click on the View More button on the screen.
2. Check the IP/Port/Connection of the NVR server.
3. You can verify the capacity and status information of each disk.
4. You can check the status information of a camera connected to the NVR server.
 - You can classify the information according to the camera's status.

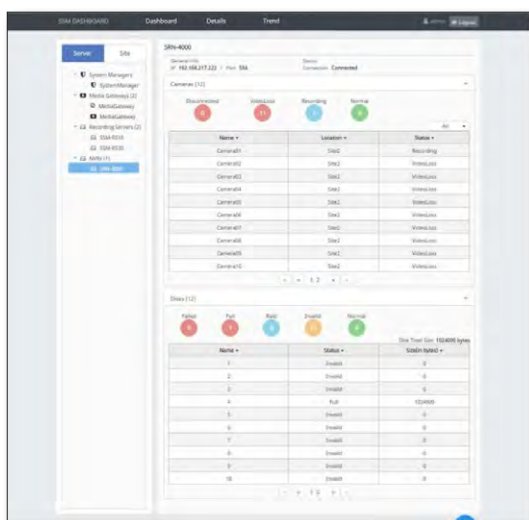

Dashboard

Checking Camera Status Information

1. Click the name of a site on the site tree.
2. The status information of the camera assigned to the selected site is displayed.
3. When you click on the name of the superordinate site, the information of camera(s) assigned to the subordinate site(s) is also displayed.
4. You can classify the information according to the camera's status.

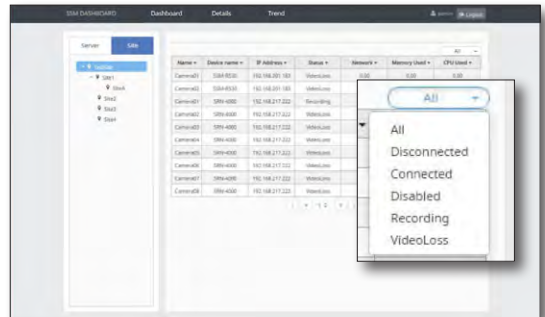

TREND

You can search for and retrieve any event generated from the system.

Searching Events

1. Move to the TREND page.
2. Configure the "Set Only Location" option. The event type will change according to the option settings.
 - Set Only Location ON : event type that contains the location information
 - Set Only Location OFF : event type that does not contain the location information
3. If the "Set Only Location" option is turned ON, select the site at which you are going to search for an event.
 - If the "Set Only Location" option is turned OFF, the site selection section will be disabled.
4. Select an event type to search.

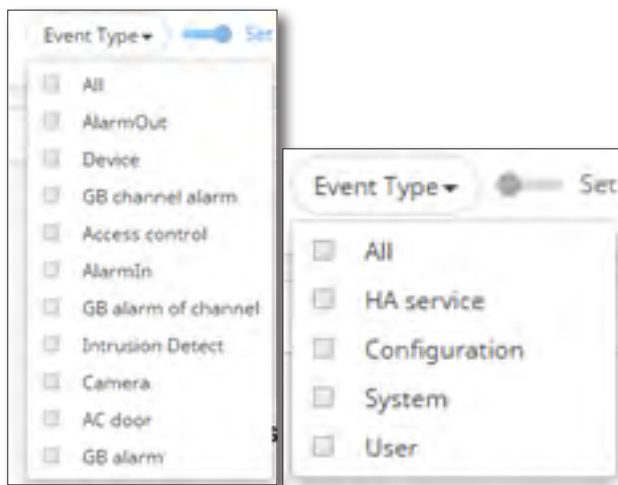

5. Designate a search period.
 - Button settings: By clicking the button, you can specify a given search period based on the search date.
 - Period selection settings: When you select the calendar icon, you can specify the search date.

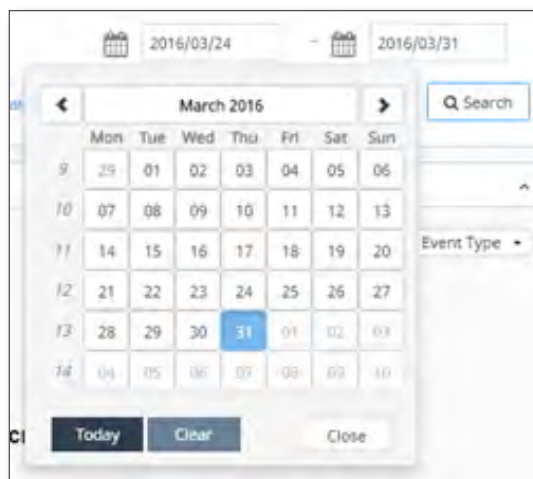

6. Click the <Search> button.

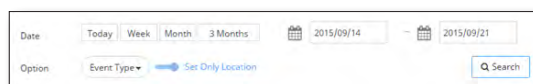

Dashboard

Checking Trend

1. When searching specific data, the number of occurrences per date is displayed in graph form.
2. When searching an event that contains location information, you can draw a graph by event type or location.
 - If the "Set Only Location" option is turned OFF, you can only draw a graph by event type.
3. When you scroll your mouse over the graph, you can see the number of applicable events.

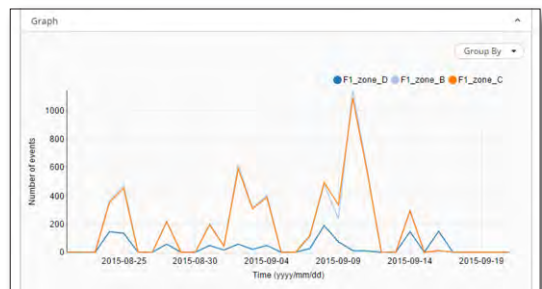
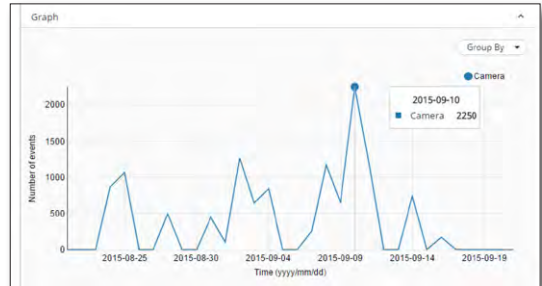

Checking Event Details

1. You can examine information such as event type and occurrence time.
2. If the search results exceed 10, you can move to the next page of search results using the page control at the bottom of the screen.
3. When you select a specific page, you will be able to view the events on that selected page.

Source	Occured Date Time(D-M-Y H:M:S)	Type	Status	Location	Severity
Camera04[192...	2015-09-21 15:45:55 KST	IV Passing	New	F1_zone_C	Medium
Camera01[192...	2015-09-21 15:45:55 KST	IV Passing	New	F1_zone_B	Medium
Camera04[192...	2015-09-21 15:44:41 KST	IV Passing	New	F1_zone_C	Medium
Camera01[192...	2015-09-21 15:44:41 KST	IV Passing	New	F1_zone_B	Medium
Camera04[192...	2015-09-21 15:07:10 KST	Camera conn...	Log	F1_zone_C	Medium
SNP-5300H[19...	2015-09-21 15:06:40 KST	Device connect...	Log	.	Medium
SNP-5300H[19...	2015-09-21 14:56:26 KST	Device disconn...	New	.	Medium
Camera04[192...	2015-09-21 14:42:54 KST	IV Passing	New	F1_zone_C	Medium
Camera01[192...	2015-09-21 14:42:54 KST	IV Passing	New	F1_zone_B	Medium

How to store Events

You can store the information table of searched events in PDF files.

1. Store the event table of the currently selected page.
2. Click the menu of PDF store from Event table menu.
3. When 'Store' is selected, the "ssm_dashboard_EvnetList.pdf" file is stored in the path of "My Computer > Download".

appendix

PRODUCT SPECIFICATION

Features		
Video	Supported Video Compression Format	H.264, MPEG-4, MJPEG
	Supported resolution	Depending on the device
Audio	Supported Audio Compression Format	G.711 μ -law (PCM), G.723, G.726 (ADPCM), AAC codec
	Functions	Bi-directional audio (Listen/Talk)
Live Monitoring	Multi-monitor	Up to 4 monitors (Follow the recommended system requirement)
	Screen-split mode	4:3 screen modes : 1/4/6/8/9/10/13/16/17/21/25/36/49/64 16:9 screen modes : 6/12/20/30 Full screen mode * While in multi-monitor environment, layouts and split modes for less than 100 channels will be available.
	Sequence mode	up to 16-splits per monitor
	PTZ Control	Area Zoom, Go to 1x zoom, PTZ Sensitivity, Focus, Zoom, Patrol, Swing/Autopan, Group/Scan, Trace/Pattern, Preset, Iris control
	Map monitoring	Split View Mode for Map Layout, Zoom in/out, video popup(Instant viewer), Camera/Sensor/Alarm Out icons on the map
	Simple Recording	Recording of the selected video tile during 1hour
	Functions	OSD On/Off, Snapshot / Prints Image, Brightness/Contrast control, Keep Aspect Ratio/Original size, Deinterlacing, Flip, Digital zoom
Search & Playback	Search mode	Date, Event, Smart Search, POS Search based on DVR, NVR, Local folder
	Screen-split mode	Up to 16 footages can be played simultaneously
	Video Control	Start/stop, Pause, Faster/Slower forward/backward, Step Forward/Backward, Skip Forward/Backward
	Functions	Snapshot / Prints Image, Digital zoom
	Backup	Local storage, back up format(AVI, SEC) Configurable schedule for backup (*supported model only)

appendix

Features		
Event Monitoring	Real-time event list	Shows real-time event list of the device(event status, type, device, user, time(PC)), Viewing instant video image
	Searching events	<ul style="list-style-type: none"> - SSM : User, System - Device : System, Camera, Sensor, Alarm Out - Camera : Video Loss, Motion, Passing, Entering, Exiting, Disappearing (Appearing), Tampering, Tracking, Face Detection, Audio Detection
	Reporting	Manual report (show events and statistics) print & Save function, format(excel, PDF, word)
	Confirming	set alarm details Normal/Abnormal/Etc, confirm action
	History	the confirmed details of the selected event from the list
	Instant Viewer	Display the selecting camera. Confirm the event, record event remarks and end the event status.
	Instant Player	Plays the corresponding camera's video image
	Event Action	Define various system actions (output) for events (input) from devices, action (output) types: Instant Viewer, Preset, Alarm Out, Pop-up, Sound and E-mail notification
Configuration		
Site/User management		Site/User group/User account management, Permission management for viewer functions
Device management		Automatic device IP scanning, Viewing the device settings(Device webpage), Exporting/Importing devices settings, Updating the device firmware
Screen management	Layouts	Setting/Adding/Deleting Layouts, Map/Video Layout
	Monitor	Multi Monitor, Split Screen, Sequence, Using I-Frame, Using low-resolution
Environment		OSD display, Date/Time, Capture, Recording, Sartup, Language, UI auto lock, Log
System settings		Backup/Restore SSM setups, Restore the devault settings
Time synchronization		NTP Server, Client
Update		Automatic self upgrade(Connection to Hanwha Techwin upgrade server)
Supported devices		Hanwha Techwin's N/W Camera, Encoder, DVR/NVR
Maximum number of Media Gateways per system		Default 4 Media Gateway
Maximum number of Free NET-i ware/Recording Server per system		1 NET-i ware/Recording Server

Configuration	
Maximum number of cameras per Media Gateway	N/W Camera 72channels or DVR/NVR 288channels(36)
Maximum number of clients per Media Gateway	5 Clients
Modules	System Manager, Media Gateway, Console, Service Manager, Configuration Manager
Language	Total 23 languages support English, French, German, Spanish, Italian, Russian, Chinese, Japanese, Korean, Turkish, Polish, Czech, Serbian, Romanian, Portuguese, Dutch, Croatian, Hungarian, Greek, Swedish, Danish, Finnish, Norwegian, Bulgarian
System Requirement	Recommended <ul style="list-style-type: none"> - System manger, media gateway and console : CPU Intel Core i7-4770 @ 3.40GHz, RAM 8GB or more, Video Memory 1024MB or more (Geforce GTX760 GPU), 20GB or more available space in HDD (10GB or more available space to save the log DB for operation after installation), GTX960 or higher for CUDA decoder usage, and Driver version 368.69 or higher for CUDA decoder usage - Recording Server : CPU Intel Core i7-4770 @ 3.40GHz, RAM 16GB, SSD (for OS disk), 4 or more HDD SATA 7200rpm 64MB (for recording disk) * RAID specification : RAID5, 8Bay, HW RAID controller (AF support) * iSCSI specification : Including RAID specification above, NIC bandwidth 2G or higher, 2 or more NIC's (NIC Teaming)
	Minimum <ul style="list-style-type: none"> - System manger, media gateway and console : CPU Intel Core i5-4670 @ 3.40GHz, RAM 4GB or more, Video Memory 512MB or more (Geforce GT240), 20GB or more available space in HDD (10GB or more available space to save the log DB for operation after installation) - Recording Server : CPU Intel Core i5-4670 @ 3.40GHz, RAM 8GB, 2 or more HDD SATA2 7200rpm 64MB (1 OS disk and 1 or more recording disks) * RAID specification : RAID5, 8Bay, HW RAID controller (AF support), Windows Server 2012 64bit * iSCSI specification : Including RAID specification above, NIC bandwidth 2G or higher, 2 or more NIC's (NIC Teaming)
	Operating System <ul style="list-style-type: none"> - Console : Windows7 32bit/64bit, Windows8 32bit/64bit or Windows8.1 32bit/64bit, Windows 10 32bit/64bit - Media gateway : Windows7 32bit/64bit, Windows8, 32bit/64bit, Windows8.1 32bit/64bit, Windows Server 2008 R2 64bit, Windows Server 2012 32bit/64bit, Windows 10 32bit/64bit - System manager : Windows Server 2008 64bit, Windows Server 2012 64bit, Windows Server 2012 R2 64bit - Recording Server Recommended Specifications : Windows Server 2008 R2 64bit, Windows Server 2012 R2 64bit, Windows 10 32bit/64bit Minimum Requirements : Windows Server 2008 R2, Windows Server 2012 R2, Windows 7, Windows 8, Windows 8.1, Windows 10 32bit/64bit

LIST OF PORTS USED IN SSM

Name	Port	Protocol
System manager	9999, 61616	TCP for Web Service (9999), Active MQ (61616)
Media Gateway	4510, 4511, 4512, 4513	TCP (4510, 4511) HTTP(CGI) for Mobile (4512) RTSP for Mobile (4513)

USE JOYSTICK

You can check the connection settings and connection status in "**SSM CONSOLE Settings > Environment > System Controller**".

SPC-2000

The SPC-2000 joystick is operated as follows:

- SPC-2000 must be connected to the PC before the console is launched in order to be recognized.
- SPC-2000 can run in PTZ or Screen mode.
- In Screen mode, the layouts assigned to the console are numbered 1~8 in the order of assignment.

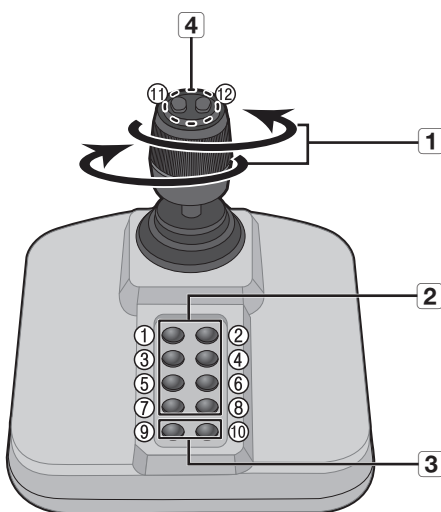

	Name	Function
1	Up/Down/Left/Right	In PTZ mode, the camera can be panned, tilted, and controlled in 8 directions. In Screen mode, the top/bottom/left/right tile can be selected.
	Rotation	In PTZ mode, the screen is zoomed in when it is rotated clockwise and zoomed out when it is rotated counterclockwise.
2	1 ~ 8	In PTZ mode, presets number 1~9 are run. In Screen mode, the layout corresponding to the button number is run.
3	9~10	PTZ mode and Screen mode are switched.
4	11, 12	In PTZ mode, Focus Near/Far operation is run. In Screen mode, multiple monitors can be selected and changed.



- To set the correct image, the axis calibration is needed.

Select **[Start]** → **[Set]** → **[Control Panel]** → **[Game Controller]** → **[Property]** → **[Set]** via the PC, click the **[Compensation]** button to run the "**System Compensation Wizard**" and then follow the guide on the screen to complete axis compensation.

SPC-7000

The operating specifications with SPC-7000 joystick connected are as follows.

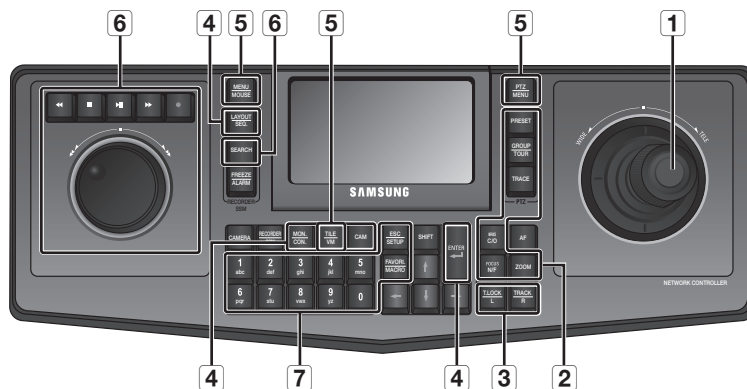

- SPC-7000 displays each operating status of the system controller on the LCD monitor, and allows the user to easily select a menu with a touch screen, or using a joystick.
- It operates in the following 5 modes; PTZ/Screen/Mouse/Console/VM



Name		Function
1	Joystick	Up/Down/Left/Right In PTZ mode, you can control the Pan and Tilt motion. In Screen mode, you can change the Up/Down/Left/Right tile selection. In Mouse mode, you can move the mouse cursor.
		Rotation In PTZ mode, the screen zooms in when turning in the WIDE direction, and zooms out when turning in the TELE direction.
2	PTZ control	[FOCUS N/F] + [←] Runs the Focus Near/Far motion. - [FOCUS N/F] + [←] : Focus Near
		[FOCUS N/F] + [→] - [FOCUS N/F] + [→] : Focus Far
		[IRIS C/O] + [→] Runs the IRIS Open/Close operation. - [IRIS C/O] + [→] : IRIS Open
		[IRIS C/O] + [←] - [IRIS C/O] + [←] : IRIS Close
		[PRESET] When you click a number + [PRESET] button, the preset corresponding to each button number is activated.
		[GROUP] When you click a number + [GROUP] button, Group/Scan corresponding to each button number is activated.
		[TRACE] When you click a number + [TRACE] button, Pattern/Trace corresponding to each button number is activated.
		[ZOOM] + [→] Runs the zoom in motion.
		[ZOOM] + [←] Runs the zoom out motion.

appendix

	Name	Function
3	Mouse control	[T. LOCK(L)]/ [TRACK(R)] Uses the left/right button of the mouse in mouse mode.
4	Screen control	[MON.(CON.)] You can change the multi monitor selection by clicking a number + [MON. (CON.)] button in the screen mode (previous/next according to the monitor number).
		[LAYOUT(SEQ.)] When you click a number + [LAYOUT (SEQ.)] button, the layout corresponding to each button number is activated.
		[CAM] When you click a number + [CAM] button, the camera corresponding to each button number is activated.
		[ENTER] Clicking once will display a single screen on the live viewer. Clicking once again will return to the original screen. When you click a number + [ENTER] button in the live viewer, the screen is split into the number input.
		LCD SnapShot Button Captures the video of the current tile.
		LCD UI Alarm Off Button Initializes the event.
		number + [TILE(VM)] Moves to the tile corresponding to the number.
5	Mode Change	[PTZ(MENU)] Changes the PTZ mode. Click the [PTZ (MENU)] button while in PTZ mode and the screen mode will be changed.
		[SHIFT] + [MENU(Mouse)] Changes the mouse mode. Click the [SHIFT] + [MENU (Mouse)] buttons while in mouse mode and the screen mode will be switched.
		[SHIFT] + [Mon.(Con.)] Changes the console mode.
		[SHIFT] + [TILE(VM)] Runs the VMD control.

Name		Function
6	[SEARCH]	Outputs the video of the current tile through live/search.
		The video will be stopped.
		Plays and pauses the video.
		Starts/Ends manual recording of the video.
	Shuttle wheel	Fast plays in the forward direction when the wheel is turned clockwise, or fast plays in the reverse direction when the wheel is turned counter-clockwise.
	Jog wheel	Performs frame search.
7	0 ~ 9	Button to input a number.
	[ESC(SETUP)]	Initializes the input number.
	[FAVORI.(MACRO)]	Performs the motion as a key value designated to SPC-7000 is automatically generated. Example) When the [FAVORI.(MACRO)] key is pressed, the same motion that is activated when the user presses a number + [MONITOR] + number + [TILE (VM)] is carried out.

appendix

AXIS-T8310

The operating specifications with AXIS-T8310 joystick connected are as follows.

- AXIS-T8310 video monitoring control board is a modular system comprised of 3 independent components (joystick, keypad and jog dial).
- With the AXIS-T8311 video monitoring joystick, you can control all the AXIS PTZs and PTZ dome network cameras quickly and accurately.
- With the AXIS-T8312 video monitoring keypad, you can search the working environment, camera, monitoring video and PTZ presets quickly.
- AXIS-T8313 video monitoring jog dial is used to search a recorded video.
- AXIS-T8310 operates in the following 5 modes; PTZ/Screen/Mouse/Console/VM

AXIS-T8311

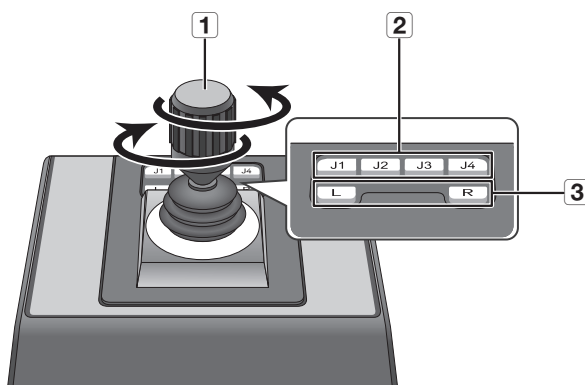



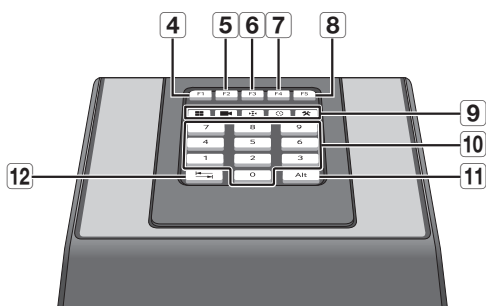

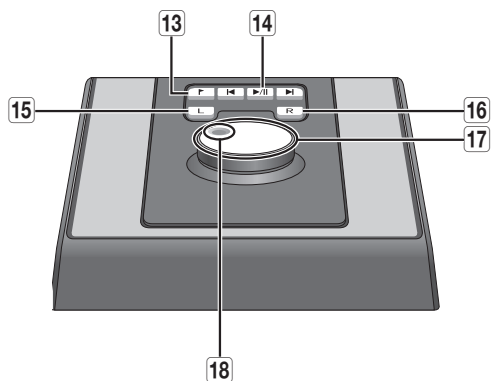









AXIS-T8312





Model	Item		Description
AXIS-T8311	1	Up/Down/Left/Right	In PTZ mode, you can control the Pan and Tilt motion. In Screen mode, you can change the Up/Down/Left/Right tile selection. In Mouse mode, you can move the mouse cursor.
		Rotation	In PTZ mode, the screen zooms in when turning in the clockwise direction, and zooms out when turning in the counter-clockwise direction.
	2	J1 ~ J4	In PTZ mode, it operates the presets configured from 1 through 4.
	3	L / R	In PTZ mode, it operates the Focus Near/Far motion (L: Near / R: Far) In Screen mode, you can change the multiple monitor selection (L: monitor number down / R: monitor number up)
AXIS-T8312	4	F1	Switches to PTZ mode.
	5	F2	Switches to Screen mode.
	6	F3	Switches to Mouse mode.
	7	F4	Runs/Exits the VM controller.
	8	F5	Initializes the event.

appendix

Model	Item	Description
AXIS-T8312		When you click the number+[] button, the layout corresponding to each button number is activated.
		When you click the number+[] button, the camera corresponding to each button number is activated.
	9 	When you click the number+[] button, the preset corresponding to each button number is activated.
		Input the time (in the hhmm format) and click the [] button to output the video footage at the designated time. e.g.) 2000+[] : Video recorded at 20:00 is output.
		When you click a number+[] button in the live viewer, the screen is split into the number input.
	10 0 ~ 9	Button to input a number.
	11 Alt	-
12 	Displays a split screen in a live viewer.	
AXIS-T8313	13 	Runs the selected bookmark.
	14 	Plays and pauses the video.
	15 L	Captures the video of the current tile.
	16 R	Outputs the video of current tile through live/search.
	17 Shuttle wheel	Fast plays in the forward direction when turning the wheel clockwise, or fast plays in the reverse direction when turning the wheel counter-clockwise.
	18 Jog wheel	Performs frame search.

OPEN SOURCE LICENSE NOTIFICATION ON THE PRODUCT

The software included in this product contains copyrighted software that is licensed under the BSD 2.0/MIT License/Apache License 1.1/Apache License 2.0/EPL 1.0/CDDL 1.1/Code Project Open 1.02 License/LGPL2.1/LGPL3.0/OpenSSL License/XFree86 License 1.0/Intel Software Development Products License/Microsoft Public License(Ms-PL)/BSD 3-clause License/Oracle Binary Code JRE and JDK 7 License/BSD 2-clause License/Creative Commons Attribution 2.0 UK License/Sun Java Message Service 1.0.2 License.

You may obtain the complete Corresponding Source code from us for a period of three years after our last shipment of this product by sending email to help.ctcv@hanwha.com

- **BSD 2.0** : Cygwin - flex, WEBM
- **MIT License** : dotNetInstaller: setup bootstrapper for Windows, Rapidxml-1.13, MicroPlanet Gravity, Newtonsoft.Json, WPF Composites, jQuery UI, jquery-i18n-properties, Newtonsoft.Json, cellcloud, gsoapwinhttp, jQuery JavaScript Library, AngularJS, datejs-rails, django-frontend-skeleton, farserver, flashcanvas, flot, Flotr2, Font-Awesome, gibberish-aes, jasmine.js, javascriptRRD, jGenUI, jQuery JavaScript Library, jQuery UI - jquery/jquery-ui on GitHub, jqueryui.com, magixcms, moment, ng-grid, require-expose-plugin
- Apache License 1.1 : Apache Jakarta Commons Collections
- **Apache License 2.0** : Apache.NMS, Apache.NMS.ActiveMQ, MassTransit, spring-net, AAL-WPF-ServiceStack, Apache-Logging log4net, Quartz Enterprise Scheduler .NET, Apache Jakarta Commons IO, Apache Jakarta Lang, Apache Shiro, Apache-Jakarta BeanUtils, Apache-Jakarta Collections, Apache-Jakarta Pool, Condor, EZMorph, Jakarta Commons-Logging, json-lib, jackson-databind, ActiveMQ :: Assembly, ActiveMQ :: KahaDB, angularjs-nvd3-directives, Apache Commons JavafLOW, Apache Commons Lang, Apache Directory Studio, Apache Felix Configuration Admin Service, Apache Felix File Install, Apache Felix Remote Shell, Apache Felix Shell Service, Apache Felix Web Management Console, Apache Geronimo, Apache ServiceMix :: Bundles :: antlr-runtime, Apache ServiceMix :: Bundles :: cglib, Apache ServiceMix :: Bundles :: commons-lang, Apache ServiceMix :: Bundles :: mybatis, Apache ServiceMix :: Bundles :: quartz, Apache ServiceMix Transaction, Apache-Jakarta Digester, bamboo BSC, Bootstrap, Data Mapper for Jackson, Eclipse Gemini Blueprint, GetAggregatedSubjectOfCareSchedule, Groovy, J2EE Management 1.1, Jackson, Jackson - org.codehaus.jackson:jackson-core-asl, jedis, jettison, kairostdb, m2engine, mobile-system, mybatis, osgiwiki, restlet-framework-java, sigar, tomcat-jdbc, Umbraco-CMS, JmDNS, WSO2 Governance Registry
- **EPL 1.0** : Eclipse Project, Eclipse Equinox, org.eclipse.osgi, osgi-vaadin-demo, groovy-eclipse, rhf-competitions
- **CDDL 1.1** : GlassFish, JSR-311 - JAX-RS - The Java API for RESTful Web Services (Jersey), jersey-bundle, browser-detect
- **Code Project Open 1.02 License** : Code Project - AlphaBlendTextBox - A transparent/translucent textbox for .NET, Code Project - Animating Windows Forms, Code Project - BarTender - Group your contents, Code Project - Cabinet File (*.CAB) Compression and Extraction, Code Project - Data Encryption/Decryption using RijndaelManaged and PasswordDeriveByt, Code Project - How to skin scrollbars for Panels, in C#, Code Project - Simple Movie Database in C# using Microsoft Access, Code Project - Windows Management Instrumentation (WMI) Implementation, Code Project - WPF TreeListView Control, Code Project - Creating an XML file based on XSD, Code Project - A reusable, high performance, socket server class - Part 1, Code Project - Install Windows Service using Custom Action
- **LGPL 2.1** : Live555, javastruct, JFreeChart - 1. JFreeChart, JFreeChart - 3. Jcommon, jna, FFMPEG
- **LGPL 3.0** : JasperReports Library - jasperreports, m-surveys
- **OpenSSL License** : OpenSSL 1.0.1g
- **XFree86 License v 1.0** : XFree86
- **Intel Software Development Products License** : Intel Integrated Performance Primitives - Intel IPP
- **Microsoft Public License(Ms-PL)** : cfx, netsqlzaman, mooncodecs, Extended WPF Toolkit, Altairis Web UI Toolkit, NumericalDataApplication, WPF Wizard Control, Latence, EasyTweet
- **BSD 3-clause License** : Open Computer Vision Library - opencv-win, ASM Core, d3, DataTables, DataTablesSrc, jQuery::DataTables, MvcDataTables.NET, Paul Johnson's JavaScript Message Digest Hash Function Library
- **Oracle Binary Code JRE and JDK 7 License** : Java Cryptography Extension (JCE) Unlimited Strength Jurisdiction Policy
- **BSD 2-clause License** : morris.js, Leaflet
- **Creative Commons Attribution 2.0 UK License** : Webtoolkit Javascript base64
- **Sun Java Message Service 1.0.2 License** : Java Message Service (JMS)

BSD 2.0

Copyright (c) 1990, The Regents of the University of California.

All rights reserved.

Redistribution and use in source and binary forms, with or without modification, are permitted provided that the following conditions are met:

- Redistributions of source code must retain the above copyright notice, this list of conditions and the following disclaimer.
- Redistributions in binary form must reproduce the above copyright notice, this list of conditions and the following disclaimer in the documentation and/or other materials provided with the distribution.
- Neither the name of Google Inc. nor the names of its contributors may be used to endorse or promote products derived from this software without specific prior written permission.

THIS SOFTWARE IS PROVIDED BY THE COPYRIGHT HOLDERS AND CONTRIBUTORS "AS IS" AND ANY EXPRESS OR IMPLIED WARRANTIES, INCLUDING, BUT NOT LIMITED TO, THE IMPLIED WARRANTIES OF MERCHANTABILITY AND FITNESS FOR A PARTICULAR PURPOSE ARE DISCLAIMED. IN NO EVENT SHALL THE COPYRIGHT OWNER OR CONTRIBUTORS BE LIABLE FOR ANY DIRECT, INDIRECT, INCIDENTAL, SPECIAL, EXEMPLARY, OR CONSEQUENTIAL DAMAGES (INCLUDING, BUT NOT LIMITED TO, PROCUREMENT OF SUBSTITUTE GOODS OR SERVICES; LOSS OF USE, DATA, OR PROFITS; OR BUSINESS INTERRUPTION) HOWEVER CAUSED AND ON ANY THEORY OF LIABILITY, WHETHER IN CONTRACT, STRICT LIABILITY, OR TORT (INCLUDING NEGLIGENCE OR OTHERWISE) ARISING IN ANY WAY OUT OF THE USE OF THIS SOFTWARE, EVEN IF ADVISED OF THE POSSIBILITY OF SUCH DAMAGE.

MIT License

Copyright (c)

- dotNetInstaller: setup bootstrapper for Windows (2009, Davide Icardi, Vestris Inc. and Contributors)
- Rapidxml-1.13 (2006-2009, Marcin Kalicinski)
- Newtonsoft.Json (2007, James Newton-King)
- AngularJS (2010-2012 Google, Inc. <http://angularjs.org>)
- crypto-js (2009-2013, by Jeff Mott. All rights reserved. code.google.com/p/crypto-js/wiki/License)
- datejs-rails (2006-2007, Coolite Inc. (<http://www.coolite.com/>). All rights reserved.)
- django-frontend-skeleton (2005, 2013 jQuery Foundation, Inc. jquery.org/license)
- farserver (2012 AUTHORS.txt; Licensed MIT, GPL)
- flashcanvas (2009, Tim Cameron Ryan / 2009-2011, FlashCanvas Project)
- flot (2007, IOLA)
- Flotr2 (2011, Jacob Thornton)
- Font-Awesome (Dave Gandy)
- gibberish-aes (2008, Mark Percival - <http://mpercival.com>)
- jasmine.js (2008-2014 Pivotal Labs)
- javascriptRRD (2012, Krzysztof Urbas @krzysu [myviews.pl])
- jGenUI (2008 Paul Bakaus (ui.jquery.com))
- cellcloud (2009-2012, Cell Cloud Team - cellcloudproject@gmail.com)
- gsoapwinhttp (2011, Daniel Rozsar)

- jQuery v1.10.2 (2005, 2013 jQuery Foundation, Inc. | jquery.org/license)
- jQuery v1.7.1 (jquery.com | jquery.org/license)
- jQuery JavaScript Library v2.0.3 (2005, 2013 jQuery Foundation, Inc. and other contributors)
- jQuery UI (2013 jQuery Foundation)
- jQuery JavaScript Library v1.9.1 (2005, 2012 jQuery Foundation, Inc)
- magixcms (HTML5 Shiv v3.7.0 | @afarkas | @jon_neal | @rem)
- ng-grid (2012 the AngularUI Team, <http://angular-ui.github.com>)
- RequireJS (2010-2012, The Dojo Foundation All Rights Reserved)

Permission is hereby granted, free of charge, to any person obtaining a copy of this software and associated documentation files (the "Software"), to deal in the Software without restriction, including without limitation the rights to use, copy, modify, merge, publish, distribute, sublicense, and/or sell copies of the Software, and to permit persons to whom the Software is furnished to do so, subject to the following conditions:

The above copyright notice and this permission notice shall be included in all copies or substantial portions of the Software.

THE SOFTWARE IS PROVIDED "AS IS", WITHOUT WARRANTY OF ANY KIND, EXPRESS OR IMPLIED, INCLUDING BUT NOT LIMITED TO THE WARRANTIES OF MERCHANTABILITY, FITNESS FOR A PARTICULAR PURPOSE AND NONINFRINGEMENT. IN NO EVENT SHALL THE AUTHORS OR COPYRIGHT HOLDERS BE LIABLE FOR ANY CLAIM, DAMAGES OR OTHER LIABILITY, WHETHER IN AN ACTION OF CONTRACT, TORT OR OTHERWISE, ARISING FROM, OUT OF OR IN CONNECTION WITH THE SOFTWARE OR THE USE OR OTHER DEALINGS IN THE SOFTWARE.

The Apache Software License, Version 1.1

Copyright (c) 2000 The Apache Software Foundation. All rights reserved.

Redistribution and use in source and binary forms, with or without modification, are permitted provided that the following conditions are met:

1. Redistributions of source code must retain the above copyright notice, this list of conditions and the following disclaimer.
2. Redistributions in binary form must reproduce the above copyright notice, this list of conditions and the following disclaimer in the documentation and/or other materials provided with the distribution.
3. The end-user documentation included with the redistribution, if any, must include the following acknowledgment:

"This product includes software developed by the Apache Software Foundation (<http://www.apache.org/>)."

Alternately, this acknowledgment may appear in the software itself, if and wherever such third-party acknowledgments normally appear.

4. The names "Apache" and "Apache Software Foundation" must not be used to endorse or promote products derived from this software without prior written permission. For written permission, please contact apache@apache.org.

5. Products derived from this software may not be called "Apache", nor may "Apache" appear in their name, without prior written permission of the Apache Software Foundation.

THIS SOFTWARE IS PROVIDED "AS IS" AND ANY EXPRESSED OR IMPLIED WARRANTIES, INCLUDING, BUT NOT LIMITED TO, THE IMPLIED WARRANTIES OF MERCHANTABILITY AND FITNESS FOR A PARTICULAR PURPOSE ARE DISCLAIMED. IN NO EVENT SHALL THE APACHE SOFTWARE FOUNDATION OR ITS CONTRIBUTORS BE LIABLE FOR ANY DIRECT, INDIRECT, INCIDENTAL, SPECIAL, EXEMPLARY, OR CONSEQUENTIAL DAMAGES (INCLUDING, BUT NOT LIMITED TO, PROCUREMENT OF SUBSTITUTE GOODS OR SERVICES; LOSS OF USE, DATA, OR PROFITS; OR BUSINESS INTERRUPTION) HOWEVER CAUSED AND ON ANY THEORY OF LIABILITY, WHETHER IN CONTRACT, STRICT LIABILITY, OR TORT (INCLUDING NEGLIGENCE OR OTHERWISE) ARISING IN ANY WAY OUT OF THE USE OF THIS SOFTWARE, EVEN IF ADVISED OF THE POSSIBILITY OF SUCH DAMAGE.

This software consists of voluntary contributions made by many individuals on behalf of the Apache Software Foundation. For more information on the Apache Software Foundation, please see <http://www.apache.org/>.

Portions of this software are based upon public domain software originally written at the National Center for Supercomputing Applications, University of Illinois, Urbana-Champaign.

Apache License 2.0

We used the Apache ActiveMQ in our application and we did not modify the source code.

Copyright (c)

- Apache.NMS (2005-2006, The Apache Software Foundation)
- Apache ActiveMQ (2005-2008, The Apache Software Foundation)
- MassTransit (2007-2008, The Apache Software Foundation)
- spring-net (2002-2011, the original author or authors)
- AAL-WPF-ServiceStack ()
- Apache-Logging log4net (2004-2013, The Apache Software Foundation)
- Quartz Enterprise Scheduler .NET (2001-2013, Terracotta Inc. and Marko Lahma)
- Apache Jakarta Commons IO (2001-2014, The Apache Software Foundation)
- Apache Jakarta Lang (2001-2014, The Apache Software Foundation)
- Apache Shiro (2008-2014, The Apache Software Foundation)
- Apache-Jakarta BeanUtils (2001-2014, The Apache Software Foundation)
- Apache-Jakarta Collections (2001-2014, The Apache Software Foundation)
- Apache-Jakarta Pool (2001-2014, The Apache Software Foundation)
- Condor (2001-2014, The Apache Software Foundation)
- EZMorph (2006-2007, the original author or authors)
- Jakarta Commons-Logging (2001-2013, The Apache Software Foundation)
- json-lib (2002, JSON.org)
- jackson-databind (2012-2013, FasterXML)
- angularjs-nvd3-directives (2014, Christian Maurer; Licensed Apache License, v2.0)
- Apache Commons Javaflow (2004-2008, The Apache Software Foundation)
- Apache Commons Lang (2012, The Apache Software Foundation)
- Apache Geronimo (2003-2013, The Apache Software Foundation)
- Apache-Jakarta Digester (2001-2013, The Apache Software Foundation)
- bamboo BSC (2014, Dice)
- Bootstrap (2012, Twitter)
- Data Mapper for Jackson (2009, FasterXML, LLC)
- Eclipse Gemini Blueprint (2014, The Eclipse Foundation)
- J2EE Management 1.1 (2013, Oracle and/or its affiliates)
- jedis (2010, Jonathan Leibusky)
- jettison (2006, Envoy Solutions LLC)
- sigar (2004-2009, Doug MacEachern)
- tomcat-jdbc (1999-2014, The Apache Software Foundation)
- Umbraco-CMS (2011, Abdulla Abdurakhmanov)
- JmDNS (2002-2011, JmDNS)
- WSO2 Governance Registry (2014, WSO2)

1. Definitions.

"License" shall mean the terms and conditions for use, reproduction, and distribution as defined by Sections 1 through 9 of this document.

"Licensor" shall mean the copyright owner or entity authorized by the copyright owner that is granting the License.

"Legal Entity" shall mean the union of the acting entity and all other entities that control, are controlled by, or are under common control with that entity. For the purposes of this definition, "control" means (i) the power, direct or indirect, to cause the direction or management of such entity, whether by contract or otherwise, or (ii) ownership of fifty percent (50%) or more of the outstanding shares, or (iii) beneficial ownership of such entity.

"You" (or "Your") shall mean an individual or Legal Entity exercising permissions granted by this License.

"Source" form shall mean the preferred form for making modifications, including but not limited to software source code, documentation source, and configuration files.

"Object" form shall mean any form resulting from mechanical transformation or translation of a Source form, including but not limited to compiled object code, generated documentation, and conversions to other media types.

"Work" shall mean the work of authorship, whether in Source or Object form, made available under the License, as indicated by a copyright notice that is included in or attached to the work (an example is provided in the Appendix below).

"Derivative Works" shall mean any work, whether in Source or Object form, that is based on (or derived from) the Work and for which the editorial revisions, annotations, elaborations, or other modifications represent, as a whole, an original work of authorship. For the purposes of this License, Derivative Works shall not include works that remain separable from, or merely link (or bind by name) to the interfaces of, the Work and Derivative Works thereof.

"Contribution" shall mean any work of authorship, including the original version of the Work and any modifications or additions to that Work or Derivative Works thereof, that is intentionally submitted to Licensor for inclusion in the Work by the copyright owner or by an individual or Legal Entity authorized to submit on behalf of the copyright owner. For the purposes of this definition, "submitted" means any form of electronic, verbal, or written communication sent to the Licensor or its representatives, including but not limited to communication on electronic mailing lists, source code control systems, and issue tracking systems that are managed by, or on behalf of, the Licensor for the purpose of discussing and improving the Work, but excluding communication that is conspicuously marked or otherwise designated in writing by the copyright owner as "Not a Contribution."

"Contributor" shall mean Licensor and any individual or Legal Entity on behalf of whom a Contribution has been received by Licensor and subsequently incorporated within the Work.

2. Grant of Copyright License. Subject to the terms and conditions of this License, each Contributor hereby grants to You a perpetual, worldwide, non-exclusive, no-charge, royalty-free, irrevocable copyright license to reproduce, prepare Derivative Works of, publicly display, publicly perform, sublicense, and distribute the Work and such Derivative Works in Source or Object form.

3. Grant of Patent License. Subject to the terms and conditions of this License, each Contributor hereby grants to You a perpetual, worldwide, non-exclusive, no-charge, royalty-free, irrevocable (except as stated in this section) patent license to make, have made, use, offer to sell, sell, import, and otherwise transfer the Work, where such license applies only to those patent claims licensable by such Contributor that are necessarily infringed by their Contribution(s) alone or by combination of their Contribution(s) with the Work to which such Contribution(s) was submitted. If You institute patent litigation against any entity (including a cross-claim or counterclaim in a lawsuit) alleging that the Work or a Contribution incorporated within the Work constitutes direct or contributory patent infringement, then any patent licenses granted to You under this License for that Work shall terminate as of the date such litigation is filed.

4. Redistribution. You may reproduce and distribute copies of the Work or Derivative Works thereof in any medium, with or without modifications, and in Source or Object form, provided that you meet the following conditions:

1. You must give any other recipients of the Work or Derivative Works a copy of this License; and
2. You must cause any modified files to carry prominent notices stating that You changed the files; and
3. You must retain, in the Source form of any Derivative Works that You distribute, all copyright, patent, trademark, and attribution notices from the Source form of the Work, excluding those notices that do not pertain to any part of the Derivative Works; and
4. If the Work includes a "NOTICE" text file as part of its distribution, then any Derivative Works that You distribute must include a readable copy of the attribution notices contained within such NOTICE file, excluding those notices that do not pertain to any part of the Derivative Works, in at least one of the following places: within a NOTICE text file distributed as part of the Derivative Works; within the Source form or documentation, if provided along with the Derivative Works; or, within a display generated by the Derivative Works, if and wherever such third-party notices normally appear. The contents of the NOTICE file are for informational purposes only and do not modify the License. You may add Your own attribution notices within Derivative Works that You distribute, alongside or as an addendum to the NOTICE text from the Work, provided that such additional attribution notices cannot be construed as modifying the License. You may add Your own copyright statement to Your modifications and may provide additional or different license terms and conditions for use, reproduction, or distribution of Your modifications, or for any such Derivative Works as a whole, provided Your use, reproduction, and distribution of the Work otherwise complies with the conditions stated in this License.

5. Submission of Contributions. Unless You explicitly state otherwise, any Contribution intentionally submitted for inclusion in the Work by You to the Licensor shall be under the terms and conditions of this License, without any additional terms or conditions. Notwithstanding the above, nothing herein shall supersede or modify the terms of any separate license agreement you may have executed with Licensor regarding such Contributions.

6. Trademarks. This License does not grant permission to use the trade names, trademarks, service marks, or product names of the Licensor, except as required for reasonable and customary use in describing the origin of the Work and reproducing the content of the NOTICE file.

7. Disclaimer of Warranty. Unless required by applicable law or agreed to in writing, Licensor provides the Work (and each Contributor provides its Contributions) on an "AS IS" BASIS, WITHOUT WARRANTIES OR CONDITIONS OF ANY KIND, either express or implied, including, without limitation, any warranties or conditions of TITLE, NON-INFRINGEMENT, MERCHANTABILITY, or FITNESS FOR A PARTICULAR PURPOSE. You are solely responsible for determining the appropriateness of using or redistributing the Work and assume any risks associated with Your exercise of permissions under this License.

8. Limitation of Liability. In no event and under no legal theory, whether in tort (including negligence), contract, or otherwise, unless required by applicable law (such as deliberate and grossly negligent acts) or agreed to in writing, shall any Contributor be liable to You for damages, including any direct, indirect, special, incidental, or consequential damages of any character arising as a result of this License or out of the use or inability to use the Work (including but not limited to damages for loss of goodwill, work stoppage, computer failure or malfunction, or any and all other commercial damages or losses), even if such Contributor has been advised of the possibility of such damages.

9. Accepting Warranty or Additional Liability. While redistributing the Work or Derivative Works thereof, You may choose to offer, and charge a fee for, acceptance of support, warranty, indemnity, or other liability obligations and/or rights consistent with this License. However, in accepting such obligations, You may act only on Your own behalf and on Your sole responsibility, not on behalf of any other Contributor, and only if You agree to indemnify, defend, and hold each Contributor harmless for any liability incurred by, or claims asserted against, such Contributor by reason of your accepting any such warranty or additional liability.

END OF TERMS AND CONDITIONS

APPENDIX: How to apply the Apache License to your work

To apply the Apache License to your work, attach the following boilerplate notice, with the fields enclosed by brackets "[]" replaced with your own identifying information. (Don't include the brackets!) The text should be enclosed in the appropriate comment syntax for the file format. We also recommend that a file or class name and description of purpose be included on the same "printed page" as the copyright notice for easier identification within third-party archives.

```
Copyright [yyyy] [name of copyright owner]
```

```
Licensed under the Apache License, Version 2.0 (the "License");  
you may not use this file except in compliance with the License.  
You may obtain a copy of the License at
```

```
http://www.apache.org/licenses/LICENSE-2.0
```

```
Unless required by applicable law or agreed to in writing, software  
distributed under the License is distributed on an "AS IS" BASIS,  
WITHOUT WARRANTIES OR CONDITIONS OF ANY KIND, either  
express or implied.  
See the License for the specific language governing permissions  
and limitations under the License.
```

EPL 1.0

As we did not modify the Eclipse Project, Eclipse Equinox, org.eclipse.osgi, osgi-vaadin-demo, groovy-eclipse, org.apache.commons.codec_1.3.0.v201101211617.jar and rhf-competitions, we have no obligation to distribute the source code.

Copyright (c)

- Eclipse Equinox (2007, IBM Corporation, Cognos Incorporated and others. All Rights Reserved.)

THE ACCOMPANYING PROGRAM IS PROVIDED UNDER THE TERMS OF THIS ECLIPSE PUBLIC LICENSE ("AGREEMENT"). ANY USE, REPRODUCTION OR DISTRIBUTION OF THE PROGRAM CONSTITUTES RECIPIENT'S ACCEPTANCE OF THIS AGREEMENT.

1. DEFINITIONS

"Contribution" means:

- a) in the case of the initial Contributor, the initial code and documentation distributed under this Agreement, and
- b) in the case of each subsequent Contributor:
 - i) changes to the Program, and
 - ii) additions to the Program;

where such changes and/or additions to the Program originate from and are distributed by that particular Contributor. A Contribution 'originates' from a Contributor if it was added to the Program by such Contributor itself or anyone acting on such Contributor's behalf. Contributions do not include additions to the Program which: (i) are separate modules of software distributed in conjunction with the Program under their own license agreement, and (ii) are not derivative works of the Program.

"Contributor" means any person or entity that distributes the Program.

"Licensed Patents" mean patent claims licensable by a Contributor which are necessarily infringed by the use or sale of its Contribution alone or when combined with the Program.

"Program" means the Contributions distributed in accordance with this Agreement.

"Recipient" means anyone who receives the Program under this Agreement, including all Contributors.

2. GRANT OF RIGHTS

- a) Subject to the terms of this Agreement, each Contributor hereby grants Recipient a non-exclusive, worldwide, royalty-free copyright license to reproduce, prepare derivative works of, publicly display, publicly perform, distribute and sublicense the Contribution of such Contributor, if any, and such derivative works, in source code and object code form.
- b) Subject to the terms of this Agreement, each Contributor hereby grants Recipient a non-exclusive, worldwide, royalty-free patent license under Licensed Patents to make, use, sell, offer to sell, import and otherwise transfer the Contribution of such Contributor, if any, in source code and object code form. This patent license shall apply to the combination of the Contribution and the Program if, at the time the Contribution is added by the Contributor, such addition of the Contribution causes such combination to be covered by the Licensed Patents. The patent license shall not apply to any other combinations which include the Contribution. No hardware per se is licensed hereunder.
- c) Recipient understands that although each Contributor grants the licenses to its Contributions set forth herein, no assurances are provided by any Contributor that the Program does not infringe the patent or other intellectual property rights of any other entity. Each Contributor disclaims any liability to Recipient for claims brought by any other entity based on infringement of intellectual property rights or otherwise. As a condition to exercising the rights and licenses granted hereunder, each Recipient hereby assumes sole responsibility to secure any other intellectual property rights needed, if any. For example, if a third party patent license is required to allow Recipient to distribute the Program, it is Recipient's responsibility to acquire that license before distributing the Program.
- d) Each Contributor represents that to its knowledge it has sufficient copyright rights in its Contribution, if any, to grant the copyright license set forth in this Agreement.

3. REQUIREMENTS

A Contributor may choose to distribute the Program in object code form under its own license agreement, provided that:

- a) it complies with the terms and conditions of this Agreement; and
- b) its license agreement:
 - i) effectively disclaims on behalf of all Contributors all warranties and conditions, express and implied, including warranties or conditions of title and non-infringement, and implied warranties or conditions of merchantability and fitness for a particular purpose;
 - ii) effectively excludes on behalf of all Contributors all liability for damages, including direct, indirect, special, incidental and consequential damages, such as lost profits;
 - iii) states that any provisions which differ from this Agreement are offered by that Contributor alone and not by any other party; and
 - iv) states that source code for the Program is available from such Contributor, and informs licensees how to obtain it in a reasonable manner on or through a medium customarily used for software exchange.

When the Program is made available in source code form:

- a) it must be made available under this Agreement; and
- b) a copy of this Agreement must be included with each copy of the Program.

Contributors may not remove or alter any copyright notices contained within the Program.

Each Contributor must identify itself as the originator of its Contribution, if any, in a manner that reasonably allows subsequent Recipients to identify the originator of the Contribution.

4. COMMERCIAL DISTRIBUTION

Commercial distributors of software may accept certain responsibilities with respect to end users, business partners and the like. While this license is intended to facilitate the commercial use of the Program, the Contributor who includes the Program in a commercial product offering should do so in a manner which does not create potential liability for other Contributors. Therefore, if a Contributor includes the Program in a commercial product offering, such Contributor ("Commercial Contributor") hereby agrees to defend and indemnify every other Contributor ("Indemnified Contributor") against any losses, damages and costs (collectively "Losses") arising from claims, lawsuits and other legal actions brought by a third party against the Indemnified Contributor to the extent caused by the acts or omissions of such Commercial Contributor in connection with its distribution of the Program in a commercial product offering. The obligations in this section do not apply to any claims or Losses relating to any actual or alleged intellectual property infringement. In order to qualify, an Indemnified Contributor must: a) promptly notify the Commercial Contributor in writing of such claim, and b) allow the Commercial Contributor to control, and cooperate with the Commercial Contributor in, the defense and any related settlement negotiations. The Indemnified Contributor may participate in any such claim at its own expense.

For example, a Contributor might include the Program in a commercial product offering, Product X. That Contributor is then a Commercial Contributor. If that Commercial Contributor then makes performance claims, or offers warranties related to Product X, those performance claims and warranties are such Commercial Contributor's responsibility alone. Under this section, the Commercial Contributor would have to defend claims against the other Contributors related to those performance claims and warranties, and if a court requires any other Contributor to pay any damages as a result, the Commercial Contributor must pay those damages.

5. NO WARRANTY

EXCEPT AS EXPRESSLY SET FORTH IN THIS AGREEMENT, THE PROGRAM IS PROVIDED ON AN "AS IS" BASIS, WITHOUT WARRANTIES OR CONDITIONS OF ANY KIND, EITHER EXPRESS OR IMPLIED INCLUDING, WITHOUT LIMITATION, ANY WARRANTIES OR CONDITIONS OF TITLE, NON-INFRINGEMENT, MERCHANTABILITY OR FITNESS FOR A PARTICULAR PURPOSE. Each Recipient is solely responsible for determining the appropriateness of using and distributing the Program and assumes all risks associated with its exercise of rights under this Agreement, including but not limited to the risks and costs of program errors, compliance with applicable laws, damage to or loss of data, programs or equipment, and unavailability or interruption of operations.

6. DISCLAIMER OF LIABILITY

EXCEPT AS EXPRESSLY SET FORTH IN THIS AGREEMENT, NEITHER RECIPIENT NOR ANY CONTRIBUTORS SHALL HAVE ANY LIABILITY FOR ANY DIRECT, INDIRECT, INCIDENTAL, SPECIAL, EXEMPLARY, OR CONSEQUENTIAL DAMAGES (INCLUDING WITHOUT LIMITATION LOST PROFITS), HOWEVER CAUSED AND ON ANY THEORY OF LIABILITY, WHETHER IN CONTRACT, STRICT LIABILITY, OR TORT (INCLUDING NEGLIGENCE OR OTHERWISE) ARISING IN ANY WAY OUT OF THE USE OR DISTRIBUTION OF THE PROGRAM OR THE EXERCISE OF ANY RIGHTS GRANTED HEREUNDER, EVEN IF ADVISED OF THE POSSIBILITY OF SUCH DAMAGES.

7. GENERAL

If any provision of this Agreement is invalid or unenforceable under applicable law, it shall not affect the validity or enforceability of the remainder of the terms of this Agreement, and without further action by the parties hereto, such provision shall be reformed to the minimum extent necessary to make such provision valid and enforceable.

If Recipient institutes patent litigation against any entity (including a cross-claim or counterclaim in a lawsuit) alleging that the Program itself (excluding combinations of the Program with other software or hardware) infringes such Recipient's patent(s), then such Recipient's rights granted under Section 2(b) shall terminate as of the date such litigation is filed.

All Recipient's rights under this Agreement shall terminate if it fails to comply with any of the material terms or conditions of this Agreement and does not cure such failure in a reasonable period of time after becoming aware of such noncompliance. If all Recipient's rights under this Agreement terminate, Recipient agrees to cease use and distribution of the Program as soon as reasonably practicable. However, Recipient's obligations under this Agreement and any licenses granted by Recipient relating to the Program shall continue and survive.

Everyone is permitted to copy and distribute copies of this Agreement, but in order to avoid inconsistency the Agreement is copyrighted and may only be modified in the following manner. The Agreement Steward reserves the right to publish new versions (including revisions) of this Agreement from time to time. No one other than the Agreement Steward has the right to modify this Agreement. The Eclipse Foundation is the initial Agreement Steward. The Eclipse Foundation may assign the responsibility to serve as the Agreement Steward to a suitable separate entity. Each new version of the Agreement will be given a distinguishing version number. The Program (including Contributions) may always be distributed subject to the version of the Agreement under which it was received. In addition, after a new version of the Agreement is published, Contributor may elect to distribute the Program (including its Contributions) under the new version. Except as expressly stated in Sections 2(a) and 2(b) above, Recipient receives no rights or licenses to the intellectual property of any Contributor under this Agreement, whether expressly, by implication, estoppel or otherwise. All rights in the Program not expressly granted under this Agreement are reserved.

This Agreement is governed by the laws of the State of New York and the intellectual property laws of the United States of America. No party to this Agreement will bring a legal action under this Agreement more than one year after the cause of action arose. Each party waives its rights to a jury trial in any resulting litigation.

CDDL 1.1

As we did not modify the GlassFish, JSR-311 - JAX-RS - The Java API for RESTful Web Services (Jersey), jersey-bundle and browser-detect, we have no obligation to distribute the source code.

- Glassfish (2010, Oracle and/or its affiliates. All rights reserved.)
- JSR-311 - JAX-RS - The Java API for RESTful Web Services (Jersey) (2010-2014, Oracle Corporation)
- jersey-bundle (2010-2014, Oracle Corporation)
- browser-detect (2003, by Stephen Chapman, Felgall Pty Ltd)

1. Definitions.

- 1.1. "Contributor" means each individual or entity that creates or contributes to the creation of Modifications.
- 1.2. "Contributor Version" means the combination of the Original Software, prior Modifications used by a Contributor (if any), and the Modifications made by that particular Contributor.
- 1.3. "Covered Software" means (a) the Original Software, or (b) Modifications, or (c) the combination of files containing Original Software with files containing Modifications, in each case including portions thereof.
- 1.4. "Executable" means the Covered Software in any form other than Source Code.
- 1.5. "Initial Developer" means the individual or entity that first makes Original Software available under this License.
- 1.6. "Larger Work" means a work which combines Covered Software or portions thereof with code not governed by the terms of this License.
- 1.7. "License" means this document.
- 1.8. "Licensable" means having the right to grant, to the maximum extent possible, whether at the time of the initial grant or subsequently acquired, any and all of the rights conveyed herein.
- 1.9. "Modifications" means the Source Code and Executable form of any of the following:
 - A. Any file that results from an addition to, deletion from or modification of the contents of a file containing Original Software or previous Modifications;
 - B. Any new file that contains any part of the Original Software or previous Modification; or
 - C. Any new file that is contributed or otherwise made available under the terms of this License.
- 1.10. "Original Software" means the Source Code and Executable form of computer software code that is originally released under this License.
- 1.11. "Patent Claims" means any patent claim(s), now owned or hereafter acquired, including without limitation, method, process, and apparatus claims, in any patent Licensable by grantor.

1.12. "Source Code" means (a) the common form of computer software code in which modifications are made and (b) associated documentation included in or with such code.

1.13. "You" (or "Your") means an individual or a legal entity exercising rights under, and complying with all of the terms of, this License. For legal entities, "You" includes any entity which controls, is controlled by, or is under common control with You. For purposes of this definition, "control" means (a) the power, direct or indirect, to cause the direction or management of such entity, whether by contract or otherwise, or (b) ownership of more than fifty percent (50%) of the outstanding shares or beneficial ownership of such entity.

2. License Grants.

2.1. The Initial Developer Grant.

Conditioned upon Your compliance with Section 3.1 below and subject to third party intellectual property claims, the Initial Developer hereby grants You a world-wide, royalty-free, non-exclusive license:

- (a) under intellectual property rights (other than patent or trademark) Licensable by Initial Developer, to use, reproduce, modify, display, perform, sublicense and distribute the Original Software (or portions thereof), with or without Modifications, and/or as part of a Larger Work; and
- (b) under Patent Claims infringed by the making, using or selling of Original Software, to make, have made, use, practice, sell, and offer for sale, and/or otherwise dispose of the Original Software (or portions thereof).
- (c) The licenses granted in Sections 2.1(a) and (b) are effective on the date Initial Developer first distributes or otherwise makes the Original Software available to a third party under the terms of this License.
- (d) Notwithstanding Section 2.1(b) above, no patent license is granted: (1) for code that You delete from the Original Software, or (2) for infringements caused by: (i) the modification of the Original Software, or (ii) the combination of the Original Software with other software or devices.

2.2. Contributor Grant.

Conditioned upon Your compliance with Section 3.1 below and subject to third party intellectual property claims, each Contributor hereby grants You a world-wide, royalty-free, non-exclusive license:

- (a) under intellectual property rights (other than patent or trademark) Licensable by Contributor to use, reproduce, modify, display, perform, sublicense and distribute the Modifications created by such Contributor (or portions thereof), either on an unmodified basis, with other Modifications, as Covered Software and/or as part of a Larger Work; and
- (b) under Patent Claims infringed by the making, using, or selling of Modifications made by that Contributor either alone and/or in combination with its Contributor Version (or portions of such combination), to make, use, sell, offer for sale, have made, and/or otherwise dispose of: (1) Modifications made by that Contributor (or portions thereof); and (2) the combination of Modifications made by that Contributor with its Contributor Version (or portions of such combination).
- (c) The licenses granted in Sections 2.2(a) and 2.2(b) are effective on the date Contributor first distributes or otherwise makes the Modifications available to a third party.
- (d) Notwithstanding Section 2.2(b) above, no patent license is granted:
 - (1) for any code that Contributor has deleted from the Contributor Version;
 - (2) for infringements caused by: (i) third party modifications of Contributor Version, or (ii) the combination of Modifications made by that Contributor with other software (except as part of the Contributor Version) or other devices; or
 - (3) under Patent Claims infringed by Covered Software in the absence of Modifications made by that Contributor.

3. Distribution Obligations.

3.1. Availability of Source Code.

Any Covered Software that You distribute or otherwise make available in Executable form must also be made available in Source Code form and that Source Code form must be distributed only under the terms of this License. You must include a copy of this License with every copy of the Source Code form of the Covered Software You distribute or otherwise make available. You must inform recipients of any such Covered Software in Executable form as to how they can obtain such Covered Software in Source Code form in a reasonable manner on or through a medium customarily used for software exchange.

3.2. Modifications.

The Modifications that You create or to which You contribute are governed by the terms of this License. You represent that You believe Your Modifications are Your original creation(s) and/or You have sufficient rights to grant the rights conveyed by this License.

3.3. Required Notices.

You must include a notice in each of Your Modifications that identifies You as the Contributor of the Modification. You may not remove or alter any copyright, patent or trademark notices contained within the Covered Software, or any notices of licensing or any descriptive text giving attribution to any Contributor or the Initial Developer.

3.4. Application of Additional Terms.

You may not offer or impose any terms on any Covered Software in Source Code form that alters or restricts the applicable version of this License or the recipients' rights hereunder. You may choose to offer, and to charge a fee for, warranty, support, indemnity or liability obligations to one or more recipients of Covered Software. However, you may do so only on Your own behalf, and not on behalf of the Initial Developer or any Contributor. You must make it absolutely clear that any such warranty, support, indemnity or liability obligation is offered by You alone, and You hereby agree to indemnify the Initial Developer and every Contributor for any liability incurred by the Initial Developer or such Contributor as a result of warranty, support, indemnity or liability terms You offer.

3.5. Distribution of Executable Versions.

You may distribute the Executable form of the Covered Software under the terms of this License or under the terms of a license of Your choice, which may contain terms different from this License, provided that You are in compliance with the terms of this License and that the license for the Executable form does not attempt to limit or alter the recipient's rights in the Source Code form from the rights set forth in this License. If You distribute the Covered Software in Executable form under a different license, You must make it absolutely clear that any terms which differ from this License are offered by You alone, not by the Initial Developer or Contributor. You hereby agree to indemnify the Initial Developer and every Contributor for any liability incurred by the Initial Developer or such Contributor as a result of any such terms You offer.

3.6. Larger Works.

You may create a Larger Work by combining Covered Software with other code not governed by the terms of this License and distribute the Larger Work as a single product. In such a case, You must make sure the requirements of this License are fulfilled for the Covered Software.

4. Versions of the License.

4.1. New Versions.

Oracle is the initial license steward and may publish revised and/or new versions of this License from time to time. Each version will be given a distinguishing version number. Except as provided in Section 4.3, no one other than the license steward has the right to modify this License.

4.2. Effect of New Versions.

You may always continue to use, distribute or otherwise make the Covered Software available under the terms of the version of the License under which You originally received the Covered Software. If the Initial Developer includes a notice in the Original Software prohibiting it from being distributed or otherwise made available under any subsequent version of the License, You must distribute and make the Covered Software available under the terms of the version of the License under which You originally received the Covered Software. Otherwise, You may also choose to use, distribute or otherwise make the Covered Software available under the terms of any subsequent version of the License published by the license steward.

4.3. Modified Versions.

When You are an Initial Developer and You want to create a new license for Your Original Software, You may create and use a modified version of this License if You: (a) rename the license and remove any references to the name of the license steward (except to note that the license differs from this License); and (b) otherwise make it clear that the license contains terms which differ from this License.

5. DISCLAIMER OF WARRANTY.

COVERED SOFTWARE IS PROVIDED UNDER THIS LICENSE ON AN "AS IS" BASIS, WITHOUT WARRANTY OF ANY KIND, EITHER EXPRESSED OR IMPLIED, INCLUDING, WITHOUT LIMITATION, WARRANTIES THAT THE COVERED SOFTWARE IS FREE OF DEFECTS, MERCHANTABILITY, FIT FOR A PARTICULAR PURPOSE OR NON-INFRINGEMENT. THE ENTIRE RISK AS TO THE QUALITY AND PERFORMANCE OF THE COVERED SOFTWARE IS WITH YOU. SHOULD ANY COVERED SOFTWARE PROVE DEFECTIVE

IN ANY RESPECT, YOU (NOT THE INITIAL DEVELOPER OR ANY OTHER CONTRIBUTOR) ASSUME THE COST OF ANY NECESSARY SERVICING, REPAIR OR CORRECTION. THIS DISCLAIMER OF WARRANTY CONSTITUTES AN ESSENTIAL PART OF THIS LICENSE. NO USE OF ANY COVERED SOFTWARE IS AUTHORIZED HEREUNDER EXCEPT UNDER THIS DISCLAIMER.

6. TERMINATION.

6.1. This License and the rights granted hereunder will terminate automatically if You fail to comply with terms herein and fail to cure such breach within 30 days of becoming aware of the breach. Provisions which, by their nature, must remain in effect beyond the termination of this License shall survive.

6.2. If You assert a patent infringement claim (excluding declaratory judgment actions) against Initial Developer or a Contributor (the Initial Developer or Contributor against whom You assert such claim is referred to as "Participant") alleging that the Participant Software (meaning the Contributor Version where the Participant is a Contributor or the Original Software where the Participant is the Initial Developer) directly or indirectly infringes any patent, then any and all rights granted directly or indirectly to You by such Participant, the Initial Developer (if the Initial Developer is not the Participant) and all Contributors under Sections 2.1 and/or 2.2 of this License shall, upon 60 days notice from Participant terminate prospectively and automatically at the expiration of such 60 day notice period, unless if within such 60 day period You withdraw Your claim with respect to the Participant Software against such Participant either unilaterally or pursuant to a written agreement with Participant.

6.3. If You assert a patent infringement claim against Participant alleging that the Participant Software directly or indirectly infringes any patent where such claim is resolved (such as by license or settlement) prior to the initiation of patent infringement litigation, then the reasonable value of the licenses granted by such Participant under Sections 2.1 or 2.2 shall be taken into account in determining the amount or value of any payment or license.

6.4. In the event of termination under Sections 6.1 or 6.2 above, all end user licenses that have been validly granted by You or any distributor hereunder prior to termination (excluding licenses granted to You by any distributor) shall survive termination.

7. LIMITATION OF LIABILITY.

UNDER NO CIRCUMSTANCES AND UNDER NO LEGAL THEORY, WHETHER TORT (INCLUDING NEGLIGENCE), CONTRACT, OR OTHERWISE, SHALL YOU, THE INITIAL DEVELOPER, ANY OTHER CONTRIBUTOR, OR ANY DISTRIBUTOR OF COVERED SOFTWARE, OR ANY SUPPLIER OF ANY OF SUCH PARTIES, BE LIABLE TO ANY PERSON FOR ANY INDIRECT, SPECIAL, INCIDENTAL, OR CONSEQUENTIAL DAMAGES OF ANY CHARACTER INCLUDING, WITHOUT LIMITATION, DAMAGES FOR LOSS OF GOODWILL, WORK STOPPAGE, COMPUTER FAILURE OR MALFUNCTION, OR ANY AND ALL OTHER COMMERCIAL DAMAGES OR LOSSES, EVEN IF SUCH PARTY SHALL HAVE BEEN INFORMED OF THE POSSIBILITY OF SUCH DAMAGES. THIS LIMITATION OF LIABILITY SHALL NOT APPLY TO LIABILITY FOR DEATH OR PERSONAL INJURY RESULTING FROM SUCH PARTY'S NEGLIGENCE TO THE EXTENT APPLICABLE LAW PROHIBITS SUCH LIMITATION. SOME JURISDICTIONS DO NOT ALLOW THE EXCLUSION OR LIMITATION OF INCIDENTAL OR CONSEQUENTIAL DAMAGES, SO THIS EXCLUSION AND LIMITATION MAY NOT APPLY TO YOU.

8. U.S. GOVERNMENT END USERS.

The Covered Software is a "commercial item," as that term is defined in 48 C.F.R. 2.101 (Oct. 1995), consisting of "commercial computer software" (as that term is defined at 48 C.F.R. § 252.227-7014(a)(1)) and "commercial computer software documentation" as such terms are used in 48 C.F.R. 12.212 (Sept. 1995). Consistent with 48 C.F.R. 12.212 and 48 C.F.R. 227.7202-1 through 227.7202-4 (June 1995), all U.S. Government End Users acquire Covered Software with only those rights set forth herein. This U.S. Government Rights clause is in lieu of, and supersedes, any other FAR, DFAR, or other clause or provision that addresses Government rights in computer software under this License.

9. MISCELLANEOUS.

This License represents the complete agreement concerning subject matter hereof. If any provision of this License is held to be unenforceable, such provision shall be reformed only to the extent necessary to make it enforceable. This License shall be governed by the law of the jurisdiction specified in a notice contained within the Original Software (except to the extent applicable law, if any, provides otherwise), excluding such jurisdiction's conflict-of-law provisions. Any litigation relating to this License shall be subject to the jurisdiction of the courts located in the jurisdiction and venue specified in a notice contained within the Original Software, with the losing party responsible for costs, including, without limitation, court

costs and reasonable attorneys' fees and expenses. The application of the United Nations Convention on Contracts for the International Sale of Goods is expressly excluded. Any law or regulation which provides that the language of a contract shall be construed against the drafter shall not apply to this License. You agree that You alone are responsible for compliance with the United States export administration regulations (and the export control laws and regulation of any other countries) when You use, distribute or otherwise make available any Covered Software.

10. RESPONSIBILITY FOR CLAIMS.

As between Initial Developer and the Contributors, each party is responsible for claims and damages arising, directly or indirectly, out of its utilization of rights under this License and You agree to work with Initial Developer and Contributors to distribute such responsibility on an equitable basis. Nothing herein is intended or shall be deemed to constitute any admission of liability.

NOTICE PURSUANT TO SECTION 9 OF THE COMMON DEVELOPMENT AND DISTRIBUTION LICENSE (CDDL)

The code released under the CDDL shall be governed by the laws of the State of California (excluding conflict-of-law provisions). Any litigation relating to this License shall be subject to the jurisdiction of the Federal Courts of the Northern District of California and the state courts of the State of California, with venue lying in Santa Clara County, California.

Code Project Open 1.02 License

Copyright (c)

- Code Project – AlphaBlendTextBox – A transparent/translucent textbox for .NET (2003, Bob Bradley)
- Code Project – Animating Windows Forms (2006, Robert Rohde)
- Code Project – BarTender – Group your contents (2006, Robert Rohde)
- Code Project – Cabinet File (*.CAB) Compression and Extraction (2012, Elmue)
- Code Project – Data Encryption/Decryption using RijndaelManaged and PasswordDeriveByt (2006, Nidheesh T Mani)
- Code Project – How to skin scrollbars for Panels, in C# (2006, Greg Ellis)
- Code Project – Windows Management Instrumentation (WMI) Implementation (2002, Paul Li)
- Code Project - WPF TreeListView Control (2012, Andrey Gliznetsov)
- Code Project - Creating an XML file based on XSD (2006, jebaronson)
- Code Project - A reusable, high performance, socket server class - Part 1 (2002, Len Holgate)
- Code Project - Install Windows Service using Custom Action (2010, lata07mah)

Preamble

This License governs Your use of the Work. This License is intended to allow developers to use the Source Code and Executable Files provided as part of the Work in any application in any form.

The main points subject to the terms of the License are:

- Source Code and Executable Files can be used in commercial applications;
- Source Code and Executable Files can be redistributed; and
- Source Code can be modified to create derivative works.
- No claim of suitability, guarantee, or any warranty whatsoever is provided. The software is provided "as-is".
- The Article accompanying the Work may not be distributed or republished without the Author's consent

This License is entered between You, the individual or other entity reading or otherwise making use of the Work licensed pursuant to this License and the individual or other entity which offers the Work under the terms of this License ("Author").

License

THE WORK (AS DEFINED BELOW) IS PROVIDED UNDER THE TERMS OF THIS CODE PROJECT OPEN LICENSE ("LICENSE"). THE WORK IS PROTECTED BY COPYRIGHT AND/OR OTHER APPLICABLE LAW. ANY USE OF THE WORK OTHER THAN AS AUTHORIZED UNDER THIS LICENSE OR COPYRIGHT LAW IS PROHIBITED.

BY EXERCISING ANY RIGHTS TO THE WORK PROVIDED HEREIN, YOU ACCEPT AND AGREE TO BE BOUND BY THE TERMS OF THIS LICENSE. THE AUTHOR GRANTS YOU THE RIGHTS CONTAINED HEREIN IN CONSIDERATION OF YOUR ACCEPTANCE OF SUCH TERMS AND CONDITIONS. IF YOU DO NOT AGREE TO ACCEPT AND BE BOUND BY THE TERMS OF THIS LICENSE, YOU CANNOT MAKE ANY USE OF THE WORK.

1. Definitions.

- a. "**Articles**" means, collectively, all articles written by Author which describes how the Source Code and Executable Files for the Work may be used by a user.
- b. "**Author**" means the individual or entity that offers the Work under the terms of this License.
- c. "**Derivative Work**" means a work based upon the Work or upon the Work and other pre-existing works.
- d. "**Executable Files**" refer to the executables, binary files, configuration and any required data files included in the Work.
- e. "**Publisher**" means the provider of the website, magazine, CD-ROM, DVD or other medium from or by which the Work is obtained by You.
- f. "**Source Code**" refers to the collection of source code and configuration files used to create the Executable Files.
- g. "**Standard Version**" refers to such a Work if it has not been modified, or has been modified in accordance with the consent of the Author, such consent being in the full discretion of the Author.
- h. "**Work**" refers to the collection of files distributed by the Publisher, including the Source Code, Executable Files, binaries, data files, documentation, whitepapers and the Articles.
- i. "**You**" is you, an individual or entity wishing to use the Work and exercise your rights under this License.

2. **Fair Use/Fair Use Rights.** Nothing in this License is intended to reduce, limit, or restrict any rights arising from fair use, fair dealing, first sale or other limitations on the exclusive rights of the copyright owner under copyright law or other applicable laws.

3. **License Grant.** Subject to the terms and conditions of this License, the Author hereby grants You a worldwide, royalty-free, non-exclusive, perpetual (for the duration of the applicable copyright) license to exercise the rights in the Work as stated below:

- a. You may use the standard version of the Source Code or Executable Files in Your own applications.
- b. You may apply bug fixes, portability fixes and other modifications obtained from the Public Domain or from the Author. A Work modified in such a way shall still be considered the standard version and will be subject to this License.
- c. You may otherwise modify Your copy of this Work (excluding the Articles) in any way to create a Derivative Work, provided that You insert a prominent notice in each changed file stating how, when and where You changed that file.
- d. You may distribute the standard version of the Executable Files and Source Code or Derivative Work in aggregate with other (possibly commercial) programs as part of a larger (possibly commercial) software distribution.
- e. The Articles discussing the Work published in any form by the author may not be distributed or republished without the Author's consent. The author retains copyright to any such Articles. You may use the Executable Files and Source Code pursuant to this License but you may not repost or republish or otherwise distribute or make available the Articles, without the prior written consent of the Author. Any subroutines or modules supplied by You and linked into the Source Code or Executable Files of this Work shall not be considered part of this Work and will not be subject to the terms of this License.

4. **Patent License.** Subject to the terms and conditions of this License, each Author hereby grants to You a perpetual, worldwide, non-exclusive, no-charge, royalty-free, irrevocable (except as stated in this section) patent license to make, have made, use, import, and otherwise transfer the Work.

5. **Restrictions.** The license granted in Section 3 above is expressly made subject to and limited by the following restrictions:

- a. You agree not to remove any of the original copyright, patent, trademark, and attribution notices and associated disclaimers that may appear in the Source Code or Executable Files.
- b. You agree not to advertise or in any way imply that this Work is a product of Your own.
- c. The name of the Author may not be used to endorse or promote products derived from the Work without the prior written consent of the Author.
- d. You agree not to sell, lease, or rent any part of the Work. This does not restrict you from including the Work or any part of the Work inside a larger software distribution that itself is being sold. The Work by itself, though, cannot be sold, leased or rented.
- e. You may distribute the Executable Files and Source Code only under the terms of this License, and You must include a copy of, or the Uniform Resource Identifier for, this License with every copy of the Executable Files or Source Code You distribute and ensure that

anyone receiving such Executable Files and Source Code agrees that the terms of this License apply to such Executable Files and/or Source Code. You may not offer or impose any terms on the Work that alter or restrict the terms of this License or the recipients' exercise of the rights granted hereunder. You may not sublicense the Work. You must keep intact all notices that refer to this License and to the disclaimer of warranties. You may not distribute the Executable Files or Source Code with any technological measures that control access or use of the Work in a manner inconsistent with the terms of this License.

f. You agree not to use the Work for illegal, immoral or improper purposes, or on pages containing illegal, immoral or improper material. The Work is subject to applicable export laws. You agree to comply with all such laws and regulations that may apply to the Work after Your receipt of the Work.

6. **Representations, Warranties and Disclaimer.** THIS WORK IS PROVIDED "AS IS", "WHERE IS" AND "AS AVAILABLE", WITHOUT ANY EXPRESS OR IMPLIED WARRANTIES OR CONDITIONS OR GUARANTEES. YOU, THE USER, ASSUME ALL RISK IN ITS USE, INCLUDING COPYRIGHT INFRINGEMENT, PATENT INFRINGEMENT, SUITABILITY, ETC. AUTHOR EXPRESSLY DISCLAIMS ALL EXPRESS, IMPLIED OR STATUTORY WARRANTIES OR CONDITIONS, INCLUDING WITHOUT LIMITATION, WARRANTIES OR CONDITIONS OF MERCHANTABILITY, MERCHANTABLE QUALITY OR FITNESS FOR A PARTICULAR PURPOSE, OR ANY WARRANTY OF TITLE OR NON-INFRINGEMENT, OR THAT THE WORK (OR ANY PORTION THEREOF) IS CORRECT, USEFUL, BUG-FREE OR FREE OF VIRUSES. YOU MUST PASS THIS DISCLAIMER ON WHENEVER YOU DISTRIBUTE THE WORK OR DERIVATIVE WORKS.

7. **Indemnity.** You agree to defend, indemnify and hold harmless the Author and the Publisher from and against any claims, suits, losses, damages, liabilities, costs, and expenses (including reasonable legal or attorneys' fees) resulting from or relating to any use of the Work by You.

8. **Limitation on Liability.** EXCEPT TO THE EXTENT REQUIRED BY APPLICABLE LAW, IN NO EVENT WILL THE AUTHOR OR THE PUBLISHER BE LIABLE TO YOU ON ANY LEGAL THEORY FOR ANY SPECIAL, INCIDENTAL, CONSEQUENTIAL, PUNITIVE OR EXEMPLARY DAMAGES ARISING OUT OF THIS LICENSE OR THE USE OF THE WORK OR OTHERWISE, EVEN IF THE AUTHOR OR THE PUBLISHER HAS BEEN ADVISED OF THE POSSIBILITY OF SUCH DAMAGES.

9. **Termination.**

a. This License and the rights granted hereunder will terminate automatically upon any breach by You of any term of this License. Individuals or entities who have received Derivative Works from You under this License, however, will not have their licenses terminated provided such individuals or entities remain in full compliance with those licenses. Sections 1, 2, 6, 7, 8, 9, 10 and 11 will survive any termination of this License.

b. If You bring a copyright, trademark, patent or any other infringement claim against any contributor over infringements You claim are made by the Work, your License from such contributor to the Work ends automatically.

c. Subject to the above terms and conditions, this License is perpetual (for the duration of the applicable copyright in the Work). Notwithstanding the above, the Author reserves the right to release the Work under different license terms or to stop distributing the Work at any time; provided, however that any such election will not serve to withdraw this License (or any other license that has been, or is required to be, granted under the terms of this License), and this License will continue in full force and effect unless terminated as stated above.

10. **Publisher.** The parties hereby confirm that the Publisher shall not, under any circumstances, be responsible for and shall not have any liability in respect of the subject matter of this License. The Publisher makes no warranty whatsoever in connection with the Work and shall not be liable to You or any party on any legal theory for any damages whatsoever, including without limitation any general, special, incidental or consequential damages arising in connection to this license. The Publisher reserves the right to cease making the Work available to You at any time without notice

11. **Miscellaneous**

a. This License shall be governed by the laws of the location of the head office of the Author or if the Author is an individual, the laws of location of the principal place of residence of the Author.

b. If any provision of this License is invalid or unenforceable under applicable law, it shall not affect the validity or enforceability of the remainder of the terms of this License, and without further action by the parties to this License, such provision shall be reformed to the minimum extent necessary to make such provision valid and enforceable.

c. No term or provision of this License shall be deemed waived and no breach consented to unless such waiver or consent shall be in writing and signed by the party to be charged with such waiver or consent.

d. This License constitutes the entire agreement between the parties with respect to the Work licensed herein. There are no understandings, agreements or representations with respect to the Work not specified herein. The Author shall not be bound by any additional provisions that may appear in any communication from You. This License may not be modified without the mutual written agreement of the Author and You.

GNU LESSER GENERAL PUBLIC LICENSE 2.1

We used the javastruct, JFreeChart - 1. JFreeChart, JFreeChart - 3. Jcommon and jna in our application and we did not modify the source code. We modified the Live555 in the source code and used it in our application.

Copyright(C)

- Live555 (1991, 1999 Free Software Foundation, Inc.)
- javastruct (2007 Free Software Foundation, Inc. <<http://fsf.org/>>)
- JFreeChart - 1. JFreeChart (2000-2004, by Object Refinery Limited and Contributors)
- JFreeChart - 3. Jcommon (2000-2004, by Object Refinery Limited and Contributors)
- jna (1991, 1999 Free Software Foundation, Inc.)

Version 2.1, February 1999

Copyright (C) 1991, 1999 Free Software Foundation, Inc.
51 Franklin Street, Fifth Floor, Boston, MA 02110-1301 USA
Everyone is permitted to copy and distribute verbatim copies of this license document, but changing it is not allowed.

[This is the first released version of the Lesser GPL. It also counts as the successor of the GNU Library Public License, version 2, hence the version number 2.1.]

Preamble

The licenses for most software are designed to take away your freedom to share and change it. By contrast, the GNU General Public Licenses are intended to guarantee your freedom to share and change free software--to make sure the software is free for all its users.

This license, the Lesser General Public License, applies to some specially designated software packages--typically libraries--of the Free Software Foundation and other authors who decide to use it. You can use it too, but we suggest you first think carefully about whether this license or the ordinary General Public License is the better strategy to use in any particular case, based on the explanations below.

When we speak of free software, we are referring to freedom of use, not price. Our General Public Licenses are designed to make sure that you have the freedom to distribute copies of free software (and charge for this service if you wish); that you receive source code or can get it if you want it; that you can change the software and use pieces of it in new free programs; and that you are informed that you can do these things.

To protect your rights, we need to make restrictions that forbid distributors to deny you these rights or to ask you to surrender these rights. These restrictions translate to certain responsibilities for you if you distribute copies of the library or if you modify it.

For example, if you distribute copies of the library, whether gratis or for a fee, you must give the recipients all the rights that we gave you. You must make sure that they, too, receive or can get the source code. If you link other code with the library, you must provide complete object files to the recipients, so that they can relink them with the library after making changes to the library and recompiling it. And you must show them these terms so they know their rights.

We protect your rights with a two-step method: (1) we copyright the library, and (2) we offer you this license, which gives you legal permission to copy, distribute and/or modify the library.

To protect each distributor, we want to make it very clear that there is no warranty for the free library. Also, if the library is modified by someone else and passed on, the recipients should know that what they have is not the original version, so that the original author's reputation will not be affected by problems that might be introduced by others.

Finally, software patents pose a constant threat to the existence of any free program. We wish to make sure that a company cannot effectively restrict the users of a free program by obtaining a restrictive license from a patent holder. Therefore, we insist that any patent license obtained for a version of the library must be consistent with the full freedom of use specified in this license.

Most GNU software, including some libraries, is covered by the ordinary GNU General Public License. This license, the GNU Lesser General Public License, applies to certain designated libraries, and is quite different from the ordinary General Public License. We use this license for certain libraries in order to permit linking those libraries into non-free programs.

When a program is linked with a library, whether statically or using a shared library, the combination of the two is legally speaking a combined work, a derivative of the original library. The ordinary General Public License therefore permits such linking only if the entire combination fits its criteria of freedom. The Lesser General Public License permits more lax criteria for linking other code with the library.

We call this license the "Lesser" General Public License because it does Less to protect the user's freedom than the ordinary General Public License. It also provides other free software developers Less of an advantage over competing non-free programs. These disadvantages are the reason we use the ordinary General Public License for many libraries. However, the Lesser license provides advantages in certain special circumstances.

For example, on rare occasions, there may be a special need to encourage the widest possible use of a certain library, so that it becomes a de-facto standard. To achieve this, non-free programs must be allowed to use the library. A more frequent case is that a free library does the same job as widely used non-free libraries. In this case, there is little to gain by limiting the free library to free software only, so we use the Lesser General Public License.

In other cases, permission to use a particular library in non-free programs enables a greater number of people to use a large body of free software. For example, permission to use the GNU C Library in non-free programs enables many more people to use the whole GNU operating system, as well as its variant, the GNU/Linux operating system.

Although the Lesser General Public License is Less protective of the users' freedom, it does ensure that the user of a program that is linked with the Library has the freedom and the wherewithal to run that program using a modified version of the Library.

The precise terms and conditions for copying, distribution and modification follow. Pay close attention to the difference between a "work based on the library" and a "work that uses the library". The former contains code derived from the library, whereas the latter must be combined with the library in order to run.

TERMS AND CONDITIONS FOR COPYING, DISTRIBUTION AND MODIFICATION

0. This License Agreement applies to any software library or other program which contains a notice placed by the copyright holder or other authorized party saying it may be distributed under the terms of this Lesser General Public License (also called "this License"). Each licensee is addressed as "you".

A "library" means a collection of software functions and/or data prepared so as to be conveniently linked with application programs (which use some of those functions and data) to form executables.

The "Library", below, refers to any such software library or work which has been distributed under these terms. A "work based on the Library" means either the Library or any derivative work under copyright law: that is to say, a work containing the Library or a portion of it, either verbatim or with modifications and/or translated straightforwardly into another language. (Hereinafter, translation is included without limitation in the term "modification".)

"Source code" for a work means the preferred form of the work for making modifications to it. For a library, complete source code means all the source code for all modules it contains, plus any associated interface definition files, plus the scripts used to control compilation and installation of the library.

Activities other than copying, distribution and modification are not covered by this License; they are outside its scope. The act of running a program using the Library is not restricted, and output from such a program is covered only if its contents constitute a work based on the Library (independent of the use of the Library in a tool for writing it). Whether that is true depends on what the Library does and what the program that uses the Library does.

1. You may copy and distribute verbatim copies of the Library's complete source code as you receive it, in any medium, provided that you conspicuously and appropriately publish on each copy an appropriate copyright notice and disclaimer of warranty; keep intact all the notices that refer to this License and to the absence of any warranty; and distribute a copy of this License along with the Library.

You may charge a fee for the physical act of transferring a copy, and you may at your option offer warranty protection in exchange for a fee.

2. You may modify your copy or copies of the Library or any portion of it, thus forming a work based on the Library, and copy and distribute such modifications or work under the terms of Section 1 above, provided that you also meet all of these conditions:

- a) The modified work must itself be a software library.
- b) You must cause the files modified to carry prominent notices stating that you changed the files and the date of any change.
- c) You must cause the whole of the work to be licensed at no charge to all third parties under the terms of this License.
- d) If a facility in the modified Library refers to a function or a table of data to be supplied by an application program that uses the facility, other than as an argument passed when the facility is invoked, then you must make a good faith effort to ensure that, in the event an application does not supply such function or table, the facility still operates, and performs whatever part of its purpose remains meaningful.

(For example, a function in a library to compute square roots has a purpose that is entirely well-defined independent of the application. Therefore, Subsection 2d requires that any application-supplied function or table used by this function must be optional: if the application does not supply it, the square root function must still compute square roots.)

These requirements apply to the modified work as a whole. If identifiable sections of that work are not derived from the Library, and can be reasonably considered independent and separate works in themselves, then this License, and its terms, do not apply to those sections when you distribute them as separate works. But when you distribute the same sections as part of a whole which is a work based on the Library, the distribution of the whole must be on the terms of this License, whose permissions for other licensees extend to the entire whole, and thus to each and every part regardless of who wrote it.

Thus, it is not the intent of this section to claim rights or contest your rights to work written entirely by you; rather, the intent is to exercise the right to control the distribution of derivative or collective works based on the Library.

In addition, mere aggregation of another work not based on the Library with the Library (or with a work based on the Library) on a volume of a storage or distribution medium does not bring the other work under the scope of this License.

3. You may opt to apply the terms of the ordinary GNU General Public License instead of this License to a given copy of the Library. To do this, you must alter all the notices that refer to this License, so that they refer to the ordinary GNU General Public License, version 2, instead of to this License. (If a newer version than version 2 of the ordinary GNU General Public License has appeared, then you can specify that version instead if you wish.) Do not make any other change in these notices.

Once this change is made in a given copy, it is irreversible for that copy, so the ordinary GNU General Public License applies to all subsequent copies and derivative works made from that copy.

This option is useful when you wish to copy part of the code of the Library into a program that is not a library.

4. You may copy and distribute the Library (or a portion or derivative of it, under Section 2) in object code or executable form under the terms of Sections 1 and 2 above provided that you accompany it with the complete corresponding machine-readable source code, which must be distributed under the terms of Sections 1 and 2 above on a medium customarily used for software interchange.

If distribution of object code is made by offering access to copy from a designated place, then offering equivalent access to copy the source code from the same place satisfies the requirement to distribute the source code, even though third parties are not compelled to copy the source along with the object code.

5. A program that contains no derivative of any portion of the Library, but is designed to work with the Library by being compiled or linked with it, is called a "work that uses the Library". Such a work, in isolation, is not a derivative work of the Library, and therefore falls outside the scope of this License.

However, linking a "work that uses the Library" with the Library creates an executable that is a derivative of the Library (because it contains portions of the Library), rather than a "work that uses the library". The executable is therefore covered by this License. Section 6 states terms for distribution of such executables.

When a "work that uses the Library" uses material from a header file that is part of the Library, the object code for the work may be a derivative work of the Library even though the source code is not. Whether this is true is especially significant if the work can be linked without the Library, or if the work is itself a library. The threshold for this to be true is not precisely defined by law.

If such an object file uses only numerical parameters, data structure layouts and accessors, and small macros and small inline functions (ten lines or less in length), then the use of the object file is unrestricted, regardless of whether it is legally a derivative work. (Executables containing this object code plus portions of the Library will still fall under Section 6.)

Otherwise, if the work is a derivative of the Library, you may distribute the object code for the work under the terms of Section 6. Any executables containing that work also fall under Section 6, whether or not they are linked directly with the Library itself.

6. As an exception to the Sections above, you may also combine or link a "work that uses the Library" with the Library to produce a work containing portions of the Library, and distribute that work under terms of your choice, provided that the terms permit modification of the work for the customer's own use and reverse engineering for debugging such modifications.

You must give prominent notice with each copy of the work that the Library is used in it and that the Library and its use are covered by this License. You must supply a copy of this License. If the work during execution displays copyright notices, you must include the copyright notice for the Library among them, as well as a reference directing the user to the copy of this License. Also, you must do one of these things:

a) Accompany the work with the complete corresponding machine-readable source code for the Library including whatever changes were used in the work (which must be distributed under Sections 1 and 2 above); and, if the work is an executable linked with the Library, with the complete machine-readable "work that uses the Library", as object code and/or source code, so that the user can modify the Library and then relink to produce a modified executable containing the modified Library. (It is understood that the user who changes the contents of definitions files in the Library will not necessarily be able to recompile the application to use the modified definitions.)

b) Use a suitable shared library mechanism for linking with the Library. A suitable mechanism is one that (1) uses at run time a copy of the library already present on the user's computer system, rather than copying library functions into the executable, and (2) will operate properly with a modified version of the library, if the user installs one, as long as the modified version is interface-compatible with the version that the work was made with.

c) Accompany the work with a written offer, valid for at least three years, to give the same user the materials specified in Subsection 6a, above, for a charge no more than the cost of performing this distribution.

d) If distribution of the work is made by offering access to copy from a designated place, offer equivalent access to copy the above specified materials from the same place.

e) Verify that the user has already received a copy of these materials or that you have already sent this user a copy.

For an executable, the required form of the "work that uses the Library" must include any data and utility programs needed for reproducing the executable from it. However, as a special exception, the materials to be distributed need not include anything that is normally distributed (in either source or binary form) with the major components (compiler, kernel, and so on) of the operating system on which the executable runs, unless that component itself accompanies the executable.

It may happen that this requirement contradicts the license restrictions of other proprietary libraries that do not normally accompany the operating system. Such a contradiction means you cannot use both them and the Library together in an executable that you distribute.

7. You may place library facilities that are a work based on the Library side-by-side in a single library together with other library facilities not covered by this License, and distribute such a combined library, provided that the separate distribution of the work based on the Library and of the other library facilities is otherwise permitted, and provided that you do these two things:

a) Accompany the combined library with a copy of the same work based on the Library, uncombined with any other library facilities. This must be distributed under the terms of the Sections above.

b) Give prominent notice with the combined library of the fact that part of it is a work based on the Library, and explaining where to find the accompanying uncombined form of the same work.

8. You may not copy, modify, sublicense, link with, or distribute the Library except as expressly provided under this License. Any attempt otherwise to copy, modify, sublicense, link with, or distribute the Library is void, and will automatically terminate your rights under this License. However, parties who have received copies, or rights, from you under this License will not have their licenses terminated so long as such parties remain in full compliance.

9. You are not required to accept this License, since you have not signed it. However, nothing else grants you permission to modify or distribute the Library or its derivative works. These actions are prohibited by law if you do not accept this License. Therefore, by modifying or distributing the Library (or any work based on the Library), you indicate your acceptance of this License to do so, and all its terms and conditions for copying, distributing or modifying the Library or works based on it.

10. Each time you redistribute the Library (or any work based on the Library), the recipient automatically receives a license from the original licensor to copy, distribute, link with or modify the Library subject to these terms and conditions. You may not impose any further restrictions on the recipients' exercise of the rights granted herein. You are not responsible for enforcing compliance by third parties with this License.

11. If, as a consequence of a court judgment or allegation of patent infringement or for any other reason (not limited to patent issues), conditions are imposed on you (whether by court order, agreement or otherwise) that contradict the conditions of this License, they do not excuse you from the conditions of this License. If you cannot distribute so as to satisfy simultaneously your obligations under this License and any other pertinent obligations, then as a consequence you may not distribute the Library at all. For example, if a patent license would not permit royalty-free redistribution of the Library by all those who receive copies directly or indirectly through you, then the only way you could satisfy both it and this License would be to refrain entirely from distribution of the Library.

If any portion of this section is held invalid or unenforceable under any particular circumstance, the balance of the section is intended to apply, and the section as a whole is intended to apply in other circumstances.

It is not the purpose of this section to induce you to infringe any patents or other property right claims or to contest validity of any such claims; this section has the sole purpose of protecting the integrity of the free software distribution system which is implemented by public license practices. Many people have made generous contributions to the wide range of software distributed through that system in reliance on consistent application of that system; it is up to the author/donor to decide if he or she is willing to distribute software through any other system and a licensee cannot impose that choice.

This section is intended to make thoroughly clear what is believed to be a consequence of the rest of this License.

12. If the distribution and/or use of the Library is restricted in certain countries either by patents or by copyrighted interfaces, the original copyright holder who places the Library under this License may add an explicit geographical distribution limitation excluding those countries, so that distribution is permitted only in or among countries not thus excluded. In such case, this License incorporates the limitation as if written in the body of this License.

13. The Free Software Foundation may publish revised and/or new versions of the Lesser General Public License from time to time. Such new versions will be similar in spirit to the present version, but may differ in detail to address new problems or concerns.

Each version is given a distinguishing version number. If the Library specifies a version number of this License which applies to it and "any later version", you have the option of following the terms and conditions either of that version or of any later version published by the Free Software Foundation. If the Library does not specify a license version number, you may choose any version ever published by the Free Software Foundation.

14. If you wish to incorporate parts of the Library into other free programs whose distribution conditions are incompatible with these, write to the author to ask for permission. For software which is copyrighted by the Free Software Foundation, write to the Free Software Foundation; we sometimes make exceptions for this. Our decision will be guided by the two goals of preserving the free status of all derivatives of our free software and of promoting the sharing and reuse of software generally.

NO WARRANTY

15. BECAUSE THE LIBRARY IS LICENSED FREE OF CHARGE, THERE IS NO WARRANTY FOR THE LIBRARY, TO THE EXTENT PERMITTED BY APPLICABLE LAW. EXCEPT WHEN OTHERWISE STATED IN WRITING THE COPYRIGHT HOLDERS AND/OR OTHER PARTIES PROVIDE THE LIBRARY "AS IS" WITHOUT WARRANTY OF ANY KIND, EITHER EXPRESSED OR IMPLIED, INCLUDING, BUT NOT LIMITED

TO, THE IMPLIED WARRANTIES OF MERCHANTABILITY AND FITNESS FOR A PARTICULAR PURPOSE. THE ENTIRE RISK AS TO THE QUALITY AND PERFORMANCE OF THE LIBRARY IS WITH YOU. SHOULD THE LIBRARY PROVE DEFECTIVE, YOU ASSUME THE COST OF ALL NECESSARY SERVICING, REPAIR OR CORRECTION.

16. IN NO EVENT UNLESS REQUIRED BY APPLICABLE LAW OR AGREED TO IN WRITING WILL ANY COPYRIGHT HOLDER, OR ANY OTHER PARTY WHO MAY MODIFY AND/OR REDISTRIBUTE THE LIBRARY AS PERMITTED ABOVE, BE LIABLE TO YOU FOR DAMAGES, INCLUDING ANY GENERAL, SPECIAL, INCIDENTAL OR CONSEQUENTIAL DAMAGES ARISING OUT OF THE USE OR INABILITY TO USE THE LIBRARY (INCLUDING BUT NOT LIMITED TO LOSS OF DATA OR DATA BEING RENDERED INACCURATE OR LOSSES SUSTAINED BY YOU OR THIRD PARTIES OR A FAILURE OF THE LIBRARY TO OPERATE WITH ANY OTHER SOFTWARE), EVEN IF SUCH HOLDER OR OTHER PARTY HAS BEEN ADVISED OF THE POSSIBILITY OF SUCH DAMAGES.

END OF TERMS AND CONDITIONS

How to Apply These Terms to Your New Libraries

If you develop a new library, and you want it to be of the greatest possible use to the public, we recommend making it free software that everyone can redistribute and change. You can do so by permitting redistribution under these terms (or, alternatively, under the terms of the ordinary General Public License).

To apply these terms, attach the following notices to the library. It is safest to attach them to the start of each source file to most effectively convey the exclusion of warranty; and each file should have at least the "copyright" line and a pointer to where the full notice is found.

one line to give the library's name and an idea of what it does.

Copyright (C) year name of author

This library is free software; you can redistribute it and/or modify it under the terms of the GNU Lesser General Public License as published by the Free Software Foundation; either version 2.1 of the License, or (at your option) any later version.

This library is distributed in the hope that it will be useful, but WITHOUT ANY WARRANTY; without even the implied warranty of MERCHANTABILITY or FITNESS FOR A PARTICULAR PURPOSE. See the GNU Lesser General Public License for more details.

You should have received a copy of the GNU Lesser General Public License along with this library; if not, write to the Free Software Foundation, Inc., 51 Franklin Street, Fifth Floor, Boston, MA 02110-1301 USA

Also add information on how to contact you by electronic and paper mail.

You should also get your employer (if you work as a programmer) or your school, if any, to sign a "copyright disclaimer" for the library, if necessary. Here is a sample; alter the names:

Yoyodyne, Inc., hereby disclaims all copyright interest in the library 'Frob' (a library for tweaking knobs) written by James Random Hacker.

signature of Ty Coon, 1 April 1990

Ty Coon, President of Vice

That's all there is to it!

GNU LESSER GENERAL PUBLIC LICENSE 3.0

- JasperReports Library - jasperreports (2000 - 2014, Jaspersoft Corporation)
- m-surveys (2013, Eklektix, Inc)

Version 3, 29 June 2007

Copyright (C) 2007 Free Software Foundation, Inc. <<http://fsf.org/>>

Everyone is permitted to copy and distribute verbatim copies of this license document, but changing it is not allowed.

This version of the GNU Lesser General Public License incorporates the terms and conditions of version 3 of the GNU General Public License, supplemented by the additional permissions listed below.

0. Additional Definitions.

As used herein, "this License" refers to version 3 of the GNU Lesser General Public License, and the "GNU GPL" refers to version 3 of the GNU General Public License.

"The Library" refers to a covered work governed by this License, other than an Application or a Combined Work as defined below.

An "Application" is any work that makes use of an interface provided by the Library, but which is not otherwise based on the Library. Defining a subclass of a class defined by the Library is deemed a mode of using an interface provided by the Library.

A "Combined Work" is a work produced by combining or linking an Application with the Library. The particular version of the Library with which the Combined Work was made is also called the "Linked Version".

The "Minimal Corresponding Source" for a Combined Work means the Corresponding Source for the Combined Work, excluding any source code for portions of the Combined Work that, considered in isolation, are based on the Application, and not on the Linked Version.

The "Corresponding Application Code" for a Combined Work means the object code and/or source code for the Application, including any data and utility programs needed for reproducing the Combined Work from the Application, but excluding the System Libraries of the Combined Work.

1. Exception to Section 3 of the GNU GPL.

You may convey a covered work under sections 3 and 4 of this License without being bound by section 3 of the GNU GPL.

2. Conveying Modified Versions.

If you modify a copy of the Library, and, in your modifications, a facility refers to a function or data to be supplied by an Application that uses the facility (other than as an argument passed when the facility is invoked), then you may convey a copy of the modified version:

a) under this License, provided that you make a good faith effort to ensure that, in the event an Application does not supply the function or data, the facility still operates, and performs whatever part of its purpose remains meaningful, or

b) under the GNU GPL, with none of the additional permissions of this License applicable to that copy.

3. Object Code Incorporating Material from Library Header Files.

The object code form of an Application may incorporate material from a header file that is part of the Library. You may convey such object code under terms of your choice, provided that, if the incorporated material is not limited to numerical parameters, data structure layouts and accessors, or small macros, inline functions and templates (ten or fewer lines in length), you do both of the following:

a) Give prominent notice with each copy of the object code that the Library is used in it and that the Library and its use are covered by this License.

b) Accompany the object code with a copy of the GNU GPL and this license document.

4. Combined Works.

You may convey a Combined Work under terms of your choice that, taken together, effectively do not restrict modification of the portions of the Library contained in the Combined Work and reverse engineering for debugging such modifications, if you also do each of the following:

a) Give prominent notice with each copy of the Combined Work that the Library is used in it and that the Library and its use are covered by this License.

b) Accompany the Combined Work with a copy of the GNU GPL and this license document.

c) For a Combined Work that displays copyright notices during execution, include the copyright notice for the Library among these notices, as well as a reference directing the user to the copies of the GNU GPL and this license document.

d) Do one of the following:

O) Convey the Minimal Corresponding Source under the terms of this License, and the Corresponding Application Code in a form suitable for, and under terms that permit, the user to recombine or relink the Application with a modified version of the Linked Version to produce a modified Combined Work, in the manner specified by section 6 of the GNU GPL for conveying Corresponding Source.

1) Use a suitable shared library mechanism for linking with the Library. A suitable mechanism is one that (a) uses at run time a copy of the Library already present on the user's computer system, and (b) will operate properly with a modified version of the Library that is interface-compatible with the Linked Version.

e) Provide Installation Information, but only if you would otherwise be required to provide such information under section 6 of the GNU GPL, and only to the extent that such information is necessary to install and execute a modified version of the Combined Work produced by recombining or relinking the Application with a modified version of the Linked Version. (If you use option 4d0, the Installation Information must accompany the Minimal Corresponding Source and Corresponding Application Code. If you use option 4d1, you must provide the Installation Information in the manner specified by section 6 of the GNU GPL for conveying Corresponding Source.)

5. Combined Libraries.

You may place library facilities that are a work based on the Library side by side in a single library together with other library facilities that are not Applications and are not covered by this License, and convey such a combined library under terms of your choice, if you do both of the following:

- a) Accompany the combined library with a copy of the same work based on the Library, uncombined with any other library facilities, conveyed under the terms of this License.
- b) Give prominent notice with the combined library that part of it is a work based on the Library, and explaining where to find the accompanying uncombined form of the same work.

6. Revised Versions of the GNU Lesser General Public License.

The Free Software Foundation may publish revised and/or new versions of the GNU Lesser General Public License from time to time. Such new versions will be similar in spirit to the present version, but may differ in detail to address new problems or concerns.

Each version is given a distinguishing version number. If the Library as you received it specifies that a certain numbered version of the GNU Lesser General Public License "or any later version" applies to it, you have the option of following the terms and conditions either of that published version or of any later version published by the Free Software Foundation. If the Library as you received it does not specify a version number of the GNU Lesser General Public License, you may choose any version of the GNU Lesser General Public License ever published by the Free Software Foundation.

If the Library as you received it specifies that a proxy can decide whether future versions of the GNU Lesser General Public License shall apply, that proxy's public statement of acceptance of any version is permanent authorization for you to choose that version for the Library.

LICENSE ISSUES

The OpenSSL toolkit stays under a dual license, i.e. both the conditions of the OpenSSL License and the original SSLeay license apply to the toolkit. See below for the actual license texts. Actually both licenses are BSD-style Open Source licenses. In case of any license issues related to OpenSSL please contact openssl-core@openssl.org.

OpenSSL License

Copyright (c) 1998-2008 The OpenSSL Project. All rights reserved.

Redistribution and use in source and binary forms, with or without modification, are permitted provided that the following conditions are met:

1. Redistributions of source code must retain the above copyright notice, this list of conditions and the following disclaimer.
2. Redistributions in binary form must reproduce the above copyright notice, this list of conditions and the following disclaimer in the documentation and/or other materials provided with the distribution.
3. All advertising materials mentioning features or use of this software must display the following acknowledgment: "This product includes software developed by the OpenSSL Project for use in the OpenSSL Toolkit. (<http://www.openssl.org/>)"
4. The names "OpenSSL Toolkit" and "OpenSSL Project" must not be used to endorse or promote products derived from this software without prior written permission. For written permission, please contact openssl-core@openssl.org.
5. Products derived from this software may not be called "OpenSSL" nor may "OpenSSL" appear in their names without prior written permission of the OpenSSL Project.
6. Redistributions of any form whatsoever must retain the following acknowledgment: "This product includes software developed by the OpenSSL Project for use in the OpenSSL Toolkit (<http://www.openssl.org/>)"

THIS SOFTWARE IS PROVIDED BY THE OpenSSL PROJECT "AS IS" AND ANY EXPRESSED OR IMPLIED WARRANTIES, INCLUDING, BUT NOT LIMITED TO, THE IMPLIED WARRANTIES OF MERCHANTABILITY AND FITNESS FOR A PARTICULAR PURPOSE ARE DISCLAIMED. IN NO EVENT SHALL THE OpenSSL PROJECT OR ITS CONTRIBUTORS BE LIABLE FOR ANY DIRECT, INDIRECT, INCIDENTAL, SPECIAL, EXEMPLARY, OR CONSEQUENTIAL DAMAGES (INCLUDING, BUT NOT LIMITED TO, PROCUREMENT OF SUBSTITUTE GOODS OR SERVICES; LOSS OF USE, DATA, OR PROFITS; OR BUSINESS INTERRUPTION) HOWEVER CAUSED AND ON ANY THEORY OF LIABILITY, WHETHER IN CONTRACT, STRICT LIABILITY, OR TORT (INCLUDING NEGLIGENCE OR OTHERWISE) ARISING IN ANY WAY OUT OF THE USE OF THIS SOFTWARE, EVEN IF ADVISED OF THE POSSIBILITY OF SUCH DAMAGE.

THIS SOFTWARE IS PROVIDED BY THE OpenSSL PROJECT "AS IS" AND ANY EXPRESSED OR IMPLIED WARRANTIES, INCLUDING, BUT NOT LIMITED TO, THE IMPLIED WARRANTIES OF MERCHANTABILITY AND FITNESS FOR A PARTICULAR PURPOSE ARE DISCLAIMED. IN NO EVENT SHALL THE OpenSSL PROJECT OR ITS CONTRIBUTORS BE LIABLE FOR ANY DIRECT, INDIRECT, INCIDENTAL, SPECIAL, EXEMPLARY, OR CONSEQUENTIAL DAMAGES (INCLUDING, BUT NOT LIMITED TO, PROCUREMENT OF SUBSTITUTE GOODS OR SERVICES; LOSS OF USE, DATA, OR PROFITS; OR BUSINESS INTERRUPTION) HOWEVER CAUSED AND ON ANY THEORY OF LIABILITY, WHETHER IN CONTRACT, STRICT LIABILITY, OR TORT (INCLUDING NEGLIGENCE OR OTHERWISE) ARISING IN ANY WAY OUT OF THE USE OF THIS SOFTWARE, EVEN IF ADVISED OF THE POSSIBILITY OF SUCH DAMAGE.

This product includes cryptographic software written by Eric Young (ey@cryptsoft.com). This product includes software written by Tim Hudson (tjh@cryptsoft.com).

Original SSLeay License

Copyright (C) 1995-1998 Eric Young (ey@cryptsoft.com)

All rights reserved.

This package is an SSL implementation written by Eric Young (ey@cryptsoft.com).

The implementation was written so as to conform with Netscapes SSL.

This library is free for commercial and non-commercial use as long as the following conditions are aheared to. The following conditions apply to all code found in this distribution, be it the RC4, RSA, lhash, DES, etc., code; not just the SSL code. The SSL documentation included with this distribution is covered by the same copyright terms except that the holder is Tim Hudson (tjh@cryptsoft.com). Copyright remains Eric Young's, and as such any Copyright notices in the code are not to be removed.

If this package is used in a product, Eric Young should be given attribution as the author of the parts of the library used.

This can be in the form of a textual message at program startup or in documentation (online or textual) provided with the package.

Redistribution and use in source and binary forms, with or without modification, are permitted provided that the following conditions are met:

1. Redistributions of source code must retain the copyright notice, this list of conditions and the following disclaimer.
2. Redistributions in binary form must reproduce the above copyright notice, this list of conditions and the following disclaimer in the documentation and/or other materials provided with the distribution.
3. All advertising materials mentioning features or use of this software must display the following acknowledgement: "This product includes cryptographic software written by Eric Young (ey@cryptsoft.com)" The word 'cryptographic' can be left out if the rouines from the library being used are not cryptographic related :-).
4. If you include any Windows specific code (or a derivative thereof) from the apps directory (application code) you must include an acknowledgement: "This product includes software written by Tim Hudson (tjh@cryptsoft.com)"

THIS SOFTWARE IS PROVIDED BY ERIC YOUNG "AS IS" AND ANY EXPRESS OR IMPLIED WARRANTIES, INCLUDING, BUT NOT LIMITED TO, THE IMPLIED WARRANTIES OF MERCHANTABILITY AND FITNESS FOR A PARTICULAR PURPOSE ARE DISCLAIMED. IN NO EVENT SHALL THE AUTHOR OR CONTRIBUTORS BE LIABLE FOR ANY DIRECT, INDIRECT, INCIDENTAL, SPECIAL, EXEMPLARY, OR CONSEQUENTIAL DAMAGES (INCLUDING, BUT NOT LIMITED TO, PROCUREMENT OF SUBSTITUTE GOODS OR SERVICES; LOSS OF USE, DATA, OR PROFITS; OR BUSINESS INTERRUPTION) HOWEVER CAUSED AND ON ANY THEORY OF LIABILITY, WHETHER IN CONTRACT, STRICT LIABILITY, OR TORT (INCLUDING NEGLIGENCE OR OTHERWISE) ARISING IN ANY WAY OUT OF THE USE OF THIS SOFTWARE, EVEN IF ADVISED OF THE POSSIBILITY OF SUCH DAMAGE.

The licence and distribution terms for any publically available version or derivative of this code cannot be changed. i.e. this code cannot simply be copied and put under another distribution licence [including the GNU Public Licence.]

XFree86 License 1.0

Version 1.0 of XFree86® Project License.

Copyright (C) 1994-2003 The XFree86® Project, Inc.

All Rights Reserved.

Permission is hereby granted, free of charge, to any person obtaining a copy of this software and associated documentation files (the "Software"), to deal in the Software without restriction, including without limitation the rights to use, copy, modify, merge, publish, distribute, sublicense, and/or sell copies of the Software, and to permit persons to whom the Software is furnished to do so, subject to the following conditions:

The above copyright notice and this permission notice shall be included in all copies or substantial portions of the Software.

THE SOFTWARE IS PROVIDED "AS IS", WITHOUT WARRANTY OF ANY KIND, EXPRESS OR IMPLIED, INCLUDING BUT NOT LIMITED TO THE WARRANTIES OF MERCHANTABILITY, FITNESS FOR A PARTICULAR PURPOSE AND NONINFRINGEMENT. IN NO EVENT SHALL THE XFREE86 PROJECT BE LIABLE FOR ANY CLAIM, DAMAGES OR OTHER LIABILITY, WHETHER IN AN ACTION OF CONTRACT, TORT OR OTHERWISE, ARISING FROM, OUT OF OR IN CONNECTION WITH THE SOFTWARE OR THE USE OR OTHER DEALINGS IN THE SOFTWARE.

Except as contained in this notice, the name of the XFree86 Project shall not be used in advertising or otherwise to promote the sale, use or other dealings in this Software without prior written authorization from the XFree86 Project.

Intel Software Development Products License

Copyright(C) 2000, Intel Corporation, all rights reserved.

Intel® Software Development Products – License Agreement

IMPORTANT - READ BEFORE COPYING, INSTALLING OR USING.

Do not copy, install, or use the Materials provided under this license agreement ("Agreement"), until you have carefully read the following terms and conditions.

By copying, installing, or otherwise using the Materials, you agree to be bound by the terms of this Agreement. If you do not agree to the terms of this Agreement, do not copy, install, or use the Materials.

End User License Agreement for the Intel(R) Software Development Products

1. LICENSE DEFINITIONS:

A. "Materials" are defined as the software, documentation, license key codes and other materials, including any updates and upgrade thereto, for the applicable Intel Software Development Product (which may be found at <http://www.intel.com/software/products/>), that are provided to you under this Agreement. Materials also include the Redistributables as defined below.

B. "Redistributables" are the files listed in the following text files that may be included in the Materials for the applicable Intel Software Development Product: `credist.txt`, `credist.txt`, `fredist.txt`, `redist.txt`.

C. "Cluster OpenMP Library", is comprised of the files listed in the "`credist.txt`" file specified above, is the Intel(R) Cluster OpenMP* Library add-on option to the Intel(R) C++ Compiler for Linux* and Intel(R) Fortran Compiler for Linux* products ("Intel Compiler for Linux"). The use of the Cluster OpenMP Library is conditioned on having a valid license from Intel for the Cluster OpenMP Library and for either Intel Compiler for Linux, and further is governed by the terms and conditions of the license agreement for applicable the Intel Compiler for Linux.

D. "Source Code" is defined as the Materials provided in human readable format, whether unmodified or modified by you.

E. "Sample Source" is the Source Code file(s) that: (i) demonstrate certain limited functions included in the binary libraries of the Intel(R) Integrated Performance Primitives ("Intel(R) IPPs"); (ii) are identified as Intel IPP sample source code; and (iii) are obtained separately from Intel after you register your copy of the Intel Integrated Performance Primitives product with Intel.

2. LICENSE GRANT:

A. Subject to all of the terms and conditions of this Agreement, Intel Corporation ("Intel") grants to you a non-exclusive, non-assignable, copyright license to use the Materials.

B. Subject to all of the terms and conditions of this Agreement, Intel grants to you a non-exclusive, non-assignable copyright license to modify the Materials, or any portions thereof, that are (i) provided in Source Code form or, (ii) are defined as Redistributables and are provided in text form.

C. Subject to all of the terms and conditions of this Agreement and any specific restrictions which may appear in the Redistributables text files, Intel grants to you a non-exclusive, non-assignable copyright license to distribute (except under an Evaluation License as specified below) the Redistributables, or any portions thereof, as part of the product or application you developed using the Materials. If such application is a software development library, then attribution, as specified in the product release notes of the corresponding Materials, shall be displayed prominently in that application's product documentation and on the application's product web site.

3. LICENSE RESTRICTIONS:

A. If you receive your first copy of the Materials electronically, and a second copy on media, then you may use the second copy only in accordance with your applicable license stated in this Agreement, or for backup or archival purposes. You may not provide the second copy to another user.

B. You may NOT: (i) use or copy the Materials except as provided in this Agreement; (ii) rent or lease the Materials to any third party; (iii) assign this Agreement or transfer the Materials without the express written consent of Intel; (iv) modify, adapt, or translate the Materials in whole or in part except as provided in this Agreement; (v) reverse engineer, decompile, or disassemble the Materials; (vi) attempt to modify or tamper with the normal function of a license manager that regulates usage of the Materials; (vii) distribute, sublicense or transfer the Source Code form of any components of the Materials, Redistributables and Sample Source and derivatives thereof to any third party except as

provided in this Agreement; or (viii) distribute Redistributables except as part of a larger program that adds significant primary functionality different from that of the Redistributables.

C. The scope and duration (time period) of your license depends on the type of license you obtained from Intel. The variety of license types are set forth below, which may not be available for all "Intel(R) Software Development Products" and therefore may not apply to the Materials. For more information on the types of licenses, please contact Intel or your sales representative.

i. **EVALUATION LICENSE** If you are using the Materials under the control of an Evaluation license, you as an individual may use the Materials only for internal evaluation purposes and only for the term of the evaluation time period, which is controlled by the license key code for the Materials. **NOTWITHSTANDING ANYTHING TO THE CONTRARY ELSEWHERE IN THIS AGREEMENT, YOU MAY NOT DISTRIBUTE ANY PORTION OF THE MATERIALS, AND THE APPLICATION AND/OR PRODUCT DEVELOPED BY YOU MAY ONLY BE USED FOR EVALUATION PURPOSES AND ONLY FOR THE TERM OF THE EVALUATION PERIOD.**

You may install copies of the Materials on an unlimited number of computers provided that you are the only individual using the Materials and only one copy of the Materials is in use at any one time. A separate license is required for each additional use and/or individual user in all other cases. Intel will provide you with a license code key that enables the Materials for an Evaluation license. If you are an entity, Intel grants you the right to designate one individual within your organization to have the sole right to use the Materials in the manner provided above.

ii. **NONCOMMERCIAL-USE LICENSE:** If you are using the Materials under the control of a Noncommercial-Use license, you as an individual may use the Materials only for non-business use where you receive no fee, salary or any other form of compensation. The Materials may not be used for any other purpose, whether "for profit" or "not for profit." Any work performed or produced as a result of use of the Materials cannot be performed or produced for the benefit of other parties for a fee, compensation or any other reimbursement or remuneration. You may install copies of the Materials on an unlimited number of computers provided that you are the only individual using the Materials and only one copy of the Materials is in use at any one time. A separate license is required for each additional use and/or individual user in all other cases. Intel will provide you with a license code key that enables the Materials for a Noncommercial-Use license. If you obtained a time-limited Noncommercial-Use license, the duration (time period) of your license and your ability to use the Materials is limited to the time period of the obtained license, which is controlled by the license key code for the Materials. If you are an entity, Intel grants you the right to designate one individual within your organization to have the sole right to use the Materials in the manner provided above.

iii. **SINGLE-USER LICENSE:** If you are using the Materials under the control of a Single-User license, you as an individual may install and use the Materials on an unlimited number of computers provided that you are the only individual using the Materials and only one copy of the Materials is in use at any one time. A separate license is required for each additional use and/or individual user in all other cases. Intel will provide you with a license code key that enables the Materials for a Single-User license. If you obtained a time-limited Single-User license, the duration (time period) of your license and your ability to use the Materials is limited to the time period of the obtained license, which is controlled by the license key code for the Materials.

If you are an entity, Intel grants you the right to designate one individual within your organization to have the sole right to use the Materials in the manner provided above.

iv. **NODE-LOCKED LICENSE:** If you are using the Materials under the control of a Node-Locked license, you may use the Materials only on a single designated computer by no more than the authorized number of concurrent users. A separate license is required for each additional concurrent user and/or computer in all other cases. Intel will provide you with a license code key that enables the Materials for a Node-Locked license up to the authorized number of concurrent users. If you obtained a time-limited Node-Locked license, the duration (time period) of your license and your ability to use the Materials is limited to the time period of the obtained license, which is controlled by the license key code for the Materials.

v. **FLOATING LICENSE:** If you are using the Materials under the control of a Floating license, you may (a) install the Materials on an unlimited number of computers that are connected to the designated network and (b) use the Material by no more than the authorized number of concurrent users. A separate license is required for each additional concurrent user and/or network on which the Materials are used. Intel will provide you with a license code key that enables the Materials for a Floating license up to the authorized number of concurrent users. If you obtained a time-limited Floating license, the duration (time period) of your license and your ability to use the Materials is limited to the time

period of the obtained license, which is controlled by the license key code for the Materials. Intel Library Floating License: If the Materials are the Intel(R) Math Kernel Library or the Intel(R) Integrated Performance Primitives Library or the Intel(R) Threading Building Blocks (either "Intel Library"), then the Intel Library is provided to you as an add-on option to either the Intel(R) C++ Compiler product or the Intel(R) Fortran Compiler product (either "Intel Compiler") for which you have a Floating license, and as such, in addition to the terms and conditions above, the Intel Library may only be used by the authorized concurrent users of that Intel Compiler Floating license.

vi. CLUSTER SYSTEM LICENSE: If you are using the Materials under the control of a Cluster System license, (a) you may install the Materials on an unlimited number of computers provided that all such computers are part of a single cluster system and (b) if you are an entity you must designate from within your organization individuals, up to and not exceeding the authorized number of users, to have the sole right to use the Materials, and you must limit the use of the Materials to only those designated individuals. A separate license is required for (c) each additional cluster system on which the Materials are used, and (d) each additional designated individual user exceeding the authorized number of users. Intel will provide you with a license code key that enables the Materials for a Cluster System license up to the authorized number of individual users/users.

If you obtained a time-limited Cluster System license, the duration (time period) of your license and your ability to use the Materials is limited to the time period of the obtained license, which is specified in the Materials and/or controlled by the license key code for the Materials.

D. DISTRIBUTION: Distribution of the Materials is also subject to the following limitations: You (i) shall be solely responsible to your customers for any update or support obligation or other liability which may arise from the distribution, (ii) shall not make any statement that your product is "certified", or that its performance is guaranteed, by Intel, (iii) shall not use Intel's name or trademarks to market your product without written permission, (iv) shall prohibit disassembly and reverse engineering, (v) shall not publish reviews of Materials designated as beta without written permission by Intel, and (vi) shall indemnify, hold harmless, and defend Intel and its suppliers from and against any claims or lawsuits, including attorney's fees, that arise or result from your distribution of any product.

E. Intel(R) Integrated Performance Primitives (Intel IPP). The following terms and conditions apply only to the Intel IPP.

i. Licensee's use or implementation of the Intel IPP Materials may require additional licenses, including but not limited to copyright and patent licenses from various entities. Should any such additional copyright, patent or other licenses be required, Licensee agrees to obtain any such licenses at Licensee's own expense. Licensee is solely responsible for obtaining any such licenses and the copyright licenses granted in herein are conditioned on Licensee obtaining such additional licenses.

ii. Notwithstanding anything herein to the contrary, a valid license to Intel IPP is a prerequisite to any license for Sample Source, and possession of Sample Source does not grant any license to Intel IPP (or any portion thereof). To access Sample

Source, you must first register your licensed copy of the Intel IPP with Intel. By downloading, installing or copying any Sample Source file, you agree to be bound by terms of this Agreement.

F. SOFTWARE TRANSFER: You may permanently transfer all of your rights under this Agreement only with Intel's prior written permission.

4. COPYRIGHT: Title to the Materials and all copies thereof remain with Intel or its suppliers. The Materials are copyrighted and are protected by United States copyright laws and international treaty provisions. You will not remove any copyright notice from the Materials. You agree to prevent any unauthorized copying of the Materials. Except as expressly provided herein, no license or right is granted to you directly or by implication, inducement, estoppel or otherwise, specifically Intel does not grant any express or implied right to you under Intel patents, copyrights, trademarks, or trade secret information.

5. NO WARRANTY AND LIMITED REPLACEMENT: THE MATERIALS AND INFORMATION ARE PROVIDED "AS IS" WITH NO WARRANTIES, EXPRESS OR IMPLIED, INCLUDING BUT NOT LIMITED TO ANY IMPLIED WARRANTY OF MERCHANTABILITY, FITNESS FOR A PARTICULAR PURPOSE, NON-INFRINGEMENT OF INTELLECTUAL PROPERTY RIGHTS, OR ANY WARRANTY OTHERWISE ARISING OUT OF ANY PROPOSAL, SPECIFICATION, OR SAMPLE. If the media on which the Materials are furnished are found to be defective in material or workmanship under normal use for a period of ninety (90) days from the date of receipt, Intel's entire liability and your exclusive remedy shall be the replacement of the media. This offer is void if the media defect results from accident, abuse, or misapplication.

6. LIMITATION OF LIABILITY: THE ABOVE REPLACEMENT PROVISION IS THE ONLY WARRANTY OF ANY KIND. INTEL OFFERS NO OTHER WARRANTY EITHER EXPRESS OR IMPLIED INCLUDING THOSE OF MERCHANTABILITY, NON-INFRINGEMENT OF THIRD-PARTY INTELLECTUAL PROPERTY OR FITNESS FOR A PARTICULAR PURPOSE. NEITHER INTEL NOR ITS SUPPLIERS SHALL BE LIABLE FOR ANY DAMAGES WHATSOEVER (INCLUDING, WITHOUT LIMITATION, DAMAGES FOR LOSS OF BUSINESS PROFITS, BUSINESS INTERRUPTION, LOSS OF BUSINESS INFORMATION, OR OTHER LOSS) ARISING OUT OF THE USE OF OR INABILITY TO USE THE SOFTWARE, EVEN IF INTEL HAS BEEN ADVISED OF THE POSSIBILITY OF SUCH DAMAGES. BECAUSE SOME JURISDICTIONS PROHIBIT THE EXCLUSION OR LIMITATION OF LIABILITY FOR CONSEQUENTIAL OR INCIDENTAL DAMAGES, THE ABOVE LIMITATION MAY NOT APPLY TO YOU.

7. UNAUTHORIZED USE: THE MATERIALS ARE NOT DESIGNED, INTENDED, OR AUTHORIZED FOR USE IN ANY TYPE OF SYSTEM OR APPLICATION IN WHICH THE FAILURE OF THE MATERIALS COULD CREATE A SITUATION WHERE PERSONAL INJURY OR DEATH MAY OCCUR (E.G. MEDICAL SYSTEMS, LIFE SUSTAINING OR LIFE SAVING SYSTEMS). Should the buyer purchase or use the Materials for any such unintended or unauthorized use, the buyer shall indemnify and hold Intel and its officers, subsidiaries and affiliates harmless against all claims, costs, damages, and expenses, and reasonable attorney fees arising out of, directly or indirectly, any claim of product liability, personal injury or death associated with such unintended or unauthorized use, even if such claim alleges that Intel was negligent regarding the design or manufacture of the part.

8. USER SUBMISSIONS: You agree that any material, information or other communication you transmit or post to an Intel website or provide to Intel under this Agreement will be considered non-confidential and non-proprietary ("Communications"). Intel will have no obligations with respect to the Communications. You agree that Intel and its designees will be free to copy, modify, create derivative works, publicly display, disclose, distribute, license and sublicense through multiple tiers of distribution and licensees, incorporate and otherwise use the Communications and all data, images, sounds, text, and other things embodied therein, including derivative works thereto, for any and all commercial or non-commercial purposes. You are prohibited from posting or transmitting to or from an Intel website or provide to Intel any unlawful, threatening, libelous, defamatory, obscene, pornographic, or other material that would violate any law.

9. TERMINATION OF THIS LICENSE: This Agreement becomes effective on the date you accept this Agreement and will continue until terminated as provided for in this Agreement. If you are using the Materials under the control of a time-limited license, for example an Evaluation License, this Agreement terminates without notice on the last day of the time period, which is controlled by the license key code for the Materials. Intel may terminate this license at any time if you are in breach of any of its terms and conditions. Upon termination, you will immediately return to Intel or destroy the Materials and all copies thereof.

10. U.S. GOVERNMENT RESTRICTED RIGHTS: The Materials are provided with "RESTRICTED RIGHTS". Use, duplication or disclosure by the Government is subject to restrictions set forth in FAR52.227-14 and DFAR252.227-7013 et seq. or its successor. Use of the Materials by the Government constitutes acknowledgment of Intel's rights in them.

11. APPLICABLE LAWS: Any claim arising under or relating to this Agreement shall be governed by the internal substantive laws of the State of Delaware, without regard to principles of conflict of laws. You agree that the terms of the United Nations Convention on Contracts for the Sale of Goods do not apply to this Agreement. You agree that your distribution and export/re-export of the Software and permitted modifications shall be in compliance with the laws, regulations, orders or other restrictions of applicable export laws.

12. THIRD PARTY PROGRAMS. The Materials may contain third party programs. The license terms with those third party programs apply to your use of them.

* Other names and brands may be claimed as the property of others

Microsoft Public License(Ms-PL)

Copyright(C)

- cfx (Microsoft Corporation)
- netsqlzman (2004, Armand du Plessis <armand@dotnet.org.za>)
- mooncodecs (2002, Mark Crichton <crichton@gimp.org>)

- Extended WPF Toolkit (2007-2013, Xceed Software Inc.)
- Altairis Web UI Toolkit (2006-2014, Microsoft)
- NumericalDataApplication (2006-2014, Microsoft)
- WPF Wizard Control (2006-2014, Microsoft)
- Latence (2006-2014, Microsoft)
- EasyTweet (2006-2014, Microsoft)

This license governs use of the accompanying software. If you use the software, you accept this license. If you do not accept the license, do not use the software.

1. Definitions

The terms "reproduce," "reproduction," "derivative works," and "distribution" have the same meaning here as under U.S. copyright law. A "contribution" is the original software, or any additions or changes to the software.

A "contributor" is any person that distributes its contribution under this license.

"Licensed patents" are a contributor's patent claims that read directly on its contribution.

2. Grant of Rights

(A) Copyright Grant- Subject to the terms of this license, including the license conditions and limitations in section 3, each contributor grants you a non-exclusive, worldwide, royalty-free copyright license to reproduce its contribution, prepare derivative works of its contribution, and distribute its contribution or any derivative works that you create.

(B) Patent Grant- Subject to the terms of this license, including the license conditions and limitations in section 3, each contributor grants you a non-exclusive, worldwide, royalty-free license under its licensed patents to make, have made, use, sell, offer for sale, import, and/or otherwise dispose of its contribution in the software or derivative works of the contribution in the software.

3. Conditions and Limitations

(A) No Trademark License- This license does not grant you rights to use any contributors' name, logo, or trademarks.

(B) If you bring a patent claim against any contributor over patents that you claim are infringed by the software, your patent license from such contributor to the software ends automatically.

(C) If you distribute any portion of the software, you must retain all copyright, patent, trademark, and attribution notices that are present in the software.

(D) If you distribute any portion of the software in source code form, you may do so only under this license by including a complete copy of this license with your distribution. If you distribute any portion of the software in compiled or object code form, you may only do so under a license that complies with this license.

(E) The software is licensed "as-is." You bear the risk of using it. The contributors give no express warranties, guarantees or conditions. You may have additional consumer rights under your local laws which this license cannot change. To the extent permitted under your local laws, the contributors exclude the implied warranties of merchantability, fitness for a particular purpose and non-infringement.

BSD 3-Clause License

- Open Computer Vision Library - opencv-win (2000-2008, Intel Corporation, all rights reserved. 2009, Willow Garage Inc., all rights reserved.)
- ASM Core (2000-2007, INRIA, France Telecom)
- d3 (2010-2014, Michael Bostock, All rights reserved.)
- DataTables (2008-2013 SpryMedia Ltd.)
- DataTablesSrc (2008-2013 SpryMedia Ltd.)
- jQuery::DataTables (2008-2012, Allan Jardine, all rights reserved.)
- MvcDataTables.NET (2009-2012, Allan Jardine, all rights reserved.)
- Paul Johnson's JavaScript Message Digest Hash Function Library (2000 - 2002, Paul Johnston)

The following is a BSD 3-Clause ("BSD New" or "BSD Simplified") license template. To generate your own license, change the values of OWNER, ORGANIZATION and YEAR from their original values as given here, and substitute your own.

Note: You may omit clause 3 and still be OSD-conformant. Despite its colloquial name "BSD New", this is not the newest version of the BSD license; it was followed by the even newer BSD-2-Clause version, sometimes known as the "Simplified BSD License". On January 9th, 2008 the OSI Board approved BSD-2-Clause, which is used by FreeBSD and others. It omits the final "no-endorsement" clause and is thus roughly equivalent to the MIT License.

Historical Background: The original license used on BSD Unix had four clauses. The advertising clause (the third of four clauses) required you to acknowledge use of U.C. Berkeley code in your advertising of any product using that code. It was officially rescinded by the Director of the Office of Technology Licensing of the University of California on July 22nd, 1999. He states that clause 3 is "hereby deleted in its entirety." The four clause license has not been approved by OSI. The license below does not contain the advertising clause.

This prelude is not part of the license.

<OWNER> = Regents of the University of California

<ORGANIZATION> = University of California, Berkeley

<YEAR> = 1998

In the original BSD license, the occurrence of "copyright holder" in the 3rd clause read "ORGANIZATION", placeholder for "University of California". In the original BSD license, both occurrences of the phrase "COPYRIGHT HOLDERS AND CONTRIBUTORS" in the disclaimer read "REGENTS AND CONTRIBUTORS".

Here is the license template:

Copyright (c) <YEAR>, <OWNER>

All rights reserved.

Redistribution and use in source and binary forms, with or without modification, are permitted provided that the following conditions are met:

1. Redistributions of source code must retain the above copyright notice, this list of conditions and the following disclaimer.
2. Redistributions in binary form must reproduce the above copyright notice, this list of conditions and the following disclaimer in the documentation and/or other materials provided with the distribution.
3. Neither the name of the copyright holder nor the names of its contributors may be used to endorse or promote products derived from this software without specific prior written permission.

THIS SOFTWARE IS PROVIDED BY THE COPYRIGHT HOLDERS AND CONTRIBUTORS "AS IS" AND ANY EXPRESS OR IMPLIED WARRANTIES, INCLUDING, BUT NOT LIMITED TO, THE IMPLIED WARRANTIES OF MERCHANTABILITY AND FITNESS FOR A PARTICULAR PURPOSE ARE DISCLAIMED. IN NO EVENT SHALL THE COPYRIGHT HOLDER OR CONTRIBUTORS BE LIABLE FOR ANY DIRECT, INDIRECT, INCIDENTAL, SPECIAL, EXEMPLARY, OR CONSEQUENTIAL DAMAGES (INCLUDING, BUT NOT LIMITED TO, PROCUREMENT OF SUBSTITUTE GOODS OR SERVICES; LOSS OF USE, DATA, OR PROFITS; OR BUSINESS INTERRUPTION) HOWEVER CAUSED AND ON ANY THEORY OF LIABILITY, WHETHER IN CONTRACT, STRICT LIABILITY, OR TORT (INCLUDING NEGLIGENCE OR OTHERWISE) ARISING IN ANY WAY OUT OF THE USE OF THIS SOFTWARE, EVEN IF ADVISED OF THE POSSIBILITY OF SUCH DAMAGE.

Oracle Binary Code JRE and JDK 7 License

Copyright (C) IBM Corporation 2005, 2010. All Rights Reserved.

Oracle Binary Code License Agreement for the Java SE Platform Products

ORACLE AMERICA, INC. ("ORACLE"), FOR AND ON BEHALF OF ITSELF AND ITS SUBSIDIARIES AND AFFILIATES UNDER COMMON CONTROL, IS WILLING TO LICENSE THE SOFTWARE TO YOU ONLY UPON THE CONDITION THAT YOU ACCEPT ALL OF THE TERMS CONTAINED IN THIS BINARY CODE LICENSE AGREEMENT AND SUPPLEMENTAL LICENSE TERMS (COLLECTIVELY "AGREEMENT"). PLEASE READ THE AGREEMENT CAREFULLY. BY SELECTING THE "ACCEPT LICENSE AGREEMENT" (OR THE EQUIVALENT) BUTTON AND/OR BY USING THE SOFTWARE YOU ACKNOWLEDGE THAT YOU HAVE READ THE TERMS AND AGREE TO THEM. IF YOU ARE AGREEING TO THESE TERMS ON BEHALF OF A COMPANY OR OTHER LEGAL ENTITY, YOU REPRESENT THAT YOU HAVE THE LEGAL AUTHORITY TO BIND THE LEGAL ENTITY TO THESE TERMS. IF YOU DO NOT HAVE SUCH AUTHORITY, OR IF YOU DO NOT WISH TO BE BOUND BY THE TERMS, THEN SELECT THE "DECLINE LICENSE AGREEMENT" (OR THE EQUIVALENT) BUTTON AND YOU MUST NOT USE THE SOFTWARE ON THIS SITE OR ANY OTHER MEDIA ON WHICH THE SOFTWARE IS CONTAINED.

1. DEFINITIONS.

"Software" means the Java SE Platform Products in binary form that you selected for download, install or use from Oracle or its authorized licensees, any other machine readable materials (including, but not limited to, libraries, source files, header files, and data files), any updates or error corrections provided by Oracle, and any user manuals, programming guides and other documentation provided to you by Oracle under this Agreement.

"General Purpose Desktop Computers and Servers" means computers, including desktop and laptop computers, or servers, used for general computing functions under end user control (such as but not specifically limited to email, general purpose Internet browsing, and office suite productivity tools). The use of Software in systems and solutions that provide dedicated functionality (other than as mentioned above) or designed for use in embedded or function-specific software applications, for example but not limited to: Software embedded in or bundled with industrial control systems, wireless mobile telephones, wireless handheld devices, netbooks, kiosks, TV/STB, Blu-ray Disc devices, telematics and network control switching equipment, printers and storage management systems, and other related systems are excluded from this definition and not licensed under this Agreement.

"Programs" means Java technology applets and applications intended to run on the Java Platform, Standard Edition platform on Java-enabled General Purpose Desktop Computers and Servers.

"Commercial Features" means those features identified in Table 1-1 (Commercial Features In Java SE Product Editions) of the Software documentation accessible at <http://www.oracle.com/technetwork/java/javase/documentation/index.html>.

"README File" means the README file for the Software accessible at <http://www.oracle.com/technetwork/java/javase/terms/readme/index.html>.

2. LICENSE TO USE. Subject to the terms and conditions of this Agreement including, but not limited to, the Java Technology Restrictions of the Supplemental License Terms, Oracle grants you a non-exclusive, non-transferable, limited license without license fees to reproduce and use internally the Software complete and unmodified for the sole purpose of running Programs. THE LICENSE SET FORTH IN THIS SECTION 2 DOES NOT EXTEND TO THE COMMERCIAL FEATURES. YOUR RIGHTS AND OBLIGATIONS RELATED TO THE COMMERCIAL FEATURES ARE AS SET FORTH IN THE SUPPLEMENTAL TERMS ALONG WITH ADDITIONAL LICENSES FOR DEVELOPERS AND PUBLISHERS.

3. RESTRICTIONS. Software is copyrighted. Title to Software and all associated intellectual property rights is retained by Oracle and/or its licensors. Unless enforcement is prohibited by applicable law, you may not modify, decompile, or reverse engineer Software. You acknowledge that the Software is developed for general use in a variety of information management applications; it is not developed or intended for use in any inherently dangerous applications, including applications that may create a risk of personal injury. If you use the Software in dangerous applications, then you shall be responsible to take all appropriate fail-safe, backup, redundancy, and other measures to ensure its safe use. Oracle disclaims any express or implied warranty of fitness for such uses. No right, title or interest in or to any trademark, service mark, logo or trade name of Oracle or its licensors is granted under this Agreement. Additional restrictions for developers and/or publishers licenses are set forth in the Supplemental License Terms.

4. DISCLAIMER OF WARRANTY. THE SOFTWARE IS PROVIDED "AS IS" WITHOUT WARRANTY OF ANY KIND. ORACLE FURTHER DISCLAIMS ALL WARRANTIES, EXPRESS AND IMPLIED, INCLUDING WITHOUT LIMITATION, ANY IMPLIED WARRANTIES OF MERCHANTABILITY, FITNESS FOR A PARTICULAR PURPOSE OR NONINFRINGEMENT.

5. LIMITATION OF LIABILITY. IN NO EVENT SHALL ORACLE BE LIABLE FOR ANY INDIRECT, INCIDENTAL, SPECIAL, PUNITIVE OR CONSEQUENTIAL DAMAGES, OR DAMAGES FOR LOSS OF PROFITS, REVENUE, DATA OR DATA USE, INCURRED BY YOU OR ANY THIRD PARTY, WHETHER IN AN ACTION IN CONTRACT OR TORT, EVEN IF ORACLE HAS BEEN ADVISED OF THE POSSIBILITY OF SUCH DAMAGES. ORACLE'S ENTIRE LIABILITY FOR DAMAGES HEREUNDER SHALL IN NO EVENT EXCEED ONE THOUSAND DOLLARS (U.S. \$1,000).

6. TERMINATION. This Agreement is effective until terminated. You may terminate this Agreement at any time by destroying all copies of Software. This Agreement will terminate immediately without notice from Oracle if you fail to comply with any provision of this Agreement. Either party may terminate this Agreement immediately should any Software become, or in either party's opinion be likely to become, the subject of a claim of infringement of any intellectual property right. Upon termination, you must destroy all copies of Software.

7. EXPORT REGULATIONS. You agree that U.S. export control laws and other applicable export and import laws govern your use of the Software, including technical data; additional information can be found on Oracle's Global Trade Compliance web site (<http://www.oracle.com/products/export>). You agree that neither the Software nor any direct product thereof will be exported, directly, or indirectly, in violation of these laws, or will be used for any purpose prohibited by these laws including, without limitation, nuclear, chemical, or biological weapons proliferation.

8. TRADEMARKS AND LOGOS. You acknowledge and agree as between you and Oracle that Oracle owns the ORACLE and JAVA trademarks and all ORACLE- and JAVA-related trademarks, service marks, logos and other brand designations ("Oracle Marks"), and you agree to comply with the Third Party Usage Guidelines for Oracle Trademarks currently located at <http://www.oracle.com/us/legal/third-party-trademarks/index.html>. Any use you make of the Oracle Marks inures to Oracle's benefit.

9. U.S. GOVERNMENT LICENSE RIGHTS. If Software is being acquired by or on behalf of the U.S. Government or by a U.S. Government prime contractor or subcontractor (at any tier), then the Government's rights in Software and accompanying documentation shall be only those set forth in this Agreement.

10. GOVERNING LAW. This agreement is governed by the substantive and procedural laws of California. You and Oracle agree to submit to the exclusive jurisdiction of, and venue in, the courts of San Francisco, or Santa Clara counties in California in any dispute arising out of or relating to this agreement.

11. SEVERABILITY. If any provision of this Agreement is held to be unenforceable, this Agreement will remain in effect with the provision omitted, unless omission would frustrate the intent of the parties, in which case this Agreement will immediately terminate.

12. INTEGRATION. This Agreement is the entire agreement between you and Oracle relating to its subject matter. It supersedes all prior or contemporaneous oral or written communications, proposals, representations and warranties and prevails over any conflicting or additional terms of any quote, order, acknowledgment, or other communication between the parties relating to its subject matter during the term of this Agreement. No modification of this Agreement will be binding, unless in writing and signed by an authorized representative of each party.

SUPPLEMENTAL LICENSE TERMS

These Supplemental License Terms add to or modify the terms of the Binary Code License Agreement. Capitalized terms not defined in these Supplemental Terms shall have the same meanings ascribed to them in the Binary Code License Agreement. These Supplemental Terms shall supersede any inconsistent or conflicting terms in the Binary Code License Agreement, or in any license contained within the Software.

A. COMMERCIAL FEATURES. You may not use the Commercial Features for running Programs, Java applets or applications in your internal business operations or for any commercial or production purpose, or for any purpose other than as set forth in Sections B, C, D and E of these Supplemental Terms. If you want to use the Commercial Features for any purpose other than as permitted in this Agreement, you must obtain a separate license from Oracle.

B. SOFTWARE INTERNAL USE FOR DEVELOPMENT LICENSE GRANT. Subject to the terms and conditions of this Agreement and restrictions and exceptions set forth in the README File incorporated herein by reference, including, but not limited to the Java Technology Restrictions of these Supplemental Terms, Oracle grants you a non-exclusive, non-transferable, limited license without fees to reproduce internally and use internally the Software complete and unmodified for the purpose of designing, developing, and testing your Programs.

C. LICENSE TO DISTRIBUTE SOFTWARE. Subject to the terms and conditions of this Agreement and restrictions and exceptions set forth in the README File, including, but not limited to the Java Technology Restrictions of these Supplemental Terms, Oracle grants you a non-exclusive, non-transferable, limited license without fees to reproduce and distribute the Software, provided that

i. you distribute the Software complete and unmodified and only bundled as part of, and for the sole purpose of running, your Programs,

ii. the Programs add significant and primary functionality to the Software,

iii. you do not distribute additional software intended to replace any component(s) of the Software,

iv. you do not remove or alter any proprietary legends or notices contained in the Software,

v. you only distribute the Software subject to a license agreement that:

a. is a complete, unmodified reproduction of this Agreement; or
b. protects Oracle's interests consistent with the terms contained in this Agreement and that includes the notice set forth in Section G, and
vi. you agree to defend and indemnify Oracle and its licensors from and against any damages, costs, liabilities, settlement amounts and/or expenses (including attorneys' fees) incurred in connection with any claim, lawsuit or action by any third party that arises or results from the use or distribution of any and all Programs and/or Software.

D. LICENSE TO DISTRIBUTE REDISTRIBUTABLES. Subject to the terms and conditions of this Agreement and restrictions and exceptions set forth in the README File, including but not limited to the Java Technology Restrictions of these Supplemental Terms, Oracle grants you a non-exclusive, non-transferable, limited license without fees to reproduce and distribute those files specifically identified as redistributable in the README File ("Redistributables") provided that:

- i. you distribute the Redistributables complete and unmodified, and only bundled as part of Programs,
- ii. the Programs add significant and primary functionality to the Redistributables,
- iii. you do not distribute additional software intended to supersede any component(s) of the Redistributables (unless otherwise specified in the applicable README File),
- iv. you do not remove or alter any proprietary legends or notices contained in or on the Redistributables,
- v. you only distribute the Redistributables pursuant to a license agreement that: a. is a complete, unmodified reproduction of this Agreement; or
- b. protects Oracle's interests consistent with the terms contained in the Agreement and includes the notice set forth in Section G,
- vi. you agree to defend and indemnify Oracle and its licensors from and against any damages, costs, liabilities, settlement amounts and/or expenses (including attorneys' fees) incurred in connection with any claim, lawsuit or action by any third party that arises or results from the use or distribution of any and all Programs and/or Software.

E. DISTRIBUTION BY PUBLISHERS. This section pertains to your distribution of the Java™ SE Development Kit Software with your printed book or magazine (as those terms are commonly used in the industry) relating to Java technology ("Publication"). Subject to and conditioned upon your compliance with the restrictions and obligations contained in the Agreement, Oracle hereby grants to you a non-exclusive, nontransferable limited right to reproduce complete and unmodified copies of the Software on electronic media (the "Media") for the sole purpose of inclusion and distribution with your Publication(s), subject to the following terms:

- i. You may not distribute the Software on a stand-alone basis; it must be distributed with your Publication(s);
- ii. You are responsible for downloading the Software from the applicable Oracle web site;
- iii. You must refer to the Software as Java™ SE Development Kit;
- iv. The Software must be reproduced in its entirety and without any modification whatsoever (including with respect to all proprietary notices) and distributed with your Publication subject to a license agreement that is a complete, unmodified reproduction of this Agreement;
- v. The Media label shall include the following information: Copyright 2011, Oracle America, Inc. All rights reserved. Use is subject to license terms. ORACLE and JAVA trademarks and all ORACLE- and JAVA-related trademarks, service marks, logos and other brand designations are trademarks or registered trademarks of Oracle in the U.S. and other countries. This information must be placed on the Media label in such a manner as to only apply to the Oracle Software;
- vi. You must clearly identify the Software as Oracle's product on the Media holder or Media label, and you may not state or imply that Oracle is responsible for any third-party software contained on the Media;
- vii. You may not include any third party software on the Media which is intended to be a replacement or substitute for the Software;
- viii. You agree to defend and indemnify Oracle and its licensors from and against any damages, costs, liabilities, settlement amounts and/or expenses (including attorneys' fees) incurred in connection with any claim, lawsuit or action by any third party that arises or results from the use or distribution of the Software and/or the Publication; ; and
- ix. You shall provide Oracle with a written notice for each Publication; such notice shall include the following information: (1) title of Publication, (2) author(s), (3) date of Publication, and (4) ISBN or ISSN numbers. Such notice shall be sent to Oracle America, Inc., 500 Oracle Parkway, Redwood Shores, California 94065 U.S.A , Attention: General Counsel.

F. JAVA TECHNOLOGY RESTRICTIONS. You may not create, modify, or change the behavior of, or authorize your licensees to create, modify, or change the behavior of, classes, interfaces, or subpackages that are in any way identified as "java", "javax", "sun", "oracle" or similar convention as specified by Oracle in any naming convention designation.

G. COMMERCIAL FEATURES NOTICE. For purpose of complying with Supplemental Term Section C.(v)(b) and D.(v)(b), your license agreement shall include the following notice, where the notice is displayed in a manner that anyone using the Software will see the notice:

Use of the Commercial Features for any commercial or production purpose requires a separate license from Oracle. "Commercial Features" means those features identified Table 1-1 (Commercial Features In Java SE Product Editions) of the Software documentation accessible at <http://www.oracle.com/technetwork/java/javase/documentation/index.html>

H. SOURCE CODE. Software may contain source code that, unless expressly licensed for other purposes, is provided solely for reference purposes pursuant to the terms of this Agreement. Source code may not be redistributed unless expressly provided for in this Agreement.

I. THIRD PARTY CODE. Additional copyright notices and license terms applicable to portions of the Software are set forth in the THIRDPARTYLICENSEREADME file accessible at <http://www.oracle.com/technetwork/java/javase/documentation/index.html>. In addition to any terms and conditions of any third party opensource/freeware license identified in the THIRDPARTYLICENSEREADME file, the disclaimer of warranty and limitation of liability provisions in paragraphs 4 and 5 of the Binary Code License Agreement shall apply to all Software in this distribution.

J. TERMINATION FOR INFRINGEMENT. Either party may terminate this Agreement immediately should any Software become, or in either party's opinion be likely to become, the subject of a claim of infringement of any intellectual property right.

K. INSTALLATION AND AUTO-UPDATE. The Software's installation and auto-update processes transmit a limited amount of data to Oracle (or its service provider) about those specific processes to help Oracle understand and optimize them. Oracle does not associate the data with personally identifiable information. You can find more information about the data Oracle collects as a result of your Software download at <http://www.oracle.com/technetwork/java/javase/documentation/index.html>.

For inquiries please contact: Oracle America, Inc., 500 Oracle Parkway, Redwood Shores, California 94065, USA.

Last updated May 17, 2011

BSD 2-Clause License

Copyright (C)

- morris.js (2012-2014, Ollly Smith All rights reserved.)
- Leaflet (2010-2013, Vladimir Agafonkin, CloudMade)

Redistribution and use in source and binary forms, with or without modification, are permitted provided that the following conditions are met:

1. Redistributions of source code must retain the above copyright notice, this list of conditions and the following disclaimer.
2. Redistributions in binary form must reproduce the above copyright notice, this list of conditions and the following disclaimer in the documentation and/or other materials provided with the distribution.

THIS SOFTWARE IS PROVIDED BY THE AUTHOR "AS IS" AND ANY EXPRESS OR IMPLIED WARRANTIES, INCLUDING, BUT NOT LIMITED TO, THE IMPLIED WARRANTIES OF MERCHANTABILITY AND FITNESS FOR A PARTICULAR PURPOSE ARE DISCLAIMED. IN NO EVENT SHALL THE AUTHOR BE LIABLE FOR ANY DIRECT, INDIRECT, INCIDENTAL, SPECIAL, EXEMPLARY, OR CONSEQUENTIAL DAMAGES (INCLUDING, BUT NOT LIMITED TO, PROCUREMENT OF SUBSTITUTE GOODS OR SERVICES; LOSS OF USE, DATA, OR PROFITS; OR BUSINESS INTERRUPTION) HOWEVER CAUSED AND ON ANY THEORY OF LIABILITY, WHETHER IN CONTRACT, STRICT LIABILITY, OR TORT (INCLUDING NEGLIGENCE OR OTHERWISE) ARISING IN ANY WAY OUT OF THE USE OF THIS SOFTWARE, EVEN IF ADVISED OF THE POSSIBILITY OF SUCH DAMAGE.

Creative Commons Attribution 2.0 UK License

Creative Commons Attribution 2.0 England and Wales

CREATIVE COMMONS CORPORATION IS NOT A LAW FIRM AND DOES NOT PROVIDE LEGAL SERVICES. DISTRIBUTION OF THIS LICENSE DOES NOT CREATE AN ATTORNEY-CLIENT RELATIONSHIP. CREATIVE COMMONS PROVIDES THIS INFORMATION ON AN "AS-IS" BASIS. CREATIVE COMMONS MAKES NO WARRANTIES REGARDING THE INFORMATION PROVIDED, AND DISCLAIMS LIABILITY FOR DAMAGES RESULTING FROM ITS USE.

Licence

THE WORK (AS DEFINED BELOW) IS PROVIDED UNDER THE TERMS OF THIS CREATIVE COMMONS PUBLIC LICENCE ("CCPL" OR "LICENCE"). THE WORK IS PROTECTED BY COPYRIGHT AND/OR OTHER APPLICABLE LAW. ANY USE OF THE WORK OTHER THAN AS AUTHORIZED UNDER THIS LICENCE OR COPYRIGHT LAW IS PROHIBITED. BY EXERCISING ANY RIGHTS TO THE WORK PROVIDED HERE, YOU ACCEPT AND AGREE TO BE BOUND BY THE TERMS OF THIS LICENCE. THE LICENSOR GRANTS YOU THE RIGHTS CONTAINED HERE IN CONSIDERATION OF YOUR ACCEPTANCE OF SUCH TERMS AND CONDITIONS.

This Creative Commons England and Wales Public Licence enables You (all capitalised terms defined below) to view, edit, modify, translate and distribute Works worldwide, provided that You credit the Original Author.

'The Licensor' [one or more legally recognised persons or entities offering the Work under the terms and conditions of this Licence]

and

'You'

agree as follows:

1. Definitions

a. "Attribution" means acknowledging all the parties who have contributed to and have rights in the Work, Derivative Work or Collective Work under this Licence.

b. "Collective Work" means the Work in its entirety in unmodified form along with a number of other separate and independent works, assembled into a collective whole.

c. "Derivative Work" means any work created by the editing, modification, adaptation or translation of the Work in any media (however a work that constitutes a Collective Work will not be considered a Derivative Work for the purpose of this Licence). For the avoidance of doubt, where the Work is a musical composition or sound recording, the synchronization of the Work in timed-relation with a moving image ("synching") will be considered a Derivative Work for the purpose of this Licence.

d. "Licence" means this Creative Commons England and Wales Public Licence agreement.

e. "Original Author" means the individual (or entity) who created the Work.

f. "Work" means the work protected by copyright which is offered under the terms of this Licence.

g. For the purpose of this Licence, when not inconsistent with the context, words in the singular number include the plural number.

2. Licence Terms

2.1 The Licensor hereby grants to You a worldwide, royalty-free, non-exclusive, Licence for use and for the duration of copyright in the Work.

You may:

- copy the Work;
- create one or more Derivative Works;
- incorporate the Work into one or more Collective Works;
- copy Derivative Works or the Work as incorporated in any Collective Work; and
- publish, distribute, archive, perform or otherwise disseminate the Work, Derivative Works or the Work as incorporated in any Collective Work, to the public in any material form in any media whether now known or hereafter created.

HOWEVER,

You must not:

- impose any terms on the use to be made of the Work, the Derivative Work or the Work as incorporated in a Collective Work that alter or restrict the terms of this Licence or any rights granted under it or has the effect or intent of restricting the ability to exercise those rights;
- impose any digital rights management technology on the Work, the Derivative Work or the Work as incorporated in a Collective Work that alters or restricts the terms of this Licence or any rights granted under it or has the effect or intent of restricting the ability to exercise those rights;
- sublicense the Work;
- subject the Work to any derogatory treatment as defined in the Copyright, Designs and Patents Act 1988.

FINALLY,

You must:

- make reference to this Licence (by Uniform Resource Identifier (URI), spoken word or as appropriate to the media used) on all copies of the Work and Derivative Works and Collective Works published, distributed, performed or otherwise disseminated or made available to the public by You;
- recognise the Licensor's / Original Author's right of attribution in any Work, Derivative Work and Collective Work that You publish, distribute, perform or otherwise disseminate to the public and ensure that You credit the Licensor / Original Author as appropriate to the media used; and
- to the extent reasonably practicable, keep intact all notices that refer to this Licence, in particular the URI, if any, that the Licensor specifies to be associated with the Work, unless such URI does not refer to the copyright notice or licensing information for the Work.

Additional Provisions for third parties making use of the Work

2.2. Further licence from the Licensor

Each time You publish, distribute, perform or otherwise disseminate

- the Work; or
- any Derivative Work; or
- the Work as incorporated in a Collective Work

the Licensor agrees to offer to the relevant third party making use of the Work (in any of the alternatives set out above) a licence to use the Work on the same terms and conditions as granted to You hereunder.

2.3. This Licence does not affect any rights that the User may have under any applicable law, including fair use, fair dealing or any other legally recognised limitation or exception to copyright infringement.

2.4. All rights not expressly granted by the Licensor are hereby reserved, including but not limited to, the exclusive right to collect, whether individually or via a licensing body, such as a collecting society, royalties for any use of the Work.

3. Warranties and Disclaimer

Except as required by law, the Work or any Derivative Work is licensed by the Licensor on an "as is" and "as available" basis and without any warranty of any kind, either express or implied.

4. Limit of Liability

Subject to any liability which may not be excluded or limited by law the Licensor shall not be liable and hereby expressly excludes all liability for loss or damage howsoever and whenever caused to You.

5. Termination

The rights granted to You under this Licence shall terminate automatically upon any breach by You of the terms of this Licence. Individuals or entities who have received Derivative Works or Collective Works from You under this Licence, however, will not have their Licences terminated provided such individuals or entities remain in full compliance with those Licences.

6. General

6.1. The validity or enforceability of the remaining terms of this agreement is not affected by the holding of any provision of it to be invalid or unenforceable.

6.2. This Licence constitutes the entire Licence Agreement between the parties with respect to the Work licensed here. There are no understandings, agreements or representations with respect to the Work not specified here. The Licensor shall not be bound by any additional provisions that may appear in any communication in any form.

6.3. A person who is not a party to this Licence shall have no rights under the Contracts (Rights of Third Parties) Act 1999 to enforce any of its terms.

6.4. This Licence shall be governed by the law of England and Wales and the parties irrevocably submit to the exclusive jurisdiction of the Courts of England and Wales.

7. On the role of Creative Commons

7.1. Neither the Licensor nor the User may use the Creative Commons logo except to indicate that the Work is licensed under a Creative Commons Licence. Any permitted use has to be in compliance with the Creative Commons trade mark usage guidelines at the time of use of the Creative Commons trade mark. These guidelines may be found on the Creative Commons website or be otherwise available upon request from time to time.

7.2. Creative Commons Corporation does not profit financially from its role in providing this Licence and will not investigate the claims of any Licensor or user of the Licence.

7.3. One of the conditions that Creative Commons Corporation requires of the Licensor and You is an acknowledgement of its limited role and agreement by all who use the Licence that the Corporation is not responsible to anyone for the statements and actions of You or the Licensor or anyone else attempting to use or using this Licence.

7.4. Creative Commons Corporation is not a party to this Licence, and makes no warranty whatsoever in connection to the Work or in connection to the Licence, and in all events is not liable for any loss or damage resulting from the Licensor's or Your reliance on this Licence or on its enforceability.

7.5. USE OF THIS LICENCE MEANS THAT YOU AND THE LICENSOR EACH ACCEPTS THESE CONDITIONS IN SECTION 7.1, 7.2, 7.3, 7.4 AND EACH ACKNOWLEDGES CREATIVE COMMONS CORPORATION'S VERY LIMITED ROLE AS A FACILITATOR OF THE LICENCE FROM THE LICENSOR TO YOU.

Creative Commons is not a party to this Licence, and makes no warranty whatsoever in connection with the Work. Creative Commons will not be liable to You or any party on any legal theory for any damages whatsoever, including without limitation any general, special, incidental or consequential damages arising in connection to this licence. Notwithstanding the foregoing two (2) sentences, if Creative Commons has expressly identified itself as the Licensor hereunder, it shall have all rights and obligations of Licensor.

Except for the limited purpose of indicating to the public that the Work is licensed under the CCPL, neither party will use the trademark "Creative Commons" or any related trademark or logo of Creative Commons without the prior written consent of Creative Commons. Any permitted use will be in compliance with Creative Commons' then-current trademark usage guidelines, as may be published on its website or otherwise made available upon request from time to time.

Creative Commons may be contacted at <http://creativecommons.org/>.

Sun Java Message Service 1.0.2 License

License Agreement for Java(TM) Message Service (JMS) 1.0.2b
Sun Microsystems, Inc.

Binary Code License Agreement

READ THE TERMS OF THIS AGREEMENT AND ANY PROVIDED SUPPLEMENTAL LICENSE TERMS (COLLECTIVELY "AGREEMENT") CAREFULLY BEFORE OPENING THE SOFTWARE MEDIA PACKAGE. BY OPENING THE SOFTWARE MEDIA PACKAGE, YOU AGREE TO THE TERMS OF THIS AGREEMENT. IF YOU ARE ACCESSING THE SOFTWARE ELECTRONICALLY, INDICATE YOUR ACCEPTANCE OF THESE TERMS BY SELECTING THE "ACCEPT" BUTTON AT THE END OF THIS AGREEMENT. IF YOU DO NOT AGREE TO ALL THESE TERMS, PROMPTLY RETURN THE UNUSED SOFTWARE TO YOUR PLACE OF PURCHASE FOR A REFUND OR, IF THE SOFTWARE IS ACCESSED ELECTRONICALLY, SELECT THE "DECLINE" BUTTON AT THE END OF THIS AGREEMENT. 1. LICENSE TO USE. Sun grants you a non-exclusive and non-transferable license for the internal use only of the accompanying software and documentation and any error corrections provided by Sun (collectively "Software"), by the number of users and the class of computer hardware for which the corresponding fee has been paid.

2. RESTRICTIONS. Software is confidential and copyrighted. Title to Software and all associated intellectual property rights is retained by Sun and/or its licensors. Except as specifically authorized in any Supplemental License Terms, you may not make copies of Software, other than a single copy of Software for archival purposes. Unless enforcement is prohibited by applicable law, you may not modify, decompile, or reverse engineer Software. You acknowledge that Software is not designed, licensed or intended for use in the design, construction, operation or maintenance of any nuclear facility. Sun disclaims any express or implied warranty of fitness for such uses. No right, title or interest in or to any trademark, service mark, logo or trade name of Sun or its licensors is granted under this Agreement.

3. LIMITED WARRANTY. Sun warrants to you that for a period of ninety (90) days from the date of purchase, as evidenced by a copy of the receipt, the media on which Software is furnished (if any) will be free of defects in materials and workmanship under normal use. Except for the foregoing, Software is provided "AS IS". Your exclusive remedy and Sun's entire liability under this limited warranty will be at Sun's option to replace Software media or refund the fee paid for Software.

4. DISCLAIMER OF WARRANTY. UNLESS SPECIFIED IN THIS AGREEMENT, ALL EXPRESS OR IMPLIED CONDITIONS, REPRESENTATIONS AND WARRANTIES, INCLUDING ANY IMPLIED WARRANTY OF MERCHANTABILITY, FITNESS FOR A PARTICULAR PURPOSE OR NON-INFRINGEMENT ARE DISCLAIMED, EXCEPT TO THE EXTENT THAT THESE DISCLAIMERS ARE HELD TO BE LEGALLY INVALID.

5. LIMITATION OF LIABILITY. TO THE EXTENT NOT PROHIBITED BY LAW, IN NO EVENT WILL SUN OR ITS LICENSORS BE LIABLE FOR ANY LOST REVENUE, PROFIT OR DATA, OR FOR SPECIAL, INDIRECT, CONSEQUENTIAL, INCIDENTAL OR PUNITIVE DAMAGES, HOWEVER CAUSED REGARDLESS OF THE THEORY OF LIABILITY, ARISING OUT OF OR RELATED TO THE USE OF OR INABILITY TO USE SOFTWARE, EVEN IF SUN HAS BEEN ADVISED OF THE POSSIBILITY OF SUCH DAMAGES. In no event will Sun's liability to you, whether in contract, tort (including negligence), or otherwise, exceed the amount paid by you for Software under this Agreement. The foregoing limitations will apply even if the above stated warranty fails of its essential purpose.

6. Termination. This Agreement is effective until terminated. You may terminate this Agreement at any time by destroying all copies of Software. This Agreement will terminate immediately without notice from Sun if you fail to comply with any provision of this Agreement. Upon Termination, you must destroy all copies of Software.

7. Export Regulations. All Software and technical data delivered under this Agreement are subject to US export control laws and may be subject to export or import regulations in other countries. You agree to comply strictly with all such laws and regulations and acknowledge that you have the responsibility to obtain such licenses to export, re-export, or import as may be required after delivery to you.

8. U.S. Government Restricted Rights. If Software is being acquired by or on behalf of the U.S. Government or by a U.S. Government prime contractor or subcontractor (at any tier), then the Government's rights in Software and accompanying documentation will be only as set forth in this Agreement; this is in accordance with 48 CFR 227.7201 through 227.7202-4 (for Department of Defense (DOD) acquisitions) and with 48 CFR 2.101 and 12.212 (for non-DOD acquisitions).

9. Governing Law. Any action related to this Agreement will be governed by California law and controlling U.S. federal law. No choice of law rules of any jurisdiction will apply.

10. Severability. If any provision of this Agreement is held to be unenforceable, this Agreement will remain in effect with the provision omitted, unless omission would frustrate the intent of the parties, in which case this Agreement will immediately terminate.

11. Integration. This Agreement is the entire agreement between you and Sun relating to its subject matter. It supersedes all prior or contemporaneous oral or written communications, proposals, representations and warranties and prevails over any conflicting or additional terms of any quote, order, acknowledgment, or other communication between the parties relating to its subject matter during the term of this Agreement. No modification of this Agreement will be binding, unless in writing and signed by an authorized representative of each party.

JAVA(TM) INTERFACE CLASSES

JAVA MESSAGE SERVICE (JMS), VERSION 1.0.2

SUPPLEMENTAL LICENSE TERMS

These supplemental license terms ("Supplemental Terms") add to or modify the terms of the Binary Code License Agreement (collectively, the "Agreement"). Capitalized terms not defined in these Supplemental Terms shall have the same meanings ascribed to them in the Agreement. These Supplemental Terms shall supersede any inconsistent or conflicting terms in the Agreement, or in any license contained within the Software. 1. Software Internal Use and Development License Grant. Subject to the terms and conditions of this Agreement, including, but not limited to Section 3 (Java(TM) Technology Restrictions) of these Supplemental Terms, Sun grants you a non-exclusive, non-transferable, limited license to reproduce internally and use internally the binary form of the Software, complete and unmodified, for the sole purpose of designing, developing and testing your Java applets and applications ("Programs").

2. License to Distribute Software. In addition to the license granted in Section 1 (Software Internal Use and Development License Grant) of these Supplemental Terms, subject to the terms and conditions of this Agreement, including but not limited to Section 3 (Java Technology Restrictions), Sun grants you a non-exclusive, non-transferable, limited license to reproduce and distribute the Software in binary form only, provided that you

- i. distribute the Software complete and unmodified and only bundled as part of your Programs,
- ii. do not distribute additional software intended to replace any component(s) of the Software,
- iii. do not remove or alter any proprietary legends or notices contained in the Software,

iv. only distribute the Software subject to a license agreement that protects Sun's interests consistent with the terms contained in this Agreement, and

v. agree to defend and indemnify Sun and its licensors from and against any damages, costs, liabilities, settlement amounts and/or expenses (including attorneys' fees) incurred in connection with any claim, lawsuit or action by any third party that arises or results from the use or distribution of any and all Programs and/or Software.

3. Java Technology Restrictions. You may not modify the Java Platform Interface ("JPI", identified as classes contained within the "java" package or any subpackages of the "java" package), by creating additional classes within the JPI or otherwise causing the addition to or modification of the classes in the JPI. In the event that you create an additional class and associated API(s) which extends the functionality of the Java Platform, and

ii. is exposed to third party software developers for the purpose of developing additional software which invokes such additional API, you must promptly publish broadly an accurate specification for such API for free use by all developers. You may not create, or authorize your licensees to create additional classes, interfaces, or subpackages that are in any way identified as "java", "javax", "sun" or similar convention as specified by Sun in any naming convention designation.

4. Trademarks and Logos. You acknowledge and agree as between you and Sun that Sun owns the SUN, SOLARIS, JAVA, JINI, FORTE, STAROFFICE, STARPORTAL and iPLANET trademarks and all SUN, SOLARIS, JAVA, JINI, FORTE, STAROFFICE, STARPORTAL and iPLANET-related trademarks, service marks, logos and other brand designations ("Sun Marks"), and you agree to comply with the Sun Trademark and Logo Usage Requirements currently located at <http://www.sun.com/policies/trademarks>. Any use you make of the Sun Marks inures to Sun's benefit.

5. Source Code. Software may contain source code that is provided solely for reference purposes pursuant to the terms of this Agreement. Source code may not be redistributed unless expressly provided for in this Agreement.

6. Termination for Infringement. Either party may terminate this Agreement immediately should any Software become, or in either party's opinion be likely to become, the subject of a claim of infringement of any intellectual property right.

For inquiries please contact: Sun Microsystems, Inc. 901 San Antonio Road, Palo Alto, California 94303

(Form ID#011801)

Head Office

86 Cheonggyecheon-ro Jung-gu Seoul 04541 Korea
Tel +82.2.729.5277, 5254 Fax +82.2.729.5489
www.hanwha-security.com

Hanwha Techwin America

500 Frank W. Burr Blvd. Suite 43 Teaneck, NJ 07666
Toll Free +1.877.213.1222 Direct +1.201.325.6920
Fax +1.201.373.0124

Hanwha Techwin Europe

Heriot House, Heriot Road, Chertsey, Surrey, KT16 9DT, United Kingdom
Tel +44.1932.57.8100 Fax +44.1932.57.8101
